

LEGEN



2026 PRODUCT CATALOG

POLYURETHANE, PVC Column Wrap

Legen—The Innovation Leader in Polyurethane Decorative Materials

As a prominent manufacturer in the polyurethane decorative materials sector, Legen has over 30 years of deep expertise in product design, manufacturing, and process & product innovation. Leveraging our industry heritage, we offer thousands of decorative millwork accents for global clients — covering moldings, trims, shutters, beams, and more across indoor & outdoor spaces. Our artistic products unlock boundless design possibilities, catering to custom needs for all styles and scenarios.

Core Product Advantages Unmatched Durability: Crafted from lightweight yet high-strength polyurethane, our products resist warping, cracking, moisture, and insect infestation. They retain long-lasting beauty even in outdoor environments, with extremely low maintenance costs.

Hassle-Free Installation: Products feature strong adaptability and user-friendly design, enabling easy decorative upgrades for both indoor and outdoor spaces.

Flexible Processing: Can be cut and trimmed using standard woodworking tools (table saws, circular saws, jigsaws, etc.), supporting personalized size requirements.

(Installation instructions for all Legen products are available on our official website: www.legenpu.com/Catalog.html)

Legen

US UL GREENGUARD GOLDEN VALUE & LEGEN PART SGS MEASURED VALUE

Criteria	Unit	UL GREENGUARD Golden	Legen part SGS measured
Total Aldehydes(B)	ppb	43	2.45
TVOC(A)	μg/m ³	220	25
Formaldehyde	μg/m ³	9	3
methyl benzene	μg/m ³	751	3
Xylene mixture of isomer	μg/m ³	865	4
n-hexane	μg/m ³	1755	3
cyclohexane	μg/m ³	3429	5
4-Phenylcyclohexene	μg/m ³	Cannot detection	Not detection
Particle Matter less than 10 μm @/ PM 10	μg/m ³	20	Not applicable



Product Characteristics



Insect and Mildew Resistance
Low water absorption. Could not get moldy even put in water for long time; Also can effectively prevent the damage of termites and insects to products.



Dimensional Stability
Small thermal expansion and cold contraction, excellent dimensional stability



Profiling Performance
Superb mold technology enables the product surface possessing realistic wood-grained texture.



Eco-friendly Material
Adopted full water foaming system and water-based paint, all the products meet the EU SGS-SVHC standards, VOC content lower than the EU and American standards.



Durability
Subsequently formed polyurethane and the previously formed waterborne film can be perfectly adhered together without peeling off and discoloration · same life as building.



Customizable
Customizing customers' personalized products according to the requirements.

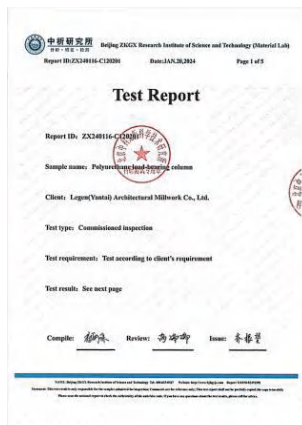

Multiple Color Options for Woodgrain PUR

Real wood look, urethane strength. Our durable polyurethane collection features authentic woodgrain textures and a versatile range—including Shutters, Corbels, Louvers, and Beams. Create a distinctive, long-lasting look for any home with the perfect blend of style and performance.

LEGEN specializes in polyurethane: designing innovative products with precision molding technology.

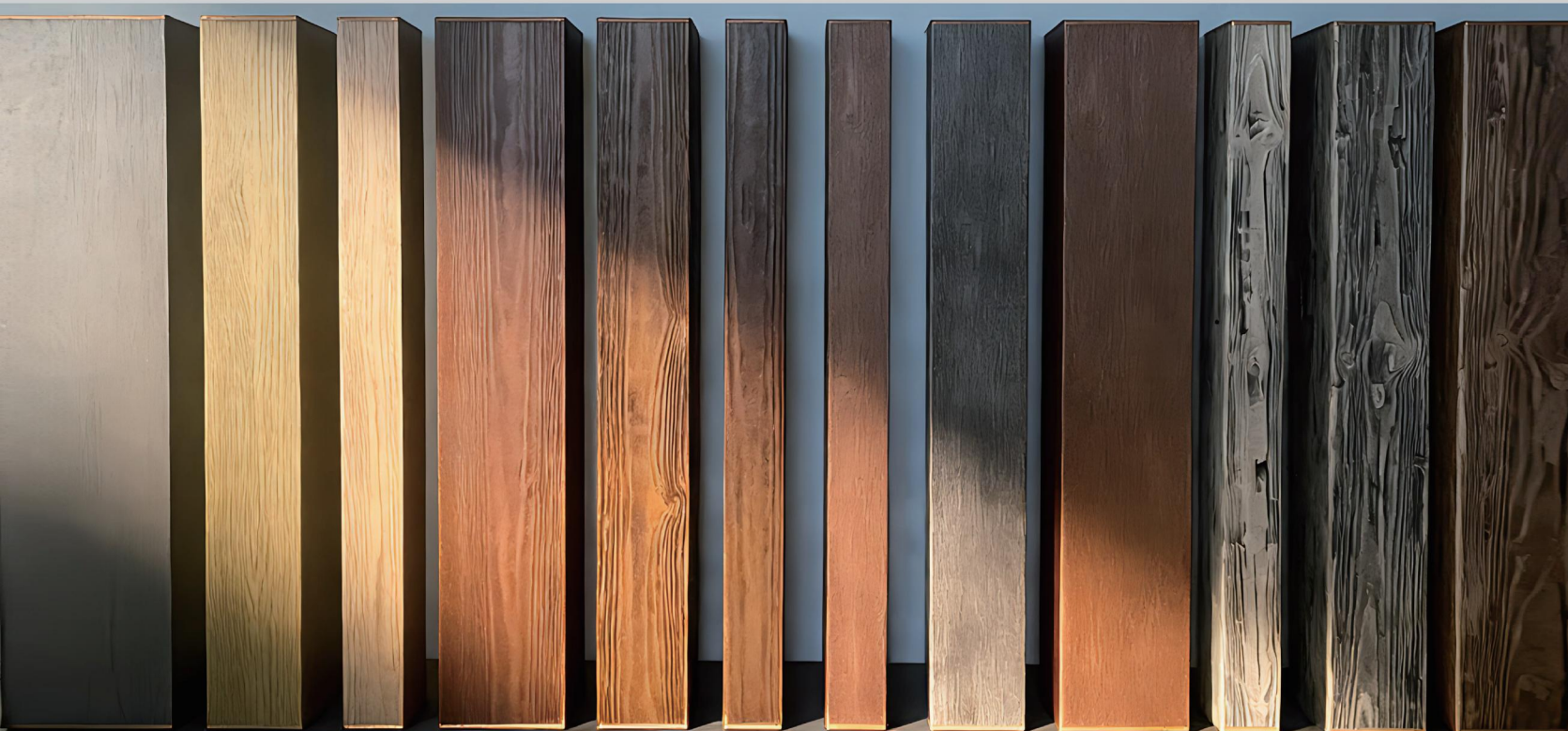



Black



Dark Tan



Smoky Gray



Light beige brown



Early American



Bronze



Caramel



Vintage Umber



Dark Golden



Teak



Charcoal Chestnut



Light Brown

The Beauty of Urethane



MOISTURE RESISTANT

Urethane millwork's closed cell structure prevents water penetration and absorption.



SPLINTER RESISTANT

Urethane millwork does not splinter like wood. If surface blemishes occur during installation, they can be easily repaired with ordinary plastic wood filler.

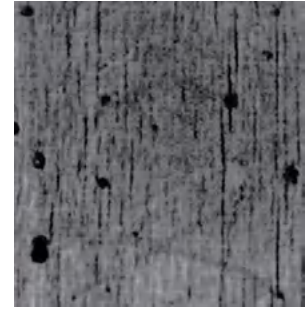

INSECT RESISTANT

Urethane millwork provides a practical alternative if you want the look of real wood detailing for your projects, but live in an area that is prone to insect infestation. Urethane Millwork/Wood Considerations.

Urethane Millwork VS. Wood Considerations

	URETHANE MILLWORK	WOOD
Quality composition	Consistent quality; No waste; Consistent finish	Quality varies; Knots and gouges result in waste; Blotching, Disappearing grain and discoloration can occur
Versatility	All products suitable for interior or exterior application	Different grade of material and finish required for outdoor application
Durability	Resists warping or splitting; Resists weather damage and insect infestation	Can warp; Susceptible to splitting; Susceptible to rotting and insect damage
Labor Savings	Requires no sanding, Priming or sealing; Moulding easy to install	Requires sanding, Priming and sealing; Intricate moulding require multiple application process incurring high labor costs
Value	Reasonable, stable price; Long lasting good looks with low maintenance; Increases home/building resale value	Market price fluctuates; Requires periodic maintenance; May need replacement/refinishing as damage occurs

CONTENTS

7 Window & Door Trim

Crossheads & Pediments
Pilasters
Keystones
Window & Door Trim

34 Shutters

Woodgrain Shutters
Louvered Shutters
Woodgrain Thick Shutters

62 Moulding

Smooth & Woodgrain Flat Trim
Moulding

84 Ceiling Medallions

87 Louvers & Gable Vents

Decorative & Functional Smooth Louvers
Decorative & Functional Woodgrain
Louvers

100 Decorative Millwork

119 Gable Pediment

130 Beams

Faux Wood & Smooth Beams
Beam Boards & Assistance
Rafter Tails

150 Balustrades & Columns

Balusters
Railing
Newel Posts
Columns

163 Column Wrap

PVC Column Wrap
PUR Woodgrain
Column Wrap
PUR Column Base

176 Woodgrain Siding



WINDOW & DOOR TRIM

CROSSHEADS

6" Classic Crosshead

Part#	Bottom Width(A)	Part#	Bottom Width(A)
WH24X6	24"(610mm)	WH60X6	60"(1524mm)
WH28X6	28"(711mm)	WH64X6	64"(1626mm)
WH30X6	30"(762mm)	WH66X6	66"(1676mm)
WH31X6	31"(787mm)	WH67X6	67"(1702mm)
WH32X6	32"(813mm)	WH68X6	68"(1727mm)
WH33X6	33"(838mm)	WH72X6	72"(1829mm)
WH34X6	34"(864mm)	WH73X6	73"(1854mm)
WH35X6	35"(889mm)	WH74X6	74"(1880mm)
WH36X6	36"(914mm)	WH76X6	76"(1930mm)
WH37X6	37"(940mm)	WH78X6	78"(1981mm)
WH38X6	38"(965mm)	WH79X6	79"(2007mm)
WH40X6	40"(1016mm)	WH80.5X6	80-½"(2045mm)
WH41X6	41"(1041mm)	WH80X6	80"(2032mm)
WH43X6	43"(1092mm)	WH84X6	84"(2134mm)
WH44X6	44"(1118mm)	WH86X6	86"(2184mm)
WH46X6	46"(1168mm)	WH87X6	87"(2210mm)
WH47X6	47"(1194mm)	WH96X6	96"(2438mm)
WH48X6	48"(1219mm)	WH100X6	100"(2540mm)
WH50X6	50"(1270mm)	WH103X6	103"(2616mm)
WH51X6	51"(1295mm)	WH104X6	104"(2642mm)
WH52X6	52"(1321mm)	WH108X6	108"(2743mm)
WH54X6	54"(1372mm)	WH110X6	110"(2794mm)
WH56X6	56"(1422mm)	WH144X6	144"(3658mm)

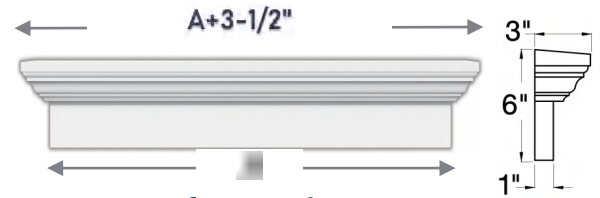

Standard



K(Keystone)



T(Trim Strip)



D(Dentil Trim)

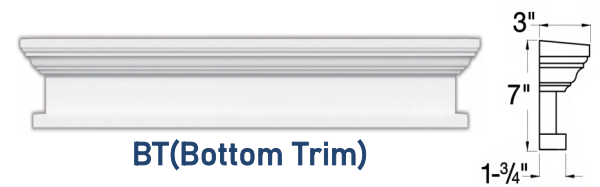

BT(Bottom Trim)

Part Number Logic

WH 24 X 6 -

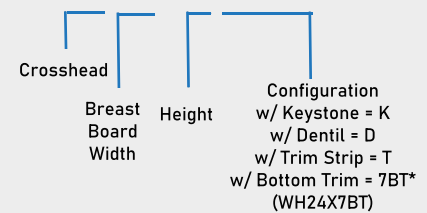

*Bottom trim adds 1" to overall height.

CROSSHEADS

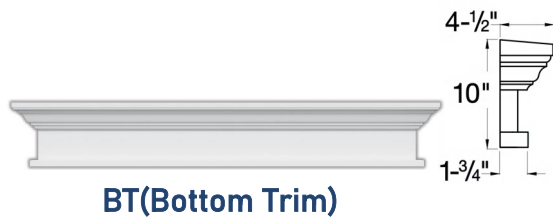
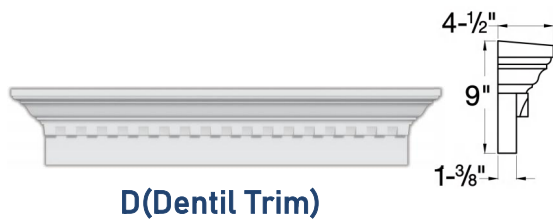
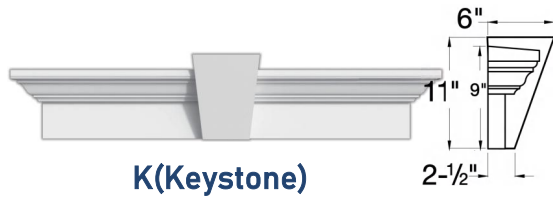
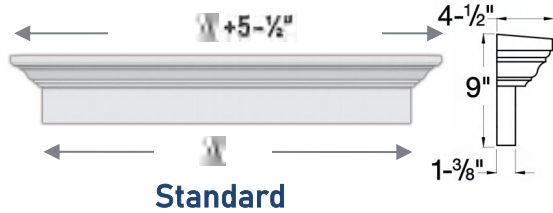

Part Number Logic

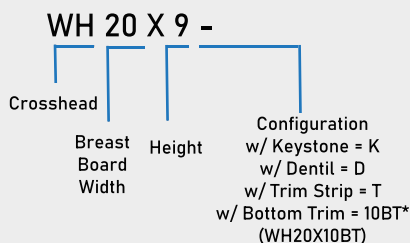

*Bottom trim adds 1" to overall height.

9" Classic Crosshead

Part#	Bottom Width(A)	Part#	Bottom Width(A)
WH20X9	20"(508mm)	WH70X9	70"(1778mm)
WH24X9	24"(610mm)	WH72X9	72"(1829mm)
WH25X9	25"(635mm)	WH73X9	73"(1854mm)
WH26X9	26"(660mm)	WH74X9	74"(1880mm)
WH27X9	27"(686mm)	WH75X9	75"(1905mm)
WH28X9	28"(711mm)	WH76X9	76"(1930mm)
WH29X9	29"(737mm)	WH77X9	77"(1956mm)
WH30X9	30"(762mm)	WH78X9	78"(1981mm)
WH32X9	32"(813mm)	WH80X9	80"(2032mm)
WH33X9	33"(838mm)	WH81X9	81"(2057mm)
WH34X9	34"(864mm)	WH82X9	82"(2083mm)
WH35X9	35"(889mm)	WH84X9	84"(2134mm)
WH36X9	36"(914mm)	WH85x9	85"(2159mm)
WH37X9	37"(940mm)	WH86X9	86"(2184mm)
WH38X9	38"(965mm)	WH88X9	88"(2235mm)
WH40X9	40"(1016mm)	WH90X9	90"(2286mm)
WH41X9	41"(1041mm)	WH93X9	93"(2362mm)
WH42X9	42"(1067mm)	WH96X9	96"(2438mm)
WH43X9	43"(1092mm)	WH99X9	99"(2515mm)
WH44X9	44"(1118mm)	WH100X9	100"(2540mm)
WH45X9	45"(1143mm)	WH101X9	101"(2565mm)
WH46X9	46"(1168mm)	WH103X9	103"(2616mm)
WH48X9	48"(1219mm)	WH104X9	104"(2642mm)
WH49X9	49"(1245mm)	WH108X9	108"(2743mm)
WH50X9	50"(1270mm)	WH110X9	110"(2794mm)
WH54X9	54"(1372mm)	WH112X9	112"(2845mm)
WH56X9	56"(1422mm)	WH113X9	113"(2870mm)
WH58X9	58"(1473mm)	WH120X9	120"(3048mm)
WH60x9	60"(1524mm)	WH124X9	124"(3150mm)
WH62X9	62"(1575mm)	WH144X9	144"(3658mm)
WH64X9	64"(1626mm)	WH192X9	192"(4877mm)
WH65X9	65"(1651mm)	WH196X9	196"(4978mm)
WH66X9	66"(1676mm)	WH197X9	197"(5004mm)
WH67X9	67"(1702mm)	WH200X9	200"(5080mm)
WH68X9	68"(1727mm)	WH204X9	204"(5182mm)
WH69X9	69"(1753mm)	WH207X9	207"(5258mm)

CROSSHEADS

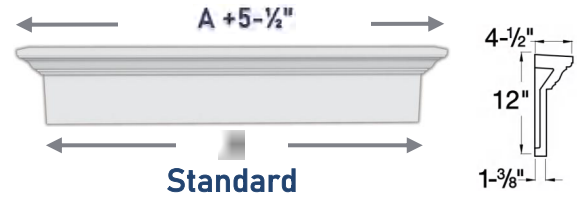

12"Classic Crosshead

Part#	Bottom Width(A)
WH36X12	36"(914mm)
WH40X12	40"(1016mm)
WH44X12	44"(1118mm)
WH48X12	48"(1219mm)
WH54X12	54"(1372mm)
WH56X12	56"(1422mm)
WH64X12	64"(1626mm)
WH72X12	72"(1829mm)
WH96X12	96"(2438mm)
WH102X12	102"(2591mm)
WH104X12	104"(2642mm)
WH144X12	144"(3658mm)
WH200X12	200"(5080mm)
WH203X12	203"(5156mm)
WH213X12	213"(5410mm)

Part Number Logic

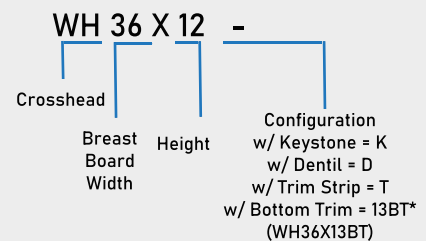

*Bottom trim adds 1" to overall height.

CROSSHEADS

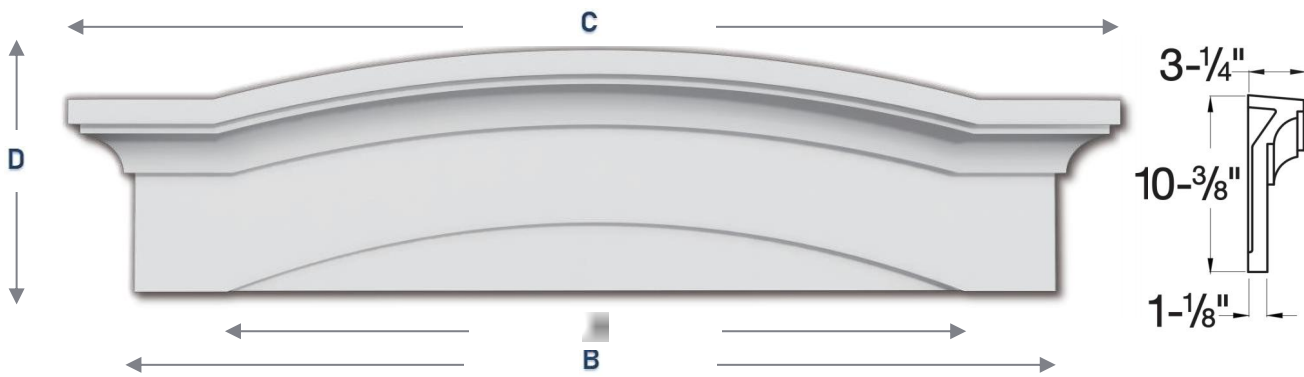

Standard



K(Keystone)

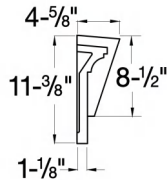

BT(Bottom Trim)

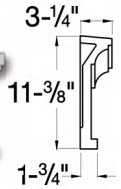

Bottom Trim adds 1 (25mm) to overall height.

10" Eyebrow Crosshead

Part#	Inside Width(A)	Bottom Width(B)	Overall Width(C)	Height(D)	Part# w/Keystone	Part# w/Bottom trim
WHS G28X10	28"(711mm)	37- ¹ / ₈ "(946mm)	41- ¹ / ₂ "(1054mm)	10- ³ / ₈ "(264mm)	WHS G28X10K	WHS G28X11BT
WHS G30X10	29- ⁷ / ₈ "(759mm)	39- ¹ / ₈ "(994mm)	43- ³ / ₈ "(1102mm)	10- ³ / ₈ "(264mm)	WHS G30X10K	WHS G30X11BT
WHS G34X10	34"(864mm)	44"(1626mm)	48- ¹ / ₂ "(1226mm)	10- ³ / ₈ "(264mm)	WHS G34X10K	WHS G34X11BT
WHS G36X10	36"(914mm)	45"(1143mm)	49- ¹ / ₂ "(1251mm)	10- ³ / ₈ "(264mm)	WHS G36X10K	WHS G36X11BT
WHS G43X10	43"(1092mm)	48"(1219mm)	52- ¹ / ₂ "(1327mm)	10- ³ / ₈ "(264mm)	WHS G43X10K	WHS G43X11BT
WHS G44X10	44"(1626mm)	49"(1245mm)	53- ¹ / ₂ "(1353mm)	10- ³ / ₈ "(264mm)	WHS G44X10K	WHS G44X11BT
WHS G64X10	64"(1626mm)	73- ¹ / ₂ "(1861mm)	77- ¹ / ₂ "(1969mm)	10- ³ / ₈ "(264mm)	WHS G64X10K	WHS G64X11BT
WHS G72X10	72"(1829mm)	81"(2057mm)	85- ¹ / ₂ "(2165mm)	10- ³ / ₈ "(264mm)	WHS G72X10K	WHS G72X11BT

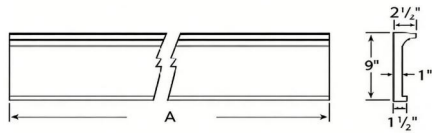

CROSSHEADS



Craftman Cove Crosshead

Part#	Overall Width (A)
CCCD36X9BT	36" (914mm)
CCCD48X9BT	48" (1219mm)
CCCD144X9BT	144 - 3/8" (3667mm)
CCCD216X9BT	216 - 5/8" (5502mm)

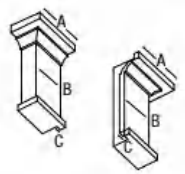
Craftman Cove End Caps

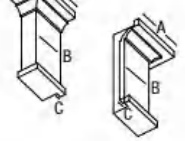
Part#	Height (A)	Projection(B)	Length (C)	
 	CCEC4X9BT	9" (229mm)	3" (76mm)	5" (127mm)
 	CCEC6X9BT	9" (229mm)	3" (76mm)	7" (178mm)

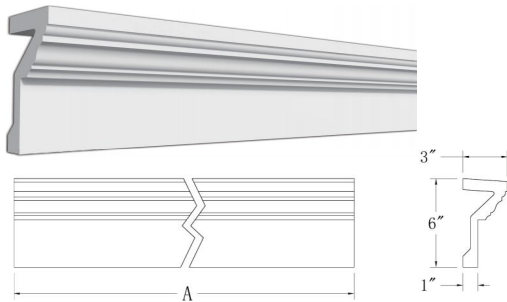
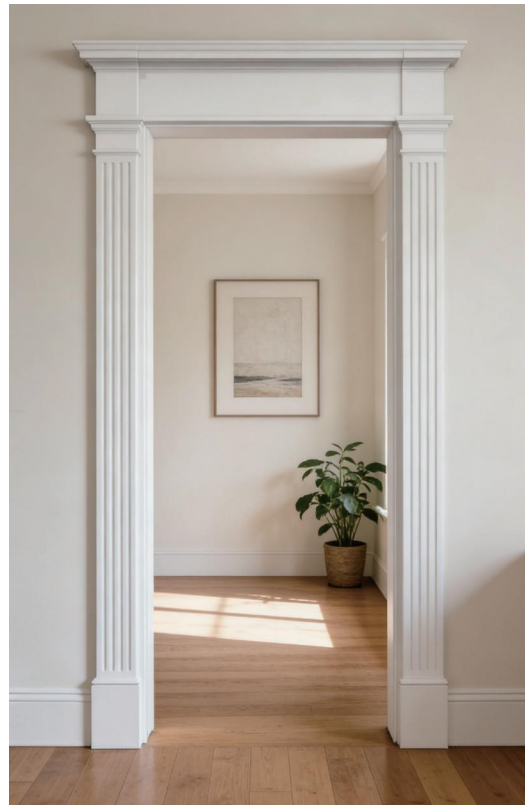

CROSSHEADS



Distinction Crosshead

Part#	Part#	Overall Width (A)
CCD36X6	CCD36X9	36" (914mm)
CCD48X6	CCD48X9	48" (1219mm)
CCD144X6	CCD144X9	144- $\frac{3}{8}$ " (3667mm)
CCD216X6	CCD216X9	216- $\frac{5}{8}$ " (5502mm)

Craftman Cove End Caps

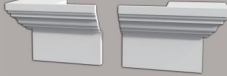
Part#	Overall Width(A)	Breast Board Width(B)	Rabbit Width (C)
 CEC4X6	5-5/16" (135mm)	3-1/2" (89mm)	1" (25mm)
 CEC4X9	6-3/4" (159mm)	3-1/2" (89mm)	1" (25mm)
 CEC7X6	8-13/16" (224mm)	7" (178mm)	4" (102mm)
 CEC7X9	9-3/4" (248mm)	7" (178mm)	4" (102mm)

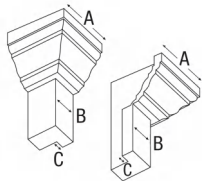

CROSSHEADS

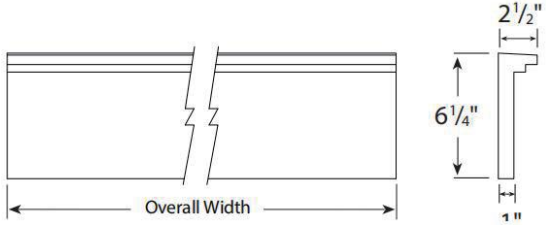

Distinction Step Crosshead

Part#	Overall Width
CCSD36X6	36" (914mm)
CCSD48X6	48" (1219mm)
CCSD144X6	144 - 3/8" (3667mm)
CCSD216X6	216 - 5/8" (5502mm)

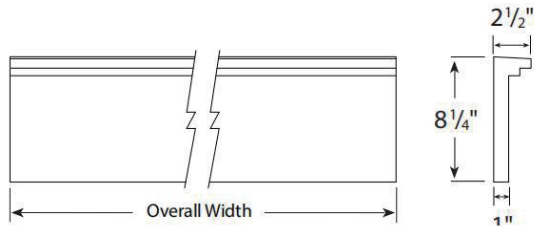



Distinction Step Crosshead

Part#	Overall Width
CCSD36X8	36" (914mm)
CCSD48X8	48" (1219mm)
CCSD144X8	144 - 3/8" (3667mm)
CCSD216X8	216 - 5/8" (5502mm)



Distinction Accessories

Accessory	6"Height	9"Height
 Bottom Trim	MD716-12	MD758-12
 Keystone	K6M	K9M

CROSSHEADS

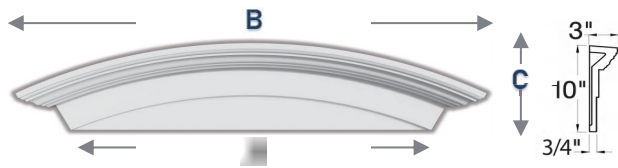

Standard



K(Keystone)

6" Crosshead Arch

Part#	Bottom Width(A)	Overall Width(B)	Height(C)	Part# w/Keystone
WH6AR34X10	34"(864mm)	42-7/8"(1089mm)	10"(254mm)	WH6AR34X10K



Standard



K(Keystone)



BT(Bottom Trim)

Bottom Trim adds 1 (25mm) to overall height.

9" Crosshead Arch

Part#	Bottom Width(A)	Overall Width(B)	Height(C)	Part# w/Keystone	Part# w/Bottom trim
WHAR33X14	33"(838mm)	48-1/8"(1222mm)	14"(356mm)	WHAR33X14K	WHAR33X15BT
WHAR36X13	36"(914mm)	49-1/4"(1251mm)	13"(330mm)	WHAR36X13K	WHAR36X14BT
WHAR43X13	43"(1092mm)	55-1/4"(1403mm)	13"(330mm)	WHAR43X13K	WHAR43X14BT
WHAR54X16	54"(1372mm)	68-1/8"(1730mm)	16"(406mm)	WHAR54X16K	WHAR54X17BT
WHAR64X14	64"(1626mm)	75-1/2"(1918mm)	14"(356mm)	WHAR64X14K	WHAR64X15BT
WHAR68X12	68"(1727mm)	77-1/4"(1962mm)	12"(305mm)	WHAR68X12K	WHAR68X13BT
WHAR68X16	68"(1727mm)	77-1/4"(1962mm)	16"(406mm)	WHAR68X16K	WHAR68X17BT
WHAR72X13	72"(1829mm)	82-1/2"(2096mm)	13"(330mm)	WHAR72X13K	WHAR72X14BT
WHAR75X13	75"(1905mm)	84-7/8"(2156mm)	13-3/8"(340mm)	WHAR75X13K	WHAR75X14BT
WHAR80X15	80"(2032mm)	91-1/4"(2318mm)	15"(381mm)	WHAR80X15K	WHAR80X16BT
WHAR84X16	84"(2134mm)	95-3/4"(2432mm)	16"(406mm)	WHAR84X16K	WHAR84X17BT
WHAR89X13	89"(2007mm)	98-3/8"(2499mm)	13"(330mm)	WHAR89X13K	WHAR89X14BT
WHAR97X17	97"(2464mm)	108-3/4"(2762mm)	17"(432mm)	WHAR97X17K	WHAR97X18BT
WHAR101X13	101"(2565mm)	110"(2794mm)	13"(330mm)	WHAR101X13K	WHAR101X14BT
WHAR108X19	108"(2743mm)	119-7/8"(3045mm)	19"(483mm)	WHAR108X19K	WHAR108X20BT

PEDIMENT



Standard

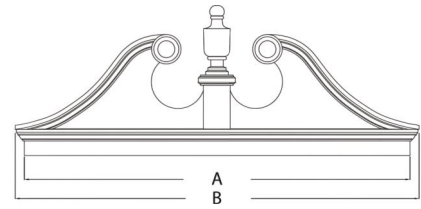
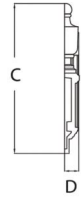

BT(Bottom Trim)

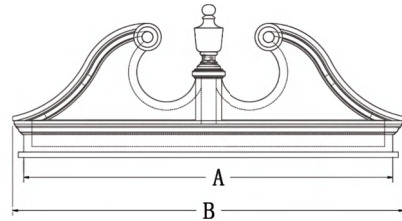
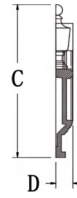

Bottom Trim adds 1 (25mm) to overall height.

Combination Rams Head Pediment

Part#	Bottom Width(A)	Overall Width(B)	Height(C)	Projection(D)	Part# w/Bottom trim
RHP54	54"(1372mm)	58"(1473mm)	23-½"(597mm)	3-⅛"(79mm)	RHP54BT
RHP67	67-½"(1715mm)	71-½"(1816mm)	27"(686mm)	3-⅛"(79mm)	RHP67BT
RHP75	75"(1905mm)	79"(2007mm)	29-⅛"(740mm)	3-⅛"(79mm)	RHP75BT
RHP80	80"(2032mm)	84"(2134mm)	35-¾"(908mm)	3-⅛"(79mm)	RHP80BT
RHP85	85"(2159mm)	89"(2261mm)	33-⅝"(854mm)	3-⅛"(79mm)	RHP85BT

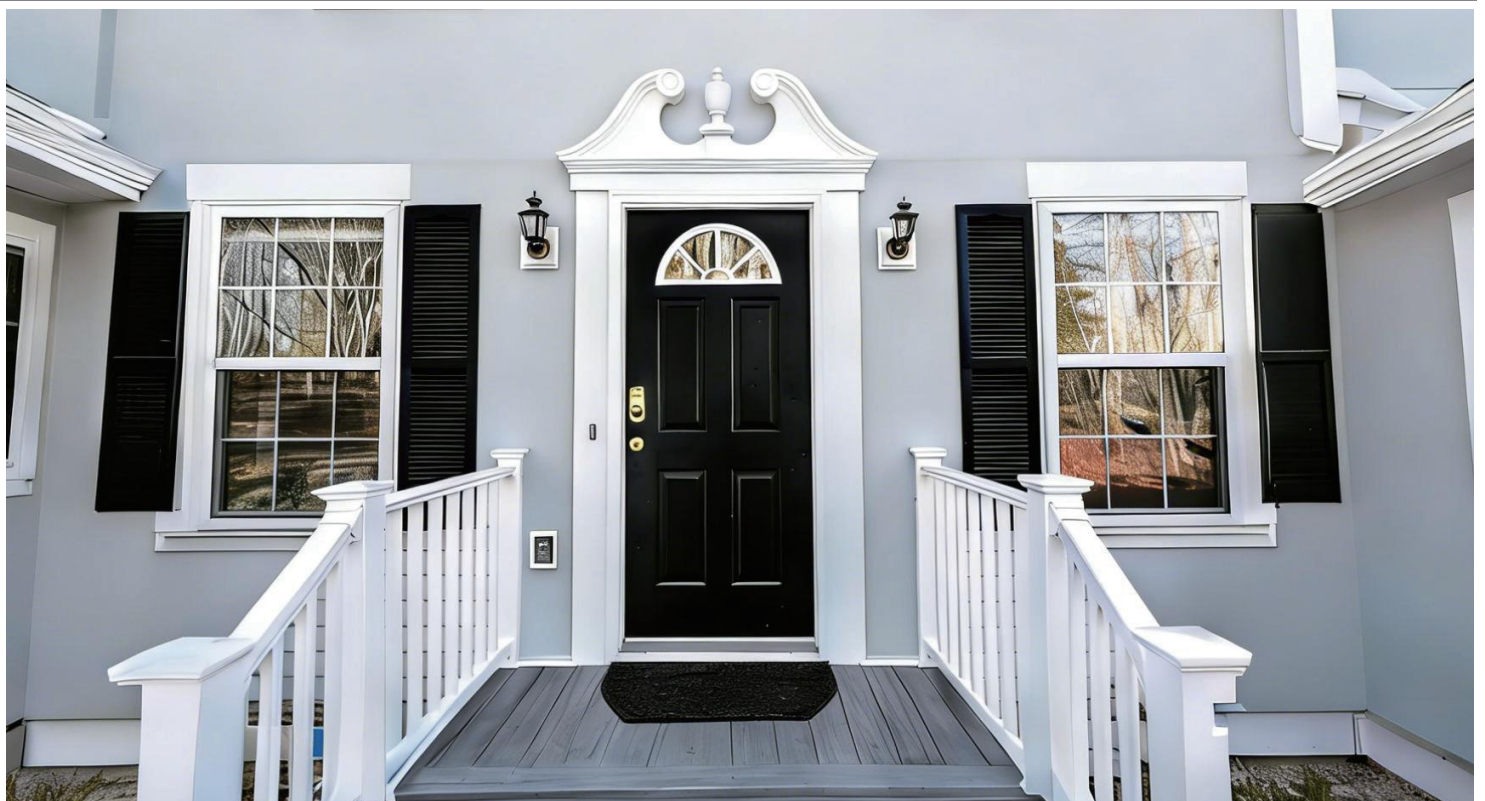

PEDIMENTS

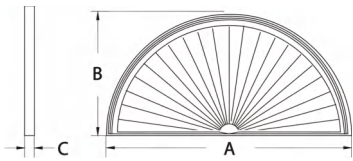

Segment Sunburst

Part#	Width(A)	Height(B)	Projection(C)
HSWH24X12	24"(610mm)	12"(305mm)	1- $\frac{3}{4}$ "(44mm)
HSWH28X14	28"(711mm)	14"(356mm)	1- $\frac{3}{4}$ "(44mm)
HSWH30X15	30"(762mm)	15"(381mm)	1- $\frac{3}{4}$ "(44mm)
HSWH32X16	32"(813mm)	16"(406mm)	1- $\frac{3}{4}$ "(44mm)
HSWH33X17	33- $\frac{5}{8}$ "(854mm)	16- $\frac{3}{4}$ "(425mm)	1- $\frac{3}{4}$ "(44mm)
HSWH36X18	36"(914mm)	18"(457mm)	1- $\frac{3}{4}$ "(44mm)
HSWH37X19	37- $\frac{5}{8}$ "(956mm)	19"(483mm)	1- $\frac{3}{4}$ "(44mm)
HSWH40X20	40"(1016mm)	20"(508mm)	1- $\frac{3}{4}$ "(44mm)
HSWH42X21	42"(1067mm)	21"(533mm)	1- $\frac{3}{4}$ "(44mm)
HSWH44X22	44"(1118mm)	22"(559mm)	1- $\frac{3}{4}$ "(44mm)
HSWH48X24	48"(1219mm)	24"(610mm)	1- $\frac{3}{4}$ "(44mm)
HSWH56X28	56"(1422mm)	28"(711mm)	1- $\frac{3}{4}$ "(44mm)
HSWH60X30	60"(1524mm)	30"(762mm)	1- $\frac{3}{4}$ "(44mm)
HSWH64X32	64"(1626mm)	32"(813mm)	1- $\frac{3}{4}$ "(44mm)
HSWH68X34	68"(1727mm)	34"(864mm)	1- $\frac{3}{4}$ "(44mm)
HSWH72X36	72"(1829mm)	36"(914mm)	1- $\frac{3}{4}$ "(44mm)
HSWH76X38	76"(1930mm)	38"(965mm)	1- $\frac{3}{4}$ "(44mm)
HSWH100X50	100"(2540mm)	50"(1270mm)	1- $\frac{3}{4}$ "(44mm)

Elliptical Sunburst

Part#	Width(A)	Height(B)	Projection(C)
ESWDH76X23	76- $\frac{5}{8}$ "(1953mm)	23"(584mm)	3- $\frac{1}{2}$ "(89mm)

PEDIMENTS



Standard

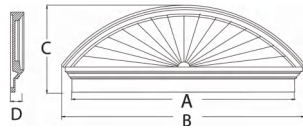

BT(Bottom Trim)



Bottom Trim adds 1 (25mm) to overall height.

Combination Sunburst Pediment

Part#	Bottom Width(A)	Overall Width(B)	Height(C)	Projection(D)	Part# w/Bottom trim
CSP54	54"(1372mm)	58- $\frac{1}{2}$ "(1486mm)	21- $\frac{3}{8}$ "(543mm)	3- $\frac{1}{8}$ "(79mm)	CSP54BT
CSP75	75"(1905mm)	79- $\frac{5}{8}$ "(1794mm)	23- $\frac{3}{8}$ "(603mm)	3- $\frac{1}{8}$ "(79mm)	CSP75BT
CSP80	80"(2032mm)	84- $\frac{5}{8}$ "(2149mm)	25- $\frac{1}{2}$ "(648mm)	3- $\frac{1}{8}$ "(79mm)	CSP80BT
CSP85	85"(2159mm)	89- $\frac{1}{2}$ "(2273mm)	26- $\frac{3}{8}$ "(670mm)	3- $\frac{1}{8}$ "(79mm)	CSP85BT



PEDIMENTS

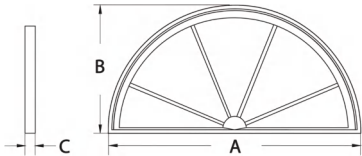

Half-Round Poked Pediment

Part#	Width(A)	Height(B)	Projection(C)
HSP36X18	36"(914mm)	18"(457mm)	1- $\frac{3}{4}$ "(44mm)
HSP48X24	48"(1219mm)	24"(610mm)	1- $\frac{3}{4}$ "(44mm)
HSP72X36	72"(1829mm)	36"(914mm)	1- $\frac{3}{4}$ "(44mm)



Segment Sunburst

Part#	Width(A)	Height(B)	Projection(C)
HSWH36X9	36"(914mm)	9"(229mm)	1- $\frac{3}{4}$ "(44mm)
HSWH48X13	48"(1219mm)	13"(330mm)	1- $\frac{3}{4}$ "(44mm)
HSWH68X14	68"(1727mm)	14"(356mm)	1- $\frac{3}{4}$ "(44mm)
HSWH72X14	72"(1829mm)	14"(356mm)	1- $\frac{3}{4}$ "(44mm)
HSWH76X15	76"(1930mm)	15"(381mm)	1- $\frac{3}{4}$ "(44mm)
HSWH80X15	79- $\frac{1}{2}$ "(2019mm)	15"(381mm)	1- $\frac{3}{4}$ "(44mm)

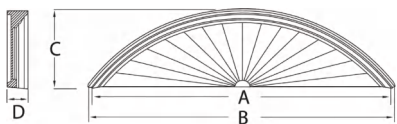

Sunburst Pediment

Part#	Bottom Width(A)	Overall Width(B)	Height(C)	Projection(D)
SP56	55- $\frac{1}{4}$ "(1403mm)	57"(1448mm)	16- $\frac{3}{8}$ "(425mm)	4- $\frac{1}{2}$ "(114mm)
SP667	66- $\frac{3}{4}$ "(1695mm)	69- $\frac{1}{4}$ "(1759mm)	20- $\frac{3}{8}$ "(518mm)	5- $\frac{1}{2}$ "(140mm)
SP86	85- $\frac{5}{8}$ "(2175mm)	87- $\frac{1}{4}$ "(2216mm)	22- $\frac{1}{2}$ "(572mm)	4- $\frac{1}{2}$ "(114mm)
SP91	90- $\frac{1}{2}$ "(2299mm)	92- $\frac{1}{2}$ "(2350mm)	26"(660mm)	4- $\frac{1}{2}$ "(114mm)

PEDIMENTS



Standard

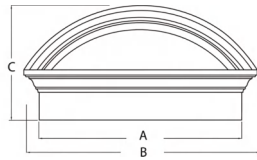
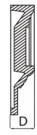

BT(Bottom Trim)

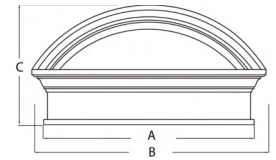

Bottom Trim adds 1 (25mm) to overall height.

Combination Segment Pediment

Part#	Bottom Width(A)	Overall Width(B)	Height(C)	Projection(D)	Part# w/Bottom trim
SAP36	36"(914mm)	41-½"(1054mm)	20"(508mm)	4-½"(114mm)	SAP36BT
SAP48	48"(1219mm)	53-½"(1359mm)	22-½"(572mm)	4-½"(114mm)	SAP48BT
SAP65	65"(1651mm)	70-½"(1791mm)	28-¾"(721mm)	4-½"(114mm)	SAP65BT
SAP84	84"(2134mm)	89-½"(2273mm)	28"(711mm)	4-½"(114mm)	SAP84BT

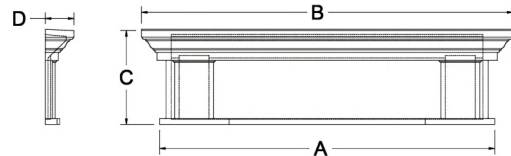

Large Door Crosshead

Part#	Bottom Width(A)	Overall Width(B)	Height(C)	Projection(D)
DH58X18	58"(1473mm)	67-½"(1715mm)	18-¾"(464mm)	5-½"(140mm)
DH62X18	62"(1575mm)	71-½"(1816mm)	18-¾"(464mm)	5-½"(140mm)
DH87X18	87" (2210mm)	96-½"(2451mm)	18-¾"(464mm)	5-½"(140mm)
DH90X18	90-½"(2299mm)	100"(2540mm)	18-¾"(464mm)	5-½"(140mm)
DH94X18	94-½"(2400mm)	104"(2642mm)	18-¾"(464mm)	5-½"(140mm)

PEDIMENTS

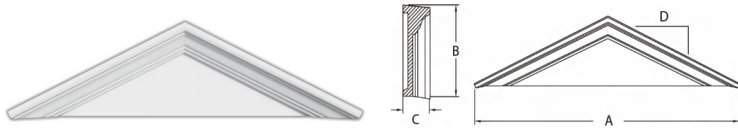

Peaked Cap Pediment

Part#	Bottom Width(A)	Height(B)	Projection(C)	Pitch(D)
PCP56	56-½"(1435mm)	13-⅝"(346mm)	4-½"(114mm)	5-½/12
PCP667	68-½"(1746mm)	23-⅝"(600mm)	5-½"(140mm)	8/12

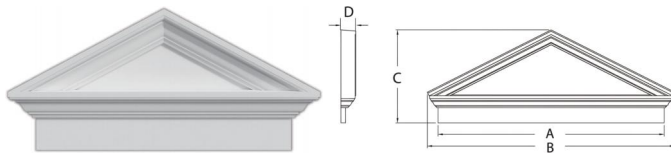

Standard

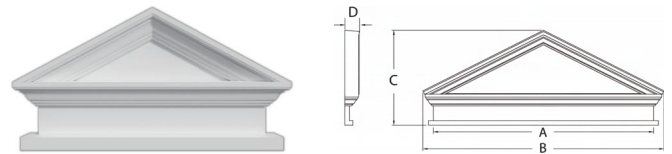

BT(Bottom Trim)

Bottom Trim adds 1 (25mm) to overall height.

Half-Round Sunburst

Part#	Bottom Width(A)	Overall Width(B)	Height(H)	Projection(D)	Part# w/Bottom trim
CCP37	37-⅝"(956mm)	41-¾"(1060mm)	20-½"(521mm)	4-½"(114mm)	CCP37BT

PEDIMENTS

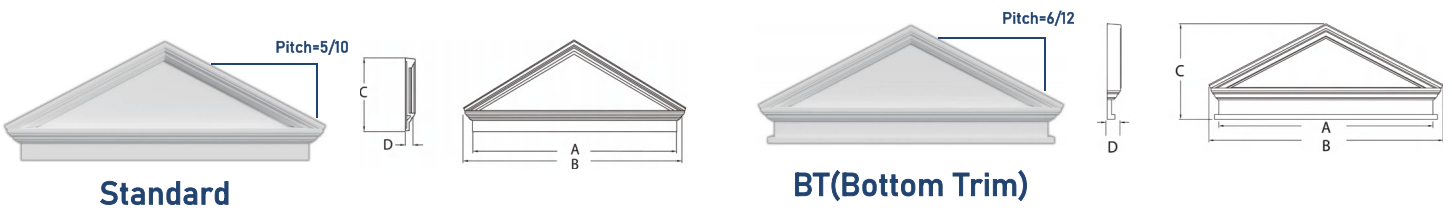

Standard

BT(Bottom Trim)

Bottom Trim adds 1 (25mm) to overall height.

Combination Peaked Cap Pediment

Part#	Bottom Width(A)	Overall Width(B)	Height(C)	Projection(D)	Part# w/Bottom trim
CPCP48	47-½"(1207mm)	52"(1321mm)	19-½"(495mm)	3-⅛"(79mm)	CPCP48BT
CPCP50	50"(1270mm)	54-½"(1384mm)	20-½"(514mm)	3-⅛"(79mm)	CPCP50BT
CPCP54	54"(1372mm)	58-½"(1480mm)	21"(533mm)	3-⅛"(79mm)	CPCP54BT
CPCP58	58"(1473mm)	62-¾"(1584mm)	22"(559mm)	3-⅛"(79mm)	CPCP58BT
CPCP67	67-½"(1715mm)	72"(1829mm)	24-½"(622mm)	3-⅛"(79mm)	CPCP67BT
CPCP75	75"(1905mm)	79-½"(2019mm)	26-½"(667mm)	3-⅛"(79mm)	CPCP75BT
CPCP80	80"(2032mm)	84-½"(2146mm)	27-⅝"(702mm)	3-⅛"(79mm)	CPCP80BT
CPCP85	85"(2159mm)	89-½"(2273mm)	28-¾"(730mm)	3-⅛"(79mm)	CPCP85BT

PEDIMENTS

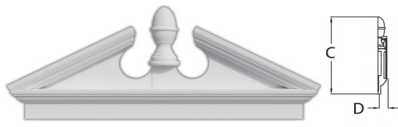

Standard

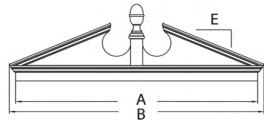

BT(Bottom Trim)

Bottom Trim adds 1 (25mm) to overall height.

Combination Acorn Pediment

Part#	Width(A)	Overall Width(B)	Height(C)	Projection(D)	Pitch(E)	Part# w/Bottom trim
CAP47E	47"(1194mm)	50- ¹ / ₈ "(1273mm)	13- ⁵ / ₈ "(346mm)	2- ¹ / ₈ "(54mm)	5/12	-
CAP50	50"(1270mm)	54- ¹ / ₂ "(1384mm)	21- ¹ / ₈ "(537mm)	3- ¹ / ₈ "(79mm)	6/12	-
CAP54	54"(1372mm)	58- ¹ / ₂ "(1486mm)	21- ³ / ₈ "(543mm)	3- ¹ / ₈ "(79mm)	6/12	CAP54BT
CAP58	58"(1473mm)	62- ¹ / ₂ "(1588mm)	21- ³ / ₈ "(553mm)	3- ¹ / ₈ "(79mm)	6/12	CAP58BT
CAP67	67- ¹ / ₂ "(1715mm)	72"(1829mm)	24- ¹ / ₈ "(613mm)	3"(76mm)	6/12	CAP67BT
CAP75	75"(1905mm)	79- ¹ / ₂ "(2019mm)	25- ¹ / ₈ "(638mm)	3- ¹ / ₈ "(79mm)	6/12	CAP75BT
CAP80	80"(2032mm)	84- ⁷ / ₁₆ "(2145mm)	25- ³ / ₈ "(645mm)	3- ¹ / ₈ "(79mm)	5- ¹ / ₂ /12	CAP80BT
CAP85	85"(2159mm)	89- ³ / ₈ "(2270mm)	28- ³ / ₈ "(721mm)	3- ¹ / ₈ "(79mm)	5/12	CAP85BT

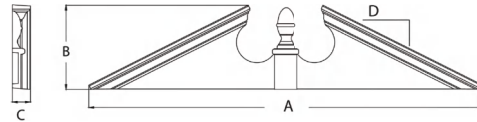
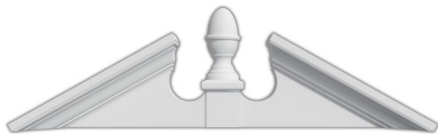

Acorn Pediment

Part#	Width(A)	Height (B)	Projection (C)	Pitch (D)
AP56	57"(1448mm)	16- ⁵ / ₈ "(422mm)	4- ¹ / ₂ "(114mm)	6- ¹ / ₂ /12
AP61	62"(1575mm)	16- ³ / ₈ "(425mm)	4- ¹ / ₂ "(114mm)	7/12
AP667	68- ⁷ / ₈ "(1749mm)	23- ³ / ₈ "(591mm)	5- ¹ / ₂ "(140mm)	12/12
AP86	87- ¹ / ₄ "(2216mm)	24"(610mm)	4- ¹ / ₂ "(114mm)	7/12
AP91	92- ¹ / ₈ "(2340mm)	24- ¹ / ₂ "(622mm)	4- ¹ / ₂ "(114mm)	6/12
AP98	99- ¹ / ₈ "(2518mm)	24- ¹ / ₂ "(622mm)	4- ¹ / ₂ "(114mm)	6/12
AP115	105"-115"*** (2667mm-2921mm)	25- ⁵ / ₈ "(651mm)	4- ¹ / ₂ "(114mm)	6/12

**Adjustable



PEDIMENTS

7" Panel Arch

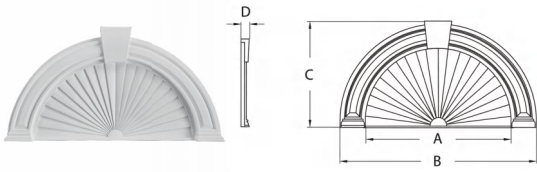

Part#	Inside Width(A)	Overall Width (B)	Height(C)	Projection(D)
AM40X54PSK	40" (1016mm)	54" (1372mm)	29" (737mm)	20" (508mm)

10" Decorative Arch

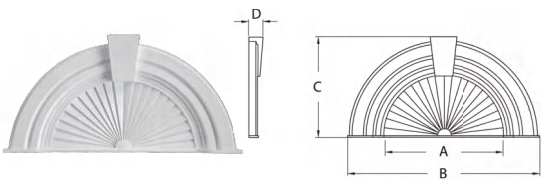

Part#	Inside Width(A)	Overall Width(B)	Height(C)	Projection(D)
AM36X10SK	36" (914mm)	56" (1422mm)	30-1/8" (765mm)	4" (102mm)

Deluxe Victorian Pediment

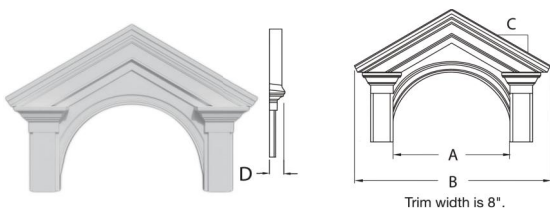

Part#	Inside Width(A)	Overall Width(B)	Pitch(C)	Projection(D)
DVP40	40" (1016mm)	67-1/2" (1708mm)	7/12	5-1/2" (140mm)

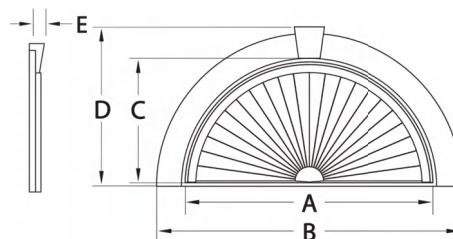

Half-Round Sunburst

Part#	Inside Width(A)	Overall Width (B)	Inside Height(C)	Overall Height(D)	Projection (E)
HSWH36X18-4FK	36" (914mm)	43" (1092mm)	18" (457mm)	22-1/2" (572mm)	2-1/4" (57mm)

PEDIMENTS

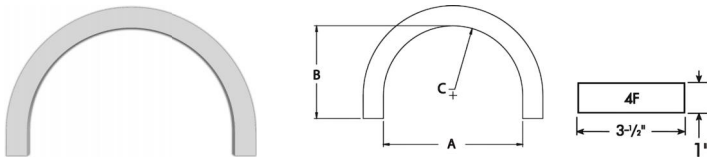

Flat Half-Round Arch Trim

Part#	Flat Width	Inside Width(A)	Inside Height(B)	Radius(C)
AF24X4	3-1/2" (89mm)	24-1/8" (613mm)	16-1/8" (410mm)	12-1/8" (308mm)
AF36X4	3-1/2" (89mm)	36" (914mm)	22" (559mm)	18" (457mm)
AF37X4	3-1/2" (89mm)	37-5/8" (956mm)	22-3/4" (578mm)	18-3/4" (476mm)
AF48X4	3-1/2" (89mm)	48" (1219mm)	28" (711mm)	24" (610mm)
AF72X4	3-1/2" (89mm)	72" (1829mm)	40" (1016mm)	36" (914mm)
AF36X6	5-1/2" (140mm)	36" (914mm)	22" (559mm)	18" (457mm)
AF48X6	5-1/2" (140mm)	48" (1219mm)	28" (711mm)	24" (610mm)

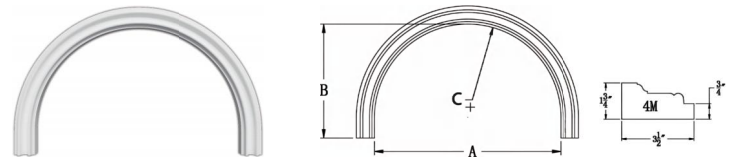

Decorative Half-Round Arch Trim

Part#	Flat Width	Inside Width(A)	Inside Height(B)	Radius(C)
AM36X4	3-1/2" (89mm)	36" (914mm)	22" (559mm)	18" (457mm)
AM48X4	3-1/2" (89mm)	48" (1219mm)	28" (711mm)	24" (610mm)
AM36X6	5-1/2" (140mm)	36" (914mm)	21" (533mm)	18-1/8" (460mm)
AM40X6	5-1/2" (140mm)	40" (1016mm)	24" (610mm)	20" (508mm)
AM48X6	5-1/2" (140mm)	48" (1219mm)	28" (711mm)	24" (610mm)
AM60X6	5-1/2" (140mm)	60" (1524mm)	34" (864mm)	30" (762mm)
AM72X6	5-1/2" (140mm)	72" (1829mm)	40" (1016mm)	36" (914mm)

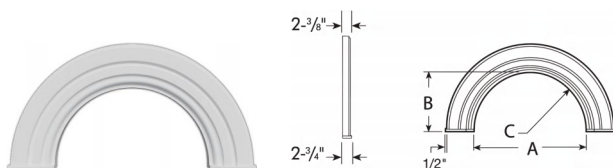

10M Decorative Half-Round Arch Trim

Part#	Flat Width	Inside Width(A)	Inside Height(B)	Radius(C)
AMC36X10	10" (254mm)	18-3/4" (476mm)	36" (914mm)	18" (457mm)
AMC64X10	10" (254mm)	32-3/4" (832mm)	64" (1626mm)	32" (813mm)

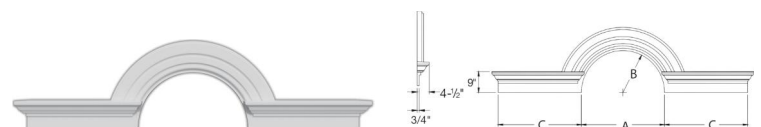

Half-Round Arch Trim with Flankers

Part#	Inside Width(A)	Radius(B)	Flanker Width(C)	Overall Width(D)
AM36X10L108	36" (914mm)	36" (914mm)	18" (457mm)	108" (2743mm)

PLASTERS

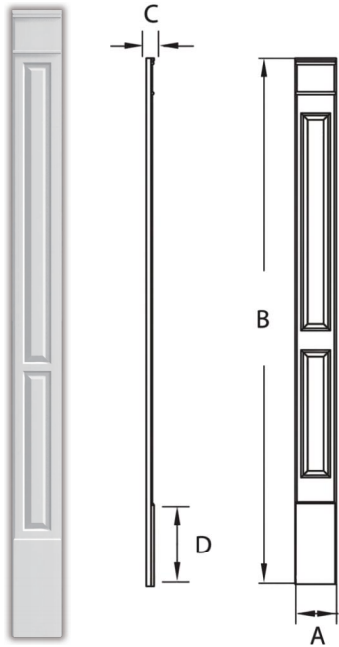

Double Panel Pilaster

Part#	Width(A)	Height(B)	Projection (C)	Plinth Block Height (D)	Plinth
PL5X90DP	5- $\frac{1}{4}$ "(133mm)	90"(2286mm)	1- $\frac{5}{8}$ "(41mm)	10- $\frac{1}{8}$ "(257mm)	Molded
PL7X90DP	7"(178mm)	90"(2286mm)	2- $\frac{1}{2}$ "(64mm)	14- $\frac{1}{4}$ "(362mm)	Molded
PL7X104DP	7"(178mm)	104"(2642mm)	2- $\frac{1}{2}$ "(64mm)	14- $\frac{1}{4}$ "(362mm)	Molded
PL9X90DP	9"(229mm)	90"(2286mm)	3"(76mm)	14- $\frac{1}{2}$ "(368mm)	Molded
PL9X100DP	9"(229mm)	100"(2540mm)	3"(76mm)	14- $\frac{1}{2}$ "(368mm)	Molded
PL11X90DP	11"(279mm)	90"(2286mm)	3- $\frac{1}{2}$ "(89mm)	14- $\frac{1}{2}$ "(368mm)	Molded
PL11X108DP	11"(279mm)	108"(2743mm)	3- $\frac{1}{2}$ "(89mm)	14- $\frac{1}{2}$ "(368mm)	Molded
PL7X90DPE*	7"(178mm)	90"(2286mm)	1- $\frac{1}{4}$ "(32mm)	14- $\frac{1}{4}$ "(362mm)	Molded

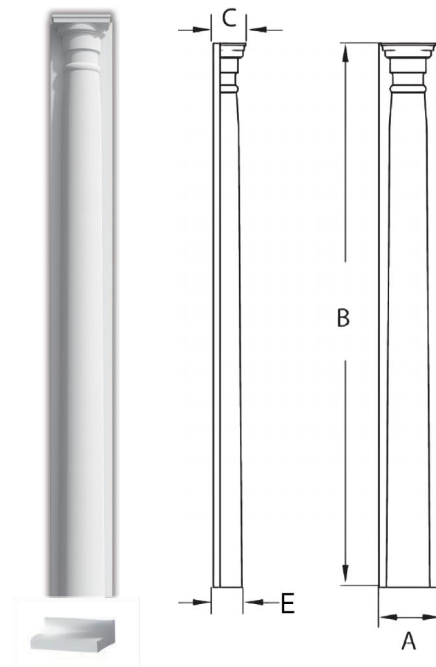

Half-Round Pilaster

Part#	Width(A)	Height (B)	Top Projection (C)	Bottom Projection (E)	Plinth
PL10X96HC	10"(254mm)	80"-93- $\frac{5}{8}$ " (2032-2378mm)	4- $\frac{7}{8}$ "(124mm)	5- $\frac{1}{2}$ "(140mm)	Adjustable

Pilasters are sold as a pair.

PLASTERS

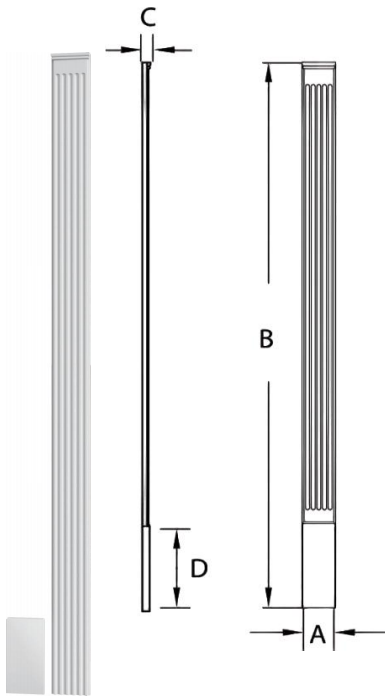

Fluted Narrow Pilaster

Part#	Width(A)	Height(B)	Projection(C)	Plinth Block Height (D)	Plinth
PL5X90E	5- $\frac{1}{4}$ "(133mm)	90"(2286mm)	1- $\frac{1}{2}$ "(32mm)	14- $\frac{1}{4}$ "(362mm)	Molded
PL7X90E	7"(178mm)	90"(2286mm)	1- $\frac{1}{2}$ "(32mm)	14- $\frac{1}{4}$ "(362mm)	Molded
PL9X90E	9"(229mm)	90"(2286mm)	1- $\frac{1}{2}$ "(32mm)	14- $\frac{1}{4}$ "(362mm)	Molded
PL5X120E	5- $\frac{1}{4}$ "(133mm)	120"(3048mm)	1- $\frac{1}{2}$ "(32mm)	14- $\frac{1}{4}$ "(362mm)	Adjustable

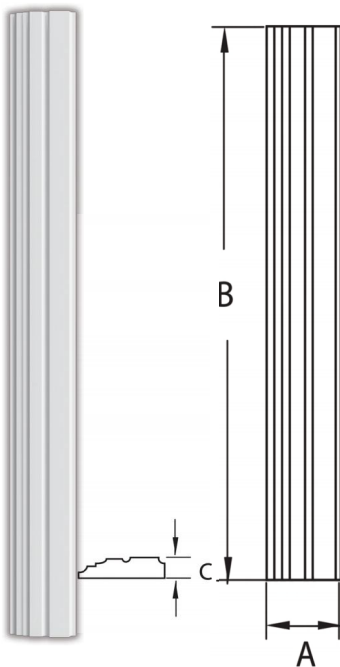

Arch Profile Pilaster

Part#	Width(A)	Height (B)	Projection (C)
PL10X96A	10"(254mm)	96"(2438mm)	2- $\frac{3}{8}$ "(60mm)
PL10X192A	10"(254mm)	192"(4877mm)	2- $\frac{3}{8}$ "(60mm)

Pilasters are sold as a pair.

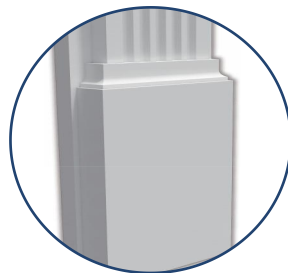

Molded with Plinth

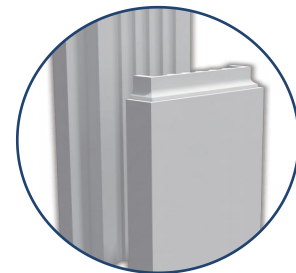

Two-Piece Adjustable

PLASTERS

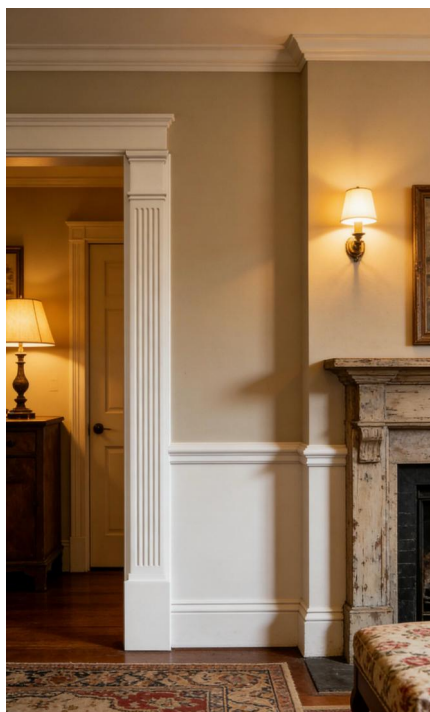
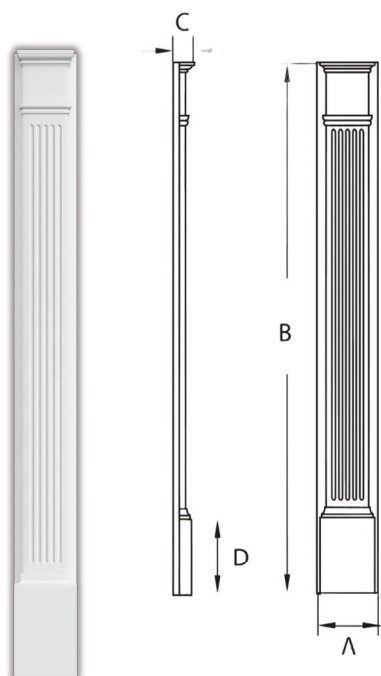

Fluted Plaster

Part#	Width(A)	Height (B)	Projection(C)	Plinth Block Height(D)	Plinth
PL6X90	6- $\frac{1}{4}$ " (159mm)	90" (2286mm)	2- $\frac{1}{2}$ " (64mm)	13- $\frac{1}{4}$ " (337mm)	Molded
PL7X90	7" (178mm)	90" (2286mm)	2- $\frac{1}{2}$ " (64mm)	13- $\frac{1}{4}$ " (337mm)	Molded
PL9X90	9" (229mm)	90" (2286mm)	3" (76mm)	14- $\frac{1}{2}$ " (368mm)	Molded
PL11X90	11" (279mm)	90" (2286mm)	3- $\frac{1}{2}$ " (89mm)	14- $\frac{1}{2}$ " (362mm)	Molded
PL3X108	3- $\frac{1}{2}$ " (89mm)	108" (2743mm)	1- $\frac{5}{8}$ " (41mm)	10" (254mm)	Adjustable
PL4X108	4- $\frac{1}{2}$ " (114mm)	108" (2743mm)	1- $\frac{5}{8}$ " (41mm)	10" (254mm)	Adjustable
PL5X108	5- $\frac{1}{4}$ " (133mm)	108" (2743mm)	1- $\frac{5}{8}$ " (41mm)	10" (254mm)	Adjustable
PL6X108	6- $\frac{1}{4}$ " (159mm)	108" (2743mm)	2- $\frac{1}{2}$ " (64mm)	13- $\frac{1}{4}$ " (337mm)	Adjustable
PL6X144	6- $\frac{1}{4}$ " (159mm)	144" (3658mm)	2- $\frac{1}{2}$ " (64mm)	13- $\frac{1}{4}$ " (337mm)	Adjustable
PL7X102	7" (178mm)	102" (2591mm)	2- $\frac{1}{2}$ " (64mm)	13- $\frac{1}{4}$ " (337mm)	Adjustable
PL7X108	7" (178mm)	108" (2743mm)	2- $\frac{1}{2}$ " (64mm)	13" (330mm)	Adjustable
PL7X144	7" (178mm)	144" (3658mm)	2- $\frac{1}{2}$ " (64mm)	13" (330mm)	Adjustable
PL8X90	8" (203mm)	90" (2286mm)	2- $\frac{1}{2}$ " (64mm)	13" (330mm)	Adjustable
PL8X108	8" (203mm)	108" (2743mm)	2- $\frac{1}{2}$ " (64mm)	13" (330mm)	Adjustable
PL8X144	8" (203mm)	144" (3658mm)	2- $\frac{1}{2}$ " (64mm)	13" (330mm)	Adjustable
PL9X102	9" (229mm)	102" (2591mm)	3" (76mm)	14- $\frac{1}{2}$ " (368mm)	Adjustable
PL9X108	9" (229mm)	108" (2743mm)	3" (76mm)	14- $\frac{1}{2}$ " (368mm)	Adjustable
PL9X144	9" (229mm)	144" (3658mm)	3" (76mm)	14- $\frac{1}{2}$ " (368mm)	Adjustable
PL11X108	11" (279mm)	108" (2743mm)	3- $\frac{1}{2}$ " (89mm)	14- $\frac{1}{2}$ " (368mm)	Adjustable
PL11X120	11" (279mm)	120" (3048mm)	3- $\frac{1}{2}$ " (89mm)	14- $\frac{1}{2}$ " (368mm)	Adjustable
PL11X144	11" (279mm)	144" (3658mm)	3- $\frac{1}{2}$ " (89mm)	14- $\frac{1}{2}$ " (368mm)	Adjustable

Pilasters are sold as a pair.

PLASTERS

Plain Pilaster

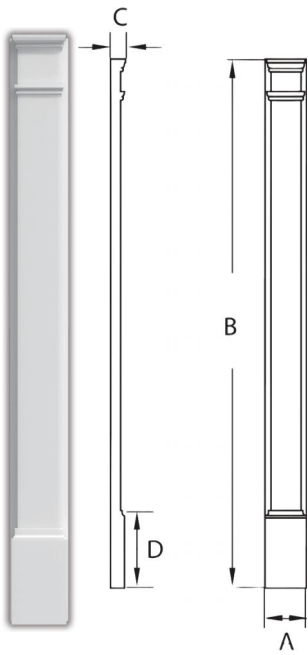

Part#	Width(A)	Height (B)	Projection (C)	Plinth Block Height (D)	Plinth
PL5X90P	5- $\frac{1}{4}$ " (133mm)	90" (2286mm)	1- $\frac{5}{8}$ " (41mm)	10- $\frac{1}{8}$ " (257mm)	Molded
PL6X90P	6" (152mm)	90" (2286mm)	2- $\frac{1}{2}$ " (64mm)	13- $\frac{1}{4}$ " (337mm)	Molded
PL7X90P	7" (178mm)	90" (2286mm)	2- $\frac{1}{2}$ " (64mm)	13- $\frac{1}{4}$ " (337mm)	Molded
PL8X90P	8" (203mm)	90" (2286mm)	2- $\frac{1}{2}$ " (64mm)	13- $\frac{1}{4}$ " (337mm)	Molded
PL9X90P	9" (229mm)	90" (2286mm)	3" (76mm)	14- $\frac{1}{2}$ " (368mm)	Molded
PL5X108P	5- $\frac{1}{4}$ " (133mm)	108" (2743mm)	1- $\frac{5}{8}$ " (41mm)	10" (254mm)	Adjustable
PL6X120P	6" (152mm)	120" (3048mm)	2- $\frac{1}{2}$ " (64mm)	13- $\frac{1}{4}$ " (337mm)	Adjustable
PL7X108P	7" (178mm)	108" (2743mm)	2- $\frac{1}{2}$ " (64mm)	13" (330mm)	Adjustable
PL7X120P	7" (178mm)	120" (3048mm)	2- $\frac{1}{2}$ " (64mm)	13" (330mm)	Adjustable
PL8X108P	8" (203mm)	108" (2743mm)	2- $\frac{5}{8}$ " (67mm)	13" (330mm)	Adjustable
PL9X108P	9" (229mm)	108" (2743mm)	3" (76mm)	14- $\frac{1}{2}$ " (368mm)	Adjustable
PL9X120P	9" (229mm)	120" (3048mm)	3" (76mm)	14- $\frac{1}{2}$ " (368mm)	Adjustable
PL10X120P	10" (254mm)	120" (3048mm)	3- $\frac{1}{4}$ " (83mm)	14- $\frac{1}{2}$ " (368mm)	Adjustable
PL11X90P	11" (279mm)	90" (2286mm)	3- $\frac{1}{2}$ " (89mm)	14- $\frac{1}{2}$ " (368mm)	Adjustable
PL11X96P	11" (279mm)	96" (2438mm)	3- $\frac{1}{2}$ " (89mm)	14- $\frac{1}{2}$ " (368mm)	Adjustable
PL11X108P	11" (279mm)	108" (2743mm)	3- $\frac{1}{2}$ " (89mm)	14- $\frac{1}{2}$ " (368mm)	Adjustable
PL11X120P	11" (279mm)	120" (3048mm)	3- $\frac{1}{2}$ " (89mm)	14- $\frac{1}{2}$ " (368mm)	Adjustable

WINDOWS&DOOR TRIM



Window Trim	Part#	A	B	C	D
	DTST7X69	6- ³ / ₄ " (171mm)	-	68- ⁵ / ₈ " (1743mm)	1- ³ / ₄ " (44mm)
	FP12X96	12" (305mm)	96" (2438mm)	1- ¹ / ₂ " (38mm)	-
	DT44	43- ³ / ₄ " (1111mm)	49- ¹ / ₂ " (1251mm)	33- ¹ / ₄ " (845mm)	4- ¹ / ₂ " (114mm)
	WDP36X18	36" (914mm)	18" (457mm)	-	1- ¹ / ₈ " (29mm)
	DTR457-10	4- ⁵ / ₁₆ " (110mm)	120" (3048mm)	3- ¹ / ₂ " (89mm)	3/ ₄ " (19mm)

WINDOWS&DOOR TRIM

	Part#	Inside Width(A)	Inside Height(B)	Projection(C)	Trim Width(D)
	CF24X4	24- $\frac{1}{8}$ " (616mm)	24- $\frac{1}{8}$ " (616mm)	1" (25mm)	3- $\frac{1}{2}$ " (89mm)
	CF36X4	36- $\frac{1}{8}$ " (918mm)	36- $\frac{1}{8}$ " (918mm)	1" (25mm)	3- $\frac{1}{2}$ " (89mm)

	Part#	Inside Width(A)	Inside Height(B)	Projection(C)	Trim Width(D)
	OVB24X36X4F	24- $\frac{1}{8}$ " (613mm)	36- $\frac{1}{8}$ " (918mm)	1" (25mm)	3" (76mm)
	OVB24X36X4M	24- $\frac{1}{8}$ " (613mm)	36- $\frac{1}{8}$ " (918mm)	1- $\frac{3}{4}$ " (44mm)	3- $\frac{1}{2}$ " (89mm)



WINDOWS&DOOR TRIM

Top Width-A Top Projection-D
Bottom Width-B Bottom Projection-E
Height-C

Keystones	Part#	A	B	C	D	E	Arches&Time
	K6	4- $\frac{3}{4}$ " (121mm)	2- $\frac{3}{4}$ " (70mm)	6- $\frac{1}{2}$ " (165mm)	2- $\frac{1}{4}$ " (57mm)	1- $\frac{5}{8}$ " (41mm)	-
	K8	9- $\frac{3}{4}$ " (248mm)	5- $\frac{3}{4}$ " (146mm)	7- $\frac{3}{4}$ " (197mm)	2- $\frac{1}{4}$ " (57mm)	1- $\frac{1}{4}$ " (32mm)	-
	K10S	8" (203mm)	6" (152mm)	8- $\frac{1}{2}$ " (216mm)	4- $\frac{5}{8}$ " (117mm)	3/4" (19mm)	10"WHSG
	K4F	4- $\frac{1}{4}$ " (108mm)	3" (76mm)	4- $\frac{1}{2}$ " (114mm)	2- $\frac{1}{4}$ " (57mm)	1/2" (13mm)	4F Arches FT152
	K6F	6" (152mm)	4" (102mm)	7" (178mm)	2- $\frac{3}{8}$ " (60mm)	5/8" (16mm)	6F Arches FT159
	K8F	7" (178mm)	5" (127mm)	8- $\frac{7}{8}$ " (225mm)	2- $\frac{1}{2}$ " (64mm)	3/4" (19mm)	FT162
	KP4F	4- $\frac{1}{4}$ " (108mm)	3" (76mm)	4- $\frac{1}{2}$ " (114mm)	2- $\frac{1}{4}$ " (57mm)	1/2" (13mm)	4F Arches FT152
	KP6F	6" (152mm)	4" (102mm)	7" (178mm)	2- $\frac{3}{8}$ " (60mm)	5/8" (16mm)	6F Arches FT159
	K180	2- $\frac{3}{4}$ " (70mm)	2" (51mm)	3- $\frac{1}{8}$ " (79mm)	2- $\frac{1}{2}$ " (64mm)	-	Brick Mould Louvers/Trim MDWM180
	K6M	5- $\frac{3}{4}$ " (146mm)	4" (102mm)	7" (178mm)	3- $\frac{7}{8}$ " (98mm)	1- $\frac{1}{2}$ " (38mm)	6"WH,6"WH w/BT
	K9M	8- $\frac{1}{4}$ " (209mm)	6- $\frac{1}{4}$ " (159mm)	10- $\frac{1}{2}$ " (267mm)	6- $\frac{1}{8}$ " (154mm)	1- $\frac{1}{8}$ " (29mm)	9"WH,9"WH w/BT
	K12M	8- $\frac{1}{2}$ " (216mm)	6" (152mm)	13" (330mm)	5- $\frac{3}{4}$ " (146mm)	2- $\frac{1}{8}$ " (54mm)	12"WH
	KP6M	5- $\frac{3}{4}$ " (146mm)	4" (102mm)	7" (178mm)	4- $\frac{1}{8}$ " (105mm)	1- $\frac{3}{4}$ " (44mm)	6"WH,6"WH w/BT
	KP9M	8" (203mm)	6" (152mm)	11" (279mm)	6- $\frac{1}{4}$ " (159mm)	1- $\frac{5}{8}$ " (41mm)	9"WH,9"WH w/BT
	KP4TM	4- $\frac{1}{4}$ " (108mm)	3" (76mm)	4- $\frac{1}{2}$ " (114mm)	2- $\frac{3}{4}$ " (70mm)	3/4" (19mm)	4M Arch Trim MD215
	KP6TM	6" (152mm)	4" (102mm)	7" (178mm)	2- $\frac{1}{2}$ " (64mm)	7/8" (22mm)	6M Arch Trim MD220 DH221
	K4TM	4- $\frac{1}{4}$ " (108mm)	3" (76mm)	4- $\frac{1}{2}$ " (114mm)	2- $\frac{1}{4}$ " (57mm)	3/4" (19mm)	4M Arch Trim MD215
	K6TM	6" (152mm)	4" (102mm)	7" (178mm)	2- $\frac{1}{2}$ " (64mm)	7/8" (22mm)	6M Arch Trim MD220 DH221
	K10TM	8" (203mm)	5- $\frac{1}{2}$ " (140mm)	11- $\frac{1}{2}$ " (292mm)	4" (102mm)	1- $\frac{3}{4}$ " (44mm)	10M Arch Trim PL10X96A PL10X192A



SHUTTERS

LOUVERED SHUTTERS

With Center Rail

Part#	Width	Height	Projection
LVSTCR12X36	12"(305mm)	36"(914mm)	1"(25mm)
LVSTCR12X48	12"(305mm)	48"(1219mm)	1"(25mm)
LVSTCR16X54	16"(406mm)	54"(1372mm)	1"(25mm)
LVSTCR16X60	16"(406mm)	60"(1524mm)	1"(25mm)
LVSTCR16X72	16"(406mm)	72"(1829mm)	1"(25mm)
LVSTCR18X60	18"(457mm)	60"(1524mm)	1"(25mm)
LVSTCR18X66	18"(457mm)	66"(1676mm)	1"(25mm)
LVSTCR18X72	18"(457mm)	72"(1829mm)	1"(25mm)
LVSTCR24X60	24"(610mm)	60"(1524mm)	1"(25mm)
LVSTCR24X72	24"(610mm)	72"(1829mm)	1"(25mm)



Without Center Rail

Part#	Width	Height	Projection
LVST16X54	16"(406mm)	54"(1372mm)	1"(25mm)
LVST16X72	16"(406mm)	72"(1829mm)	1"(25mm)
LVST18X54	18"(457mm)	54"(1372mm)	1"(25mm)
LVST18X60	18"(457mm)	60"(1524mm)	1"(25mm)
LVST18X72	18"(457mm)	72"(1829mm)	1"(25mm)
LVST24X60	24"(610mm)	60"(1524mm)	1"(25mm)
LVST24X72	24"(610mm)	72"(1829mm)	1"(25mm)



Double Panel

Part#	Width	Height	Projection
STDP16X48	16"(406mm)	48"(1219mm)	1-1/4"(32mm)
STDP16X54	16"(406mm)	54"(1372mm)	1-1/4"(32mm)
STDP16X60	16"(406mm)	60"(1524mm)	1-1/4"(32mm)
STDP16X65	16"(406mm)	65"(1651mm)	1-1/4"(32mm)
STDP16X72	16"(406mm)	72"(1829mm)	1-1/4"(32mm)
STDP18X53	18"(457mm)	53"(1346mm)	1-1/4"(32mm)
STDP18X59	18"(457mm)	59"(1499mm)	1-1/4"(32mm)
STDP18X66	18"(457mm)	66"(1676mm)	1-1/4"(32mm)
STDP18X72	18"(457mm)	72"(1829mm)	1-1/4"(32mm)

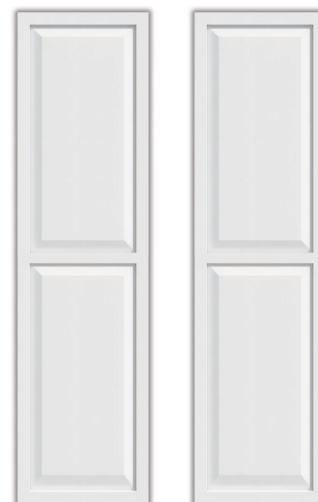

PANEL SHUTTERS



Americraft 5-Board Exterior 2-Equal Panel Framed Board-n-Batten Shutters

Part#	Width	Height	Projection
ST3PB16X53	16"(406mm)	53"(1346mm)	1"(25mm)
ST3PB16X72	16"(406mm)	72"(1829mm)	1"(25mm)

WOODGRAIN SHUTTERS

How to Choose Size & Style

PLATE&BATTEN

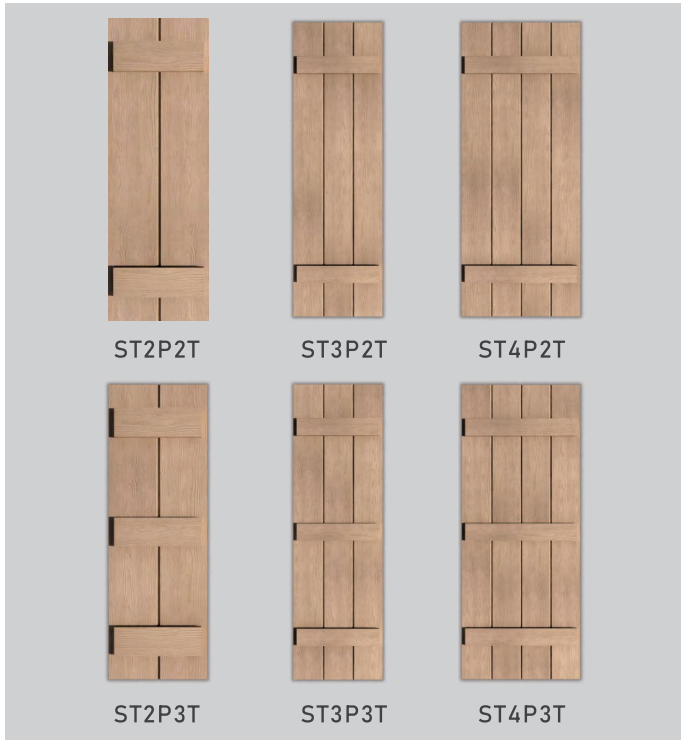

PLATE&BATTEN-END BATTEN



PLATE&BATTEN-QUARTER ROUND



PLATE&BATTEN-ELLIPTICAL (DETAIL IN PAGE 55)



PLATE&BATTEN-Z BATTEN

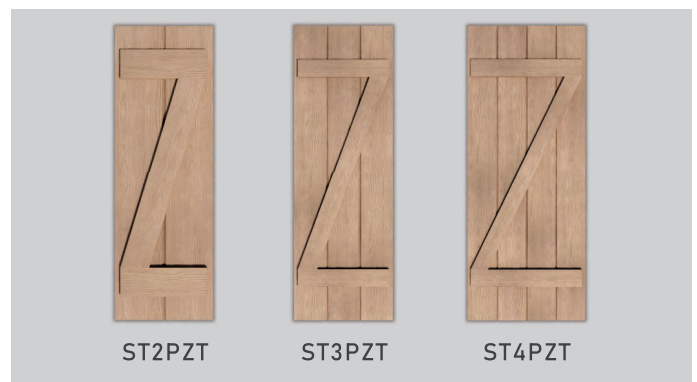

PART NUMBER LOGIC

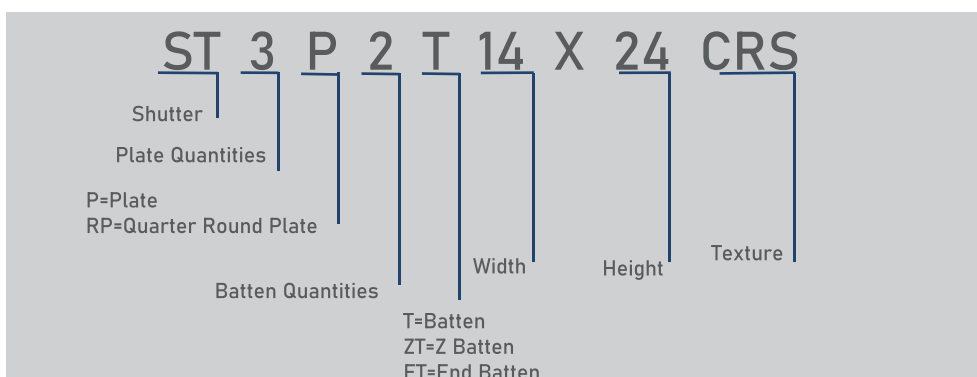

WOODGRAIN SHUTTERS

DIAMOND STYLES WITH SPACED PLATES

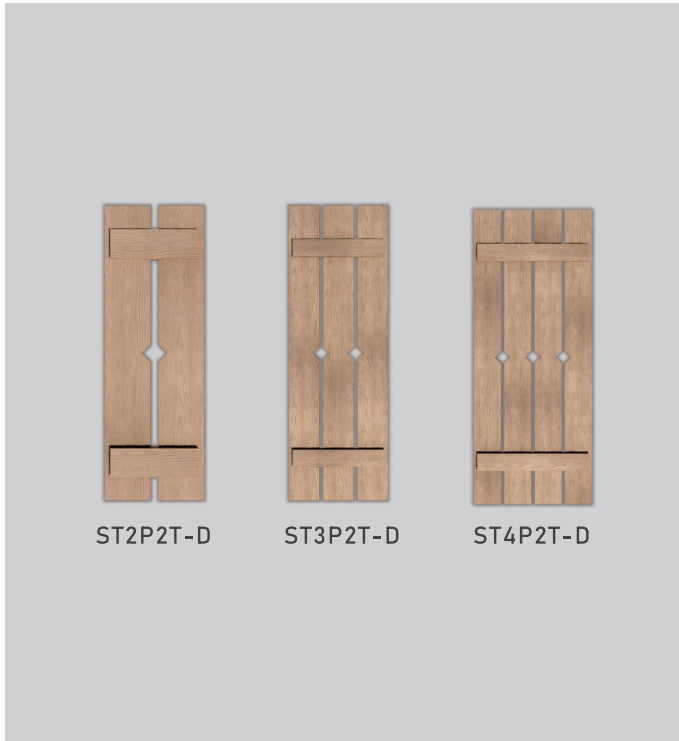

BATTEN STYLES -SPACED PLATES

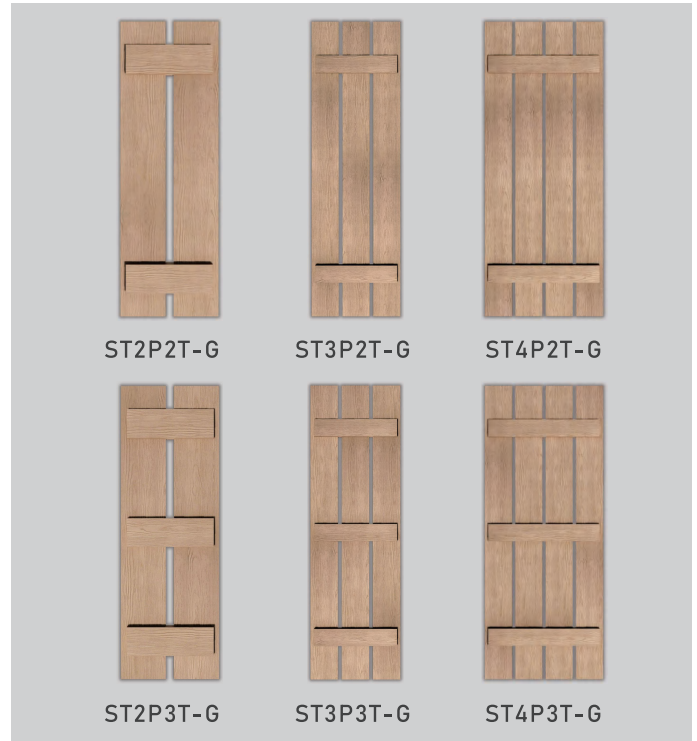

Z-BATTEN STYLES WITH SPACED PLATES



ELLIPTICAL WITH SPACED PLATES (DETAIL IN PAGE 56)



PART NUMBER LOGIC

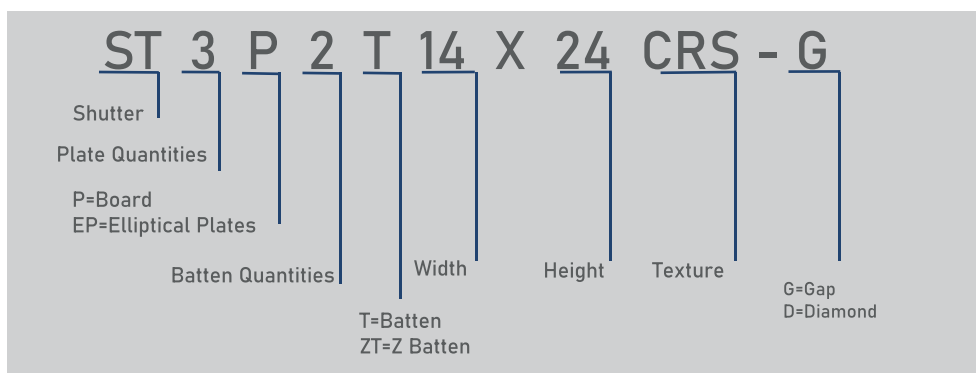

WOODGRAINED SHUTTERS

2-Plate Plank Shutters-2 Batten



Part#	Width	Height	Projection
ST2P2T12X24CRS	12"(305mm)	24"(610mm)	1-½"(38mm)
ST2P2T12X36CRS	12"(305mm)	36"(914mm)	1-½"(38mm)
ST2P2T12X48CRS	12"(305mm)	48"(1219mm)	1-½"(38mm)
ST2P2T12X60CRS	12"(305mm)	60"(1524mm)	1-½"(38mm)
ST2P2T12X72CRS	12"(305mm)	72"(1829mm)	1-½"(38mm)
ST2P2T12X84CRS	12"(305mm)	84"(2134mm)	1-½"(38mm)
ST2P2T12X96CRS	12"(305mm)	96"(2438mm)	1-½"(38mm)
ST2P2T12X108CRS	12"(305mm)	108"(2743mm)	1-½"(38mm)
ST2P2T12X120CRS	12"(305mm)	120"(3048mm)	1-½"(38mm)

2-Plate Plank Shutters-3 Batten



Part#	Width	Height	Projection
ST2P3T12X24CRS	12"(305mm)	24"(610mm)	1-½"(38mm)
ST2P3T12X36CRS	12"(305mm)	36"(914mm)	1-½"(38mm)
ST2P3T12X48CRS	12"(305mm)	48"(1219mm)	1-½"(38mm)
ST2P3T12X60CRS	12"(305mm)	60"(1524mm)	1-½"(38mm)
ST2P3T12X72CRS	12"(305mm)	72"(1829mm)	1-½"(38mm)
ST2P3T12X84CRS	12"(305mm)	84"(2134mm)	1-½"(38mm)
ST2P3T12X96CRS	12"(305mm)	96"(2438mm)	1-½"(38mm)
ST2P3T12X108CRS	12"(305mm)	108"(2743mm)	1-½"(38mm)
ST2P3T12X120CRS	12"(305mm)	120"(3048mm)	1-½"(38mm)

Shutters are sold as a pair.

WOODGRAINED SHUTTERS

3-Plate Plank Shutters-2 Batten

Part#	Width	Height	Projection
ST3P2T14X24CRS	14"(356mm)	24"(610mm)	1-½"(38mm)
ST3P2T14X36CRS	14"(356mm)	36"(914mm)	1-½"(38mm)
ST3P2T14X48CRS	14"(356mm)	48"(1219mm)	1-½"(38mm)
ST3P2T14X60CRS	14"(356mm)	60"(1524mm)	1-½"(38mm)
ST3P2T14X72CRS	14"(356mm)	72"(1829mm)	1-½"(38mm)
ST3P2T14X84CRS	14"(356mm)	84"(2134mm)	1-½"(38mm)
ST3P2T14X96CRS	14"(356mm)	96"(2438mm)	1-½"(38mm)
ST3P2T14X108CRS	14"(356mm)	108"(2743mm)	1-½"(38mm)
ST3P2T14X120CRS	14"(356mm)	120"(3048mm)	1-½"(38mm)
ST3P2T18X24CRS	18"(457mm)	24"(610mm)	1-½"(38mm)
ST3P2T18X36CRS	18"(457mm)	36"(914mm)	1-½"(38mm)
ST3P2T18X48CRS	18"(457mm)	48"(1219mm)	1-½"(38mm)
ST3P2T18X60CRS	18"(457mm)	60"(1524mm)	1-½"(38mm)
ST3P2T18X72CRS	18"(457mm)	72"(1829mm)	1-½"(38mm)
ST3P2T18X84CRS	18"(457mm)	84"(2134mm)	1-½"(38mm)
ST3P2T18X96CRS	18"(457mm)	96"(2438mm)	1-½"(38mm)
ST3P2T18X108CRS	18"(457mm)	108"(2743mm)	1-½"(38mm)
ST3P2T18X120CRS	18"(457mm)	120"(3048mm)	1-½"(38mm)



3-Plate Plank Shutters-3 Batten

Part#	Width	Height	Projection
ST3P3T14X24CRS	14"(356mm)	24"(610mm)	1-½"(38mm)
ST3P3T14X36CRS	14"(356mm)	36"(914mm)	1-½"(38mm)
ST3P3T14X48CRS	14"(356mm)	48"(1219mm)	1-½"(38mm)
ST3P3T14X60CRS	14"(356mm)	60"(1524mm)	1-½"(38mm)
ST3P3T14X72CRS	14"(356mm)	72"(1829mm)	1-½"(38mm)
ST3P3T14X84CRS	14"(356mm)	84"(2134mm)	1-½"(38mm)
ST3P3T14X96CRS	14"(356mm)	96"(2438mm)	1-½"(38mm)
ST3P3T14X108CRS	14"(356mm)	108"(2743mm)	1-½"(38mm)
ST3P3T14X120CRS	14"(356mm)	120"(3048mm)	1-½"(38mm)
ST3P3T18X24CRS	18"(457mm)	24"(610mm)	1-½"(38mm)
ST3P3T18X36CRS	18"(457mm)	36"(914mm)	1-½"(38mm)
ST3P3T18X48CRS	18"(457mm)	48"(1219mm)	1-½"(38mm)
ST3P3T18X60CRS	18"(457mm)	60"(1524mm)	1-½"(38mm)
ST3P3T18X72CRS	18"(457mm)	72"(1829mm)	1-½"(38mm)
ST3P3T18X84CRS	18"(457mm)	84"(2134mm)	1-½"(38mm)
ST3P3T18X96CRS	18"(457mm)	96"(2438mm)	1-½"(38mm)
ST3P3T18X108CRS	18"(457mm)	108"(2743mm)	1-½"(38mm)
ST3P3T18X120CRS	18"(457mm)	120"(3048mm)	1-½"(38mm)





WOODGRAINED SHUTTERS

4-Plate Plank Shutters-2 Batten

Part#	Width	Height	Projection
ST4P2T24X24CRS	24"(610mm)	24"(610mm)	1-½"(38mm)
ST4P2T24X36CRS	24"(610mm)	36"(914mm)	1-½"(38mm)
ST4P2T24X48CRS	24"(610mm)	48"(1219mm)	1-½"(38mm)
ST4P2T24X60CRS	24"(610mm)	60"(1524mm)	1-½"(38mm)
ST4P2T24X72CRS	24"(610mm)	72"(1829mm)	1-½"(38mm)
ST4P2T24X84CRS	24"(610mm)	84"(2134mm)	1-½"(38mm)
ST4P2T24X96CRS	24"(610mm)	96"(2438mm)	1-½"(38mm)
ST4P2T24X108CRS	24"(610mm)	108"(2743mm)	1-½"(38mm)
ST4P2T24X120CRS	24"(610mm)	120"(3048mm)	1-½"(38mm)



4-Plate Plank Shutters-2 Batten

Part#	Width	Height	Projection
ST4P3T24X24CRS	24"(610mm)	24"(610mm)	1-½"(38mm)
ST4P3T24X36CRS	24"(610mm)	36"(914mm)	1-½"(38mm)
ST4P3T24X48CRS	24"(610mm)	48"(1219mm)	1-½"(38mm)
ST4P3T24X60CRS	24"(610mm)	60"(1524mm)	1-½"(38mm)
ST4P3T24X72CRS	24"(610mm)	72"(1829mm)	1-½"(38mm)
ST4P3T24X84CRS	24"(610mm)	84"(2134mm)	1-½"(38mm)
ST4P3T24X96CRS	24"(610mm)	96"(2438mm)	1-½"(38mm)
ST4P3T24X108CRS	24"(610mm)	108"(2743mm)	1-½"(38mm)
ST4P3T24X120CRS	24"(610mm)	120"(3048mm)	1-½"(38mm)

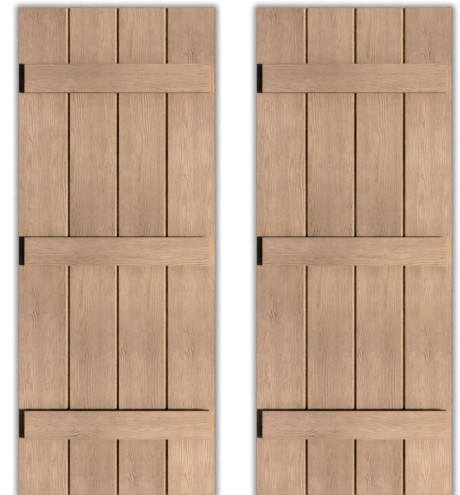

Shutters are sold as a pair.

WOODGRAINED SHUTTERS



2-Plate Plank Shutters - 2-Batten

Part#	Width	Height	Projection
ST2P2T12X24CRS-G	12"(305mm)	24"(610mm)	1-½"(38mm)
ST2P2T12X36CRS-G	12"(305mm)	36"(914mm)	1-½"(38mm)
ST2P2T12X48CRS-G	12"(305mm)	48"(1219mm)	1-½"(38mm)
ST2P2T12X60CRS-G	12"(305mm)	60"(1524mm)	1-½"(38mm)
ST2P2T12X72CRS-G	12"(305mm)	72"(1829mm)	1-½"(38mm)
ST2P2T12X84CRS-G	12"(305mm)	84"(2134mm)	1-½"(38mm)
ST2P2T12X96CRS-G	12"(305mm)	96"(2438mm)	1-½"(38mm)
ST2P2T12X108CRS-G	12"(305mm)	108"(2743mm)	1-½"(38mm)
ST2P2T12X120CRS-G	12"(305mm)	120"(3048mm)	1-½"(38mm)



2-Plate Plank Shutters - 3-Batten

Part#	Width	Height	Projection
ST2P3T12X24CRS-G	12"(305mm)	24"(610mm)	1-½"(38mm)
ST2P3T12X36CRS-G	12"(305mm)	36"(914mm)	1-½"(38mm)
ST2P3T12X48CRS-G	12"(305mm)	48"(1219mm)	1-½"(38mm)
ST2P3T12X60CRS-G	12"(305mm)	60"(1524mm)	1-½"(38mm)
ST2P3T12X72CRS-G	12"(305mm)	72"(1829mm)	1-½"(38mm)
ST2P3T12X84CRS-G	12"(305mm)	84"(2134mm)	1-½"(38mm)
ST2P3T12X96CRS-G	12"(305mm)	96"(2438mm)	1-½"(38mm)
ST2P3T12X108CRS-G	12"(305mm)	108"(2743mm)	1-½"(38mm)
ST2P3T12X120CRS-G	12"(305mm)	120"(3048mm)	1-½"(38mm)

WOODGRAINED SHUTTERS

3-Plate Plank Shutters - 2-Batten

Part#	Width	Height	Projection
ST3P2T18X24CRS-G	18"(457mm)	24"(610mm)	1-½"(38mm)
ST3P2T18X36CRS-G	18"(457mm)	36"(914mm)	1-½"(38mm)
ST3P2T18X48CRS-G	18"(457mm)	48"(1219mm)	1-½"(38mm)
ST3P2T18X60CRS-G	18"(457mm)	60"(1524mm)	1-½"(38mm)
ST3P2T18X72CRS-G	18"(457mm)	72"(1829mm)	1-½"(38mm)
ST3P2T18X84CRS-G	18"(457mm)	84"(2134mm)	1-½"(38mm)
ST3P2T18X96CRS-G	18"(457mm)	96"(2438mm)	1-½"(38mm)
ST3P2T18X108CRS-G	18"(457mm)	108"(2743mm)	1-½"(38mm)
ST3P2T18X120CRS-G	18"(457mm)	120"(3048mm)	1-½"(38mm)



3-Plate Plank Shutters - 3-Batten

Part#	Width	Height	Projection
ST3P3T18X24CRS-G	18"(457mm)	24"(610mm)	1-½"(38mm)
ST3P3T18X36CRS-G	18"(457mm)	36"(914mm)	1-½"(38mm)
ST3P3T18X48CRS-G	18"(457mm)	48"(1219mm)	1-½"(38mm)
ST3P3T18X60CRS-G	18"(457mm)	60"(1524mm)	1-½"(38mm)
ST3P3T18X72CRS-G	18"(457mm)	72"(1829mm)	1-½"(38mm)
ST3P3T18X84CRS-G	18"(457mm)	84"(2134mm)	1-½"(38mm)
ST3P3T18X96CRS-G	18"(457mm)	96"(2438mm)	1-½"(38mm)
ST3P3T18X108CRS-G	18"(457mm)	108"(2743mm)	1-½"(38mm)
ST3P3T18X120CRS-G	18"(457mm)	120"(3048mm)	1-½"(38mm)



WOODGRAINED SHUTTERS

4-Plate Plank Shutters - 2-Batten

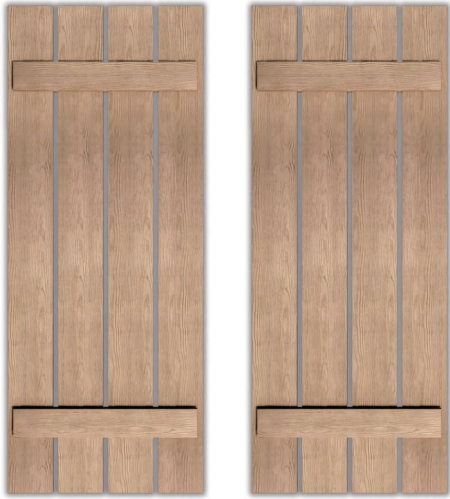

Part#	Width	Height	Projection
ST4P2T24X24CRS-G	24"(610mm)	24"(610mm)	1-½"(38mm)
ST4P2T24X36CRS-G	24"(610mm)	36"(914mm)	1-½"(38mm)
ST4P2T24X48CRS-G	24"(610mm)	48"(1219mm)	1-½"(38mm)
ST4P2T24X60CRS-G	24"(610mm)	60"(1524mm)	1-½"(38mm)
ST4P2T24X72CRS-G	24"(610mm)	72"(1829mm)	1-½"(38mm)
ST4P2T24X84CRS-G	24"(610mm)	84"(2134mm)	1-½"(38mm)
ST4P2T24X96CRS-G	24"(610mm)	96"(2438mm)	1-½"(38mm)
ST4P2T24X108CRS-G	24"(610mm)	108"(2743mm)	1-½"(38mm)
ST4P2T24X120CRS-G	24"(610mm)	120"(3048mm)	1-½"(38mm)

4-Plate Plank Shutters - 3-Batten

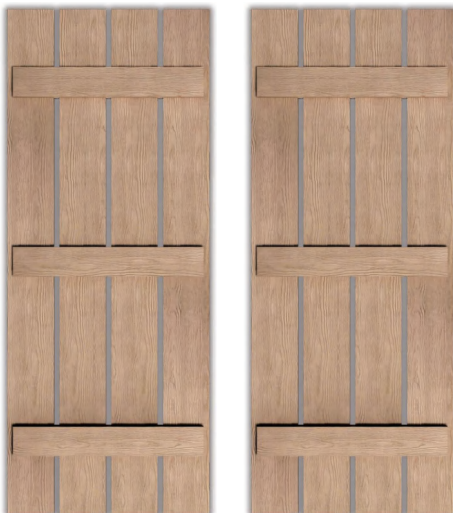

Part#	Width	Height	Projection
ST4P3T24X24CRS-G	24"(610mm)	24"(610mm)	1-½"(38mm)
ST4P3T24X36CRS-G	24"(610mm)	36"(914mm)	1-½"(38mm)
ST4P3T24X48CRS-G	24"(610mm)	48"(1219mm)	1-½"(38mm)
ST4P3T24X60CRS-G	24"(610mm)	60"(1524mm)	1-½"(38mm)
ST4P3T24X72CRS-G	24"(610mm)	72"(1829mm)	1-½"(38mm)
ST4P3T24X84CRS-G	24"(610mm)	84"(2134mm)	1-½"(38mm)
ST4P3T24X96CRS-G	24"(610mm)	96"(2438mm)	1-½"(38mm)
ST4P3T24X108CRS-G	24"(610mm)	108"(2743mm)	1-½"(38mm)
ST4P3T24X120CRS-G	24"(610mm)	120"(3048mm)	1-½"(38mm)

Shutters are sold as a pair.

WOODGRAINED SHUTTERS

2-Plate Plank Shutters - Diamond

Part#	Width	Height	Projection
ST2P2T12X24CRS-D	12"(305mm)	24"(610mm)	1-½"(38mm)
ST2P2T12X36CRS-D	12"(305mm)	36"(914mm)	1-½"(38mm)
ST2P2T12X48CRS-D	12"(305mm)	48"(1219mm)	1-½"(38mm)
ST2P2T12X60CRS-D	12"(305mm)	60"(1524mm)	1-½"(38mm)
ST2P2T12X72CRS-D	12"(305mm)	72"(1829mm)	1-½"(38mm)
ST2P2T12X84CRS-D	12"(305mm)	84"(2134mm)	1-½"(38mm)
ST2P2T12X96CRS-D	12"(305mm)	96"(2438mm)	1-½"(38mm)
ST2P2T12X108CRS-D	12"(305mm)	108"(2743mm)	1-½"(38mm)
ST2P2T12X120CRS-D	12"(305mm)	120"(3048mm)	1-½"(38mm)



3-Plate Plank Shutters - Diamond

Part#	Width	Height	Projection
ST3P2T18X24CRS-D	18"(457mm)	24"(610mm)	1-½"(38mm)
ST3P2T18X36CRS-D	18"(457mm)	36"(914mm)	1-½"(38mm)
ST3P2T18X48CRS-D	18"(457mm)	48"(1219mm)	1-½"(38mm)
ST3P2T18X60CRS-D	18"(457mm)	60"(1524mm)	1-½"(38mm)
ST3P2T18X72CRS-D	18"(457mm)	72"(1829mm)	1-½"(38mm)
ST3P2T18X84CRS-D	18"(457mm)	84"(2134mm)	1-½"(38mm)
ST3P2T18X96CRS-D	18"(457mm)	96"(2438mm)	1-½"(38mm)
ST3P2T18X108CRS-D	18"(457mm)	108"(2743mm)	1-½"(38mm)
ST3P2T18X120CRS-D	18"(457mm)	120"(3048mm)	1-½"(38mm)

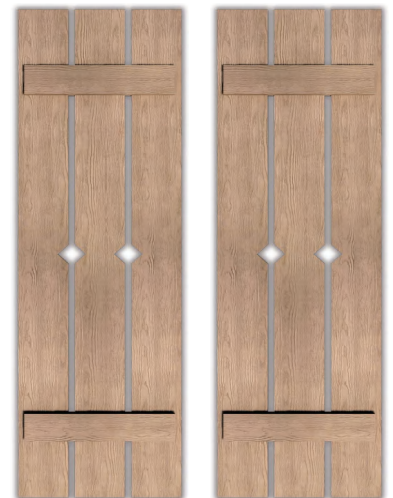

4-Plate Plank Shutters - Diamond

Part#	Width	Height	Projection
ST4P2T24X24CRS-D	24"(610mm)	24"(610mm)	1-½"(38mm)
ST4P2T24X36CRS-D	24"(610mm)	36"(914mm)	1-½"(38mm)
ST4P2T24X48CRS-D	24"(610mm)	48"(1219mm)	1-½"(38mm)
ST4P2T24X60CRS-D	24"(610mm)	60"(1524mm)	1-½"(38mm)
ST4P2T24X72CRS-D	24"(610mm)	72"(1829mm)	1-½"(38mm)
ST4P2T24X84CRS-D	24"(610mm)	84"(2134mm)	1-½"(38mm)
ST4P2T24X96CRS-D	24"(610mm)	96"(2438mm)	1-½"(38mm)
ST4P2T24X108CRS-D	24"(610mm)	108"(2743mm)	1-½"(38mm)
ST4P2T24X120CRS-D	24"(610mm)	120"(3048mm)	1-½"(38mm)

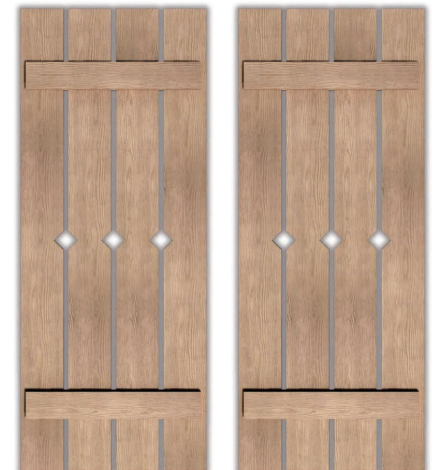

Shutters are sold as a pair.

WOODGRAINED SHUTTERS

2-Plate & Batten Shutters - Z-Batten

Part#	Width	Height	Projection
ST2PZT12X24CRS	12"(305mm)	24"(610mm)	1-½"(38mm)
ST2PZT12X36CRS	12"(305mm)	36"(914mm)	1-½"(38mm)
ST2PZT12X48CRS	12"(305mm)	48"(1219mm)	1-½"(38mm)
ST2PZT12X60CRS	12"(305mm)	60"(1524mm)	1-½"(38mm)
ST2PZT12X72CRS	12"(305mm)	72"(1829mm)	1-½"(38mm)
ST2PZT12X84CRS	12"(305mm)	84"(2134mm)	1-½"(38mm)
ST2PZT12X96CRS	12"(305mm)	96"(2438mm)	1-½"(38mm)
ST2PZT12X108CRS	12"(305mm)	108"(2743mm)	1-½"(38mm)
ST2PZT12X120CRS	12"(305mm)	120"(3048mm)	1-½"(38mm)



WOODGRAINED SHUTTERS

3-Plate & Batten Shutters - Z-Batten



Part#	Width	Height	Projection
ST3PZT14X24CRS	14"(356mm)	24"(610mm)	1-½"(38mm)
ST3PZT14X36CRS	14"(356mm)	36"(914mm)	1-½"(38mm)
ST3PZT14X48CRS	14"(356mm)	48"(1219mm)	1-½"(38mm)
ST3PZT14X60CRS	14"(356mm)	60"(1524mm)	1-½"(38mm)
ST3PZT14X72CRS	14"(356mm)	72"(1829mm)	1-½"(38mm)
ST3PZT14X84CRS	14"(356mm)	84"(2134mm)	1-½"(38mm)
ST3PZT14X96CRS	14"(356mm)	96"(2438mm)	1-½"(38mm)
ST3PZT14X108CRS	14"(356mm)	108"(2743mm)	1-½"(38mm)
ST3PZT14X120CRS	14"(356mm)	120"(3048mm)	1-½"(38mm)
ST3PZT18X24CRS	18"(457mm)	24"(610mm)	1-½"(38mm)
ST3PZT18X36CRS	18"(457mm)	36"(914mm)	1-½"(38mm)
ST3PZT18X48CRS	18"(457mm)	48"(1219mm)	1-½"(38mm)
ST3PZT18X60CRS	18"(457mm)	60"(1524mm)	1-½"(38mm)
ST3PZT18X72CRS	18"(457mm)	72"(1829mm)	1-½"(38mm)
ST3PZT18X84CRS	18"(457mm)	84"(2134mm)	1-½"(38mm)
ST3PZT18X96CRS	18"(457mm)	96"(2438mm)	1-½"(38mm)
ST3PZT18X108CRS	18"(457mm)	108"(2743mm)	1-½"(38mm)
ST3PZT18X120CRS	18"(457mm)	120"(3048mm)	1-½"(38mm)

Shutters are sold as a pair.

WOODGRAINED SHUTTERS

4-Plate & Batten Shutters - Z-Batten

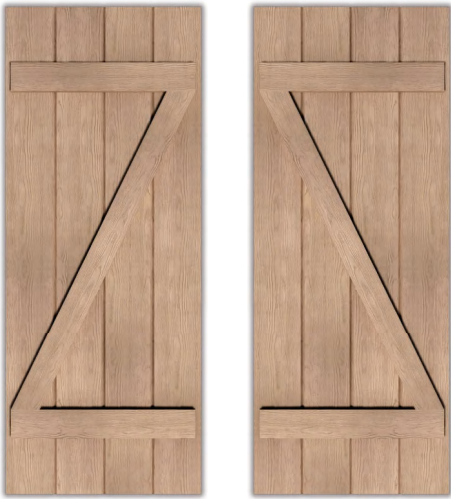

Part#	Width	Height	Projection
ST4PZT24X24CRS	24"(610mm)	24"(610mm)	1-½"(38mm)
ST4PZT24X36CRS	24"(610mm)	36"(914mm)	1-½"(38mm)
ST4PZT24X48CRS	24"(610mm)	48"(1219mm)	1-½"(38mm)
ST4PZT24X60CRS	24"(610mm)	60"(1524mm)	1-½"(38mm)
ST4PZT24X72CRS	24"(610mm)	72"(1829mm)	1-½"(38mm)
ST4PZT24X84CRS	24"(610mm)	84"(2134mm)	1-½"(38mm)
ST4PZT24X96CRS	24"(610mm)	96"(2438mm)	1-½"(38mm)
ST4PZT24X108CRS	24"(610mm)	108"(2743mm)	1-½"(38mm)
ST4PZT24X120CRS	24"(610mm)	120"(3048mm)	1-½"(38mm)

Shutters are sold as a pair.



WOODGRAINED SHUTTERS

2-Plate Plank Shutters - Z-Batten



Part#	Width	Height	Projection
ST2PZT12X24CRS-G	12"(305mm)	24"(610mm)	1-½"(38mm)
ST2PZT12X36CRS-G	12"(305mm)	36"(914mm)	1-½"(38mm)
ST2PZT12X48CRS-G	12"(305mm)	48"(1219mm)	1-½"(38mm)
ST2PZT12X60CRS-G	12"(305mm)	60"(1524mm)	1-½"(38mm)
ST2PZT12X72CRS-G	12"(305mm)	72"(1829mm)	1-½"(38mm)
ST2PZT12X84CRS-G	12"(305mm)	84"(2134mm)	1-½"(38mm)
ST2PZT12X96CRS-G	12"(305mm)	96"(2438mm)	1-½"(38mm)
ST2PZT12X108CRS-G	12"(305mm)	108"(2743mm)	1-½"(38mm)
ST2PZT12X120CRS-G	12"(305mm)	120"(3048mm)	1-½"(38mm)

3-Plate Plank Shutters - Z-Batten



Part#	Width	Height	Projection
ST3PZT18X24CRS-G	18"(457mm)	24"(610mm)	1-½"(38mm)
ST3PZT18X36CRS-G	18"(457mm)	36"(914mm)	1-½"(38mm)
ST3PZT18X48CRS-G	18"(457mm)	48"(1219mm)	1-½"(38mm)
ST3PZT18X60CRS-G	18"(457mm)	60"(1524mm)	1-½"(38mm)
ST3PZT18X72CRS-G	18"(457mm)	72"(1829mm)	1-½"(38mm)
ST3PZT18X84CRS-G	18"(457mm)	84"(2134mm)	1-½"(38mm)
ST3PZT18X96CRS-G	18"(457mm)	96"(2438mm)	1-½"(38mm)
ST3PZT18X108CRS-G	18"(457mm)	108"(2743mm)	1-½"(38mm)
ST3PZT18X120CRS-G	18"(457mm)	120"(3048mm)	1-½"(38mm)

4-Plate Plank Shutters - Z-Batten

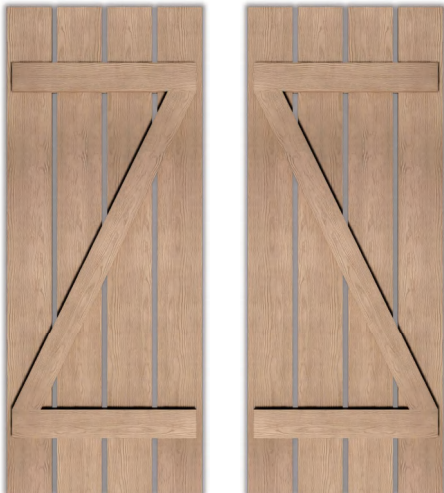

Part#	Width	Height	Projection
ST4PZT24X24CRS-G	24"(610mm)	24"(610mm)	1-½"(38mm)
ST4PZT24X36CRS-G	24"(610mm)	36"(914mm)	1-½"(38mm)
ST4PZT24X48CRS-G	24"(610mm)	48"(1219mm)	1-½"(38mm)
ST4PZT24X60CRS-G	24"(610mm)	60"(1524mm)	1-½"(38mm)
ST4PZT24X72CRS-G	24"(610mm)	72"(1829mm)	1-½"(38mm)
ST4PZT24X84CRS-G	24"(610mm)	84"(2134mm)	1-½"(38mm)
ST4PZT24X96CRS-G	24"(610mm)	96"(2438mm)	1-½"(38mm)
ST4PZT24X108CRS-G	24"(610mm)	108"(2743mm)	1-½"(38mm)
ST4PZT24X120CRS-G	24"(610mm)	120"(3048mm)	1-½"(38mm)

WOODGRAINED SHUTTERS



2-Plate & Batten Shutters - Quarter Round

Part#	Width	Height	Projection
ST2RP2T12X24CRS	12"(305mm)	24"(610mm)	1-½"(38mm)
ST2RP2T12X36CRS	12"(305mm)	36"(914mm)	1-½"(38mm)
ST2RP2T12X48CRS	12"(305mm)	48"(1219mm)	1-½"(38mm)
ST2RP2T12X60CRS	12"(305mm)	60"(1524mm)	1-½"(38mm)
ST2RP2T12X72CRS	12"(305mm)	72"(1829mm)	1-½"(38mm)
ST2RP2T12X84CRS	12"(305mm)	84"(2134mm)	1-½"(38mm)
ST2RP2T12X96CRS	12"(305mm)	96"(2438mm)	1-½"(38mm)
ST2RP2T12X108CRS	12"(305mm)	108"(2743mm)	1-½"(38mm)
ST2RP2T12X120CRS	12"(305mm)	120"(3048mm)	1-½"(38mm)

3-Plate & Batten Shutters - Quarter Round



Part#	Width	Height	Projection
ST3RP2T14X36CRS	14"(356mm)	36"(914mm)	1-½"(38mm)
ST3RP2T14X48CRS	14"(356mm)	48"(1219mm)	1-½"(38mm)
ST3RP2T14X60CRS	14"(356mm)	60"(1524mm)	1-½"(38mm)
ST3RP2T14X72CRS	14"(356mm)	72"(1829mm)	1-½"(38mm)
ST3RP2T14X84CRS	14"(356mm)	84"(2134mm)	1-½"(38mm)
ST3RP2T14X96CRS	14"(356mm)	96"(2438mm)	1-½"(38mm)
ST3RP2T14X108CRS	14"(356mm)	108"(2743mm)	1-½"(38mm)
ST3RP2T14X120CRS	14"(356mm)	120"(3048mm)	1-½"(38mm)
ST3RP2T18X36CRS	18"(457mm)	36"(914mm)	1-½"(38mm)
ST3RP2T18X48CRS	18"(457mm)	48"(1219mm)	1-½"(38mm)
ST3RP2T18X60CRS	18"(457mm)	60"(1524mm)	1-½"(38mm)
ST3RP2T18X69CRS	18"(457mm)	69"(1753mm)	1-½"(38mm)
ST3RP2T18X72CRS	18"(457mm)	72"(1829mm)	1-½"(38mm)
ST3RP2T18X84CRS	18"(457mm)	84"(2134mm)	1-½"(38mm)
ST3RP2T18X96CRS	18"(457mm)	96"(2438mm)	1-½"(38mm)
ST3RP2T18X108CRS	18"(457mm)	108"(2743mm)	1-½"(38mm)
ST3RP2T18X120CRS	18"(457mm)	120"(3048mm)	1-½"(38mm)

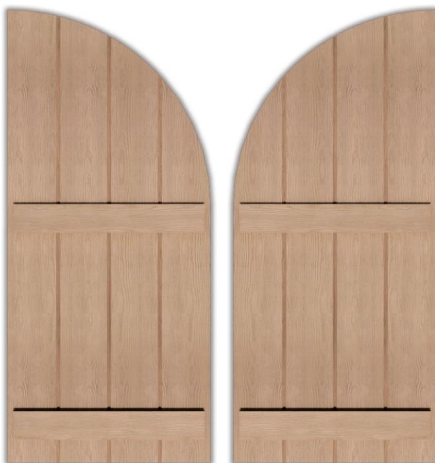

4-Plate & Batten Shutters - Quarter Round

Part#	Width	Height	Projection
ST4RP2T24X48CRS	24"(610mm)	48"(1219mm)	1-½"(38mm)
ST4RP2T24X60CRS	24"(610mm)	60"(1524mm)	1-½"(38mm)
ST4RP2T24X72CRS	24"(610mm)	72"(1829mm)	1-½"(38mm)
ST4RP2T24X84CRS	24"(610mm)	84"(2134mm)	1-½"(38mm)
ST4RP2T24X96CRS	24"(610mm)	96"(2438mm)	1-½"(38mm)
ST4RP2T24X108CRS	24"(610mm)	108"(2743mm)	1-½"(38mm)
ST4RP2T24X120CRS	24"(610mm)	120"(3048mm)	1-½"(38mm)

Shutters are sold as a pair.

WOODGRAINED SHUTTERS

2-Plate & Batten Shutters - End Batten

Part#	Width	Height	Projection
ST2P2ET12X24CRS	12"(305mm)	24"(610mm)	1-½"(38mm)
ST2P2ET12X36CRS	12"(305mm)	36"(914mm)	1-½"(38mm)
ST2P2ET12X48CRS	12"(305mm)	48"(1219mm)	1-½"(38mm)
ST2P2ET12X60CRS	12"(305mm)	60"(1524mm)	1-½"(38mm)
ST2P2ET12X72CRS	12"(305mm)	72"(1829mm)	1-½"(38mm)
ST2P2ET12X84CRS	12"(305mm)	84"(2134mm)	1-½"(38mm)
ST2P2ET12X96CRS	12"(305mm)	96"(2438mm)	1-½"(38mm)
ST2P2ET12X108CRS	12"(305mm)	108"(2743mm)	1-½"(38mm)
ST2P2ET12X120CRS	12"(305mm)	120"(3048mm)	1-½"(38mm)



3-Plate & Batten Shutters - End Batten

Part#	Width	Height	Projection
ST3P2ET14X24CRS	14"(356mm)	24"(610mm)	1-½"(38mm)
ST3P2ET14X36CRS	14"(356mm)	36"(914mm)	1-½"(38mm)
ST3P2ET14X48CRS	14"(356mm)	48"(1219mm)	1-½"(38mm)
ST3P2ET14X60CRS	14"(356mm)	60"(1524mm)	1-½"(38mm)
ST3P2ET14X72CRS	14"(356mm)	72"(1829mm)	1-½"(38mm)
ST3P2ET14X84CRS	14"(356mm)	84"(2134mm)	1-½"(38mm)
ST3P2ET14X96CRS	14"(356mm)	96"(2438mm)	1-½"(38mm)
ST3P2ET14X108CRS	14"(356mm)	108"(2743mm)	1-½"(38mm)
ST3P2ET14X120CRS	14"(356mm)	120"(3048mm)	1-½"(38mm)
ST3P2ET18X24CRS	18"(457mm)	24"(610mm)	1-½"(38mm)
ST3P2ET18X36CRS	18"(457mm)	36"(914mm)	1-½"(38mm)
ST3P2ET18X48CRS	18"(457mm)	48"(1219mm)	1-½"(38mm)
ST3P2ET18X60CRS	18"(457mm)	60"(1524mm)	1-½"(38mm)
ST3P2ET18X72CRS	18"(457mm)	72"(1829mm)	1-½"(38mm)
ST3P2ET18X84CRS	18"(457mm)	84"(2134mm)	1-½"(38mm)
ST3P2ET18X96CRS	18"(457mm)	96"(2438mm)	1-½"(38mm)
ST3P2ET18X108CRS	18"(457mm)	108"(2743mm)	1-½"(38mm)
ST3P2ET18X120CRS	18"(457mm)	120"(3048mm)	1-½"(38mm)

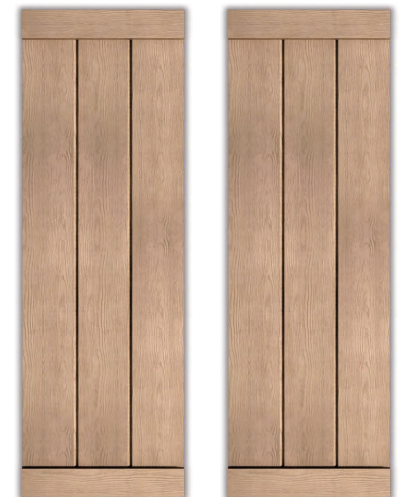

WOODGRAINED SHUTTERS

4-Plate & Batten Shutters - End Batten

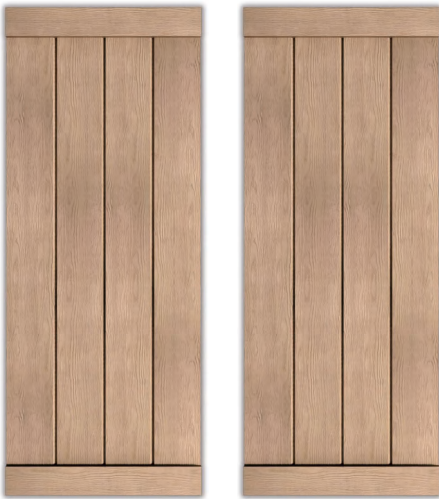

Part#	Width	Height	Projection
ST4P2ET24X24CRS	24"(610mm)	24"(610mm)	1-½"(38mm)
ST4P2ET24X36CRS	24"(610mm)	36"(914mm)	1-½"(38mm)
ST4P2ET24X48CRS	24"(610mm)	48"(1219mm)	1-½"(38mm)
ST4P2ET24X60CRS	24"(610mm)	60"(1524mm)	1-½"(38mm)
ST4P2ET24X72CRS	24"(610mm)	72"(1829mm)	1-½"(38mm)
ST4P2ET24X84CRS	24"(610mm)	84"(2134mm)	1-½"(38mm)
ST4P2ET24X96CRS	24"(610mm)	96"(2438mm)	1-½"(38mm)
ST4P2ET24X108CRS	24"(610mm)	108"(2743mm)	1-½"(38mm)
ST4P2ET24X120CRS	24"(610mm)	120"(3048mm)	1-½"(38mm)

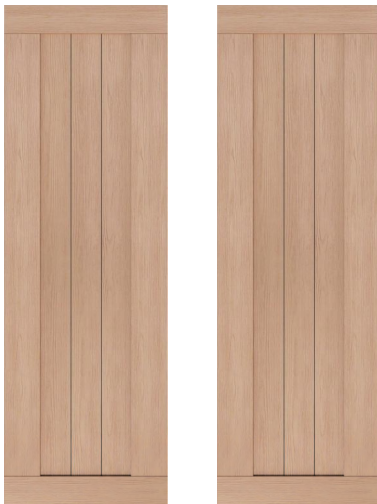

Woodgrain Panel Shutter with Border

Part#	Width	Height	Projection
ST3PB15X46CRS	15"(381mm)	46"(1168mm)	1"(25mm)
ST3PB18X40CRS	18"(457mm)	40"(1016mm)	1"(25mm)
ST3PB18X66CRS	18"(457mm)	66"(1676mm)	1"(25mm)
ST3PB24X54CRS	24"(610mm)	54"(1372mm)	1"(25mm)



Woodgrain Louvered Shutter with Center Rail-OAK

Part#	Width	Height	Projection
LVSTCR12X48KS	12"(305mm)	48"(1219mm)	1"(25mm)
LVSTCR16X48KS	16"(406mm)	48"(1219mm)	1"(25mm)
LVSTCR16X60KS	16"(406mm)	60"(1524mm)	1"(25mm)
LVSTCR16X65KS	16"(406mm)	65"(1651mm)	1"(25mm)
LVSTCR18X48KS	18"(457mm)	48"(1219mm)	1"(25mm)
LVSTCR18X60KS	18"(457mm)	60"(1524mm)	1"(25mm)

Shutters are sold as a pair.

WOODGRAIN SHUTTERS

Woodgrain Louvered Shutter with Brown-OAK

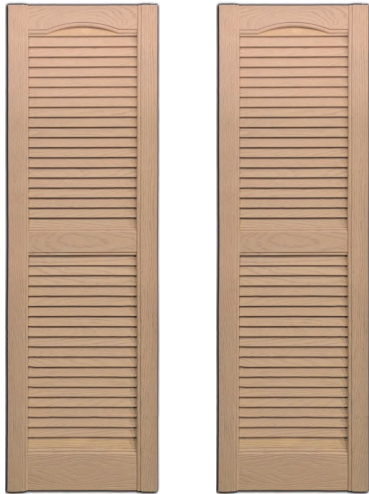

Part#	Width	Height	Projection
LVSTCR12X39KS-C	12"(305mm)	39"(991mm)	1"(25mm)
LVSTCR12X46KS-C	12"(305mm)	46"(1168mm)	1"(25mm)
LVSTCR12X60KS-C	12"(305mm)	60"(1524mm)	1"(25mm)
LVSTCR14.5X39KS	14-½"(368mm)	39"(991mm)	1"(25mm)
LVSTCR14.5X46KS	14-½"(368mm)	46"(1168mm)	1"(25mm)
LVSTCR14.5X47KS	14-½"(368mm)	47"(1194mm)	1"(25mm)
LVSTCR14.5X48KS	14-½"(368mm)	48"(1219mm)	1"(25mm)
LVSTCR14.5X59KS-C	14-½"(368mm)	59"(1499mm)	1"(25mm)
LVSTCR14.5X60KS-C	14-½"(368mm)	60"(1524mm)	1"(25mm)
LVSTCR14.5X80KS-C	14-½"(368mm)	80"(2032mm)	1"(25mm)



WOODGRAINED SHUTTERS



12"(305mm)
width

14"(356mm), &
18"(457mm)width

24"(610mm)
width

Elliptical Shutters – Plate & Batten

Part#	Width	Height(H1)	All Height(H2)	Projection
ST2EP2T W X H1 X H2 CRS	12"(305mm)	Min24" (610mm)	Max:120" (3048mm)	
ST3EP2T W X H1 X H2 CRS	14"(356mm) 18"(457mm)	in 1/4"(6mm) increments	In 1"(25mm) increments	2"(51mm)
ST4EP2T W X H1 X H2 CRS	24"(610mm)			

PART NUMBER LOGIC

ST3EP2T14X24X28CRS

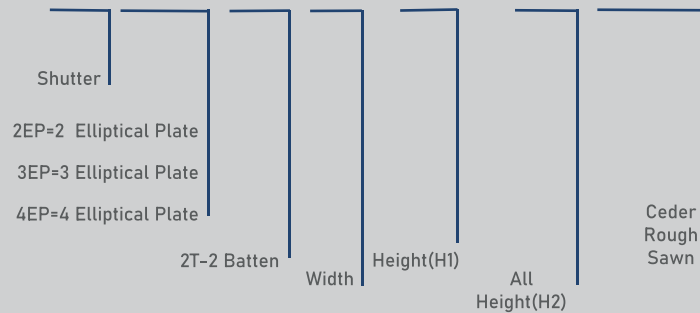

Note: Minimum height(H2) for Elliptical Plank shutters is double the width of the shutter.

Example: ST3EP2T14X24X28CRS – 14"(356mm) = width of shutter and 28"(711mm) = height(twice the width).

If a specific radius is required to complement an elliptical-shaped window, contact your customer service representative to order.

WOODGRAINED SHUTTERS



12"(305mm)
width



18"(457mm)
width

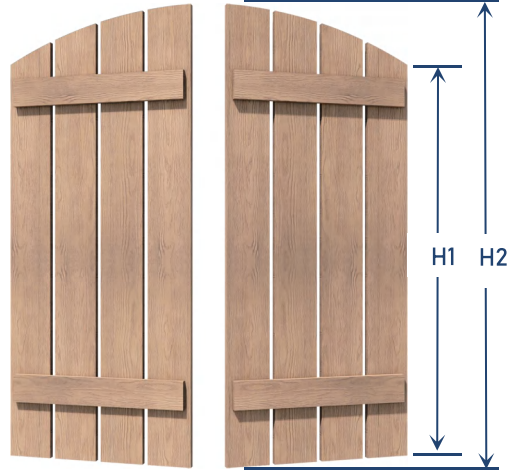

24"(610mm)
width

Elliptical Shutters – Plank

Part#	Width	Height(H1)	All Height(H2)	Projection
ST2EP2T W X H1 X H2 CRS-G	12"(305mm)	Min24" (610mm)	Max:120" (3048mm)	
ST3EP2T W X H1 X H2 CRS-G	18"(457mm)	in 1/4"(6mm) increments	In 1"(25mm) increments	2"(51mm)
ST4EP2T W X H1 X H2 CRS-G	24"(610mm)			

PART NUMBER LOGIC

ST3EP2T14X24X28CRS - G

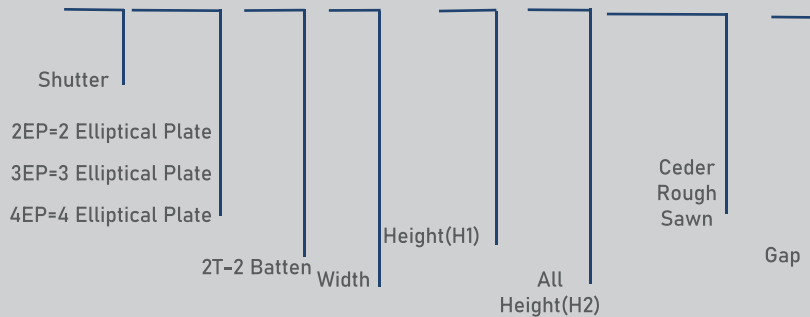

Note: Minimum height(H2) for Elliptical Plank shutters is double the width of the shutter.

Example: ST3EP2T14X24X28CRS - 14"(356mm) = width of shutter and 28"(711mm) = height(twice the width).

If a specific radius is required to complement an elliptical-shaped window, contact your customer service representative to order.

SHUTTER ASSISTANCES



Colonial PUR Hinges

Part#	Width
STHGCOL10	10"(254mm)
STHGCOL16	16"(406mm)



Spear PUR Hinges

Part#	Width
STHGSPR10	10"(254mm)
STHGSPR16	16"(406mm)



Round Clavos

Part#	Width
STCSRND1.25	1-1/4"(32mm)

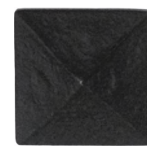





Pyramid Clavos

Part#	Width
STCSPYR1.25	1-1/4"(32mm)

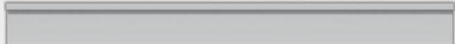
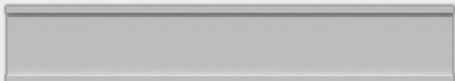

SHUTTER BOARD FABRICATION PANELS

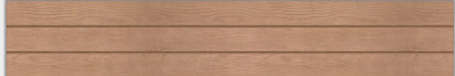
For Shaker-style and Modern Farmhouse Shaker-style

Part#	Width	Height	Thickness
 STFP12X144	12" (305mm)	144" (3658mm)	1-3/8" (35mm)
	STFP16X144	16" (406mm)	1-3/8" (35mm)
	STFP18X144	18" (457mm)	1-3/8" (35mm)
	STFP24X144	24" (610mm)	1-3/8" (35mm)
			
 FT1X3-12	2-1/2" (64mm)	144" (3658mm)	3/4" (19mm)
<hr/>			
 STB12X144CRS	12" (305mm)	144" (3658mm)	3/4" (19mm)
	STB14X144CRS	14" (356mm)	3/4" (19mm)
	STB18X144CRS	18" (457mm)	3/4" (19mm)
	STB24X144CRS	24" (610mm)	3/4" (19mm)
			
 FT1X4-12RS	3-1/2"(89mm)	144" (3658mm)	3/4" (19mm)





WOODGRAIN THICK SHUTTERS

Thicker and more 3D than ordinary products.

WOODGRAIN THICK SHUTTERS

Woodgrain Thick Panel Shutter with Border-Sanding Cedar Rough Sawn

Part#	Width	Height	Projection
ST3P2TK14X60SCRS	14" (356mm)	60" (1524mm)	2-½" (63mm)



Woodgrain Thick Panel Shutter-OAK

Part#	Width	Height	Projection
STDPK16X60KS	16" (406mm)	60" (1524mm)	1-½" (38mm)



Woodgrain Panel Shutter with Border-OAK

Part#	Width	Height	Projection
LVSTCRK14.5X60KS	14" (356mm)	60" (1524mm)	1-½" (38mm)



WOODGRAIN THICK SHUTTERS



Woodgrain Thick Panel Shutter with Border-Ceder Rough Sawn

Part#	Width	Height	Projection
ST3P2TK14X60CRS	14"(356mm)	60"(1524mm)	2-½"(63mm)



Woodgrain Thick Panel Shutter with Border-Tahoe

Part#	Width	Height	Projection
ST3P2TK14X60CS	14"(356mm)	60"(1524mm)	2-½"(63mm)



Woodgrain Thick Panel Shutter with Border-Hand Hewn

Part#	Width	Height	Projection
ST3P2TK14X60HS	14"(356mm)	60"(1524mm)	2-½"(63mm)

Shutters are sold as a pair.



MOULDING

SMOOTH FLAT TRIM



Part#	Projection	Height	Length	Part#	Projection	Height	Length
FT1X4.5X144	1"(25mm)	4-½"(114mm)	144"(3658mm)	FT159-8	1"(25mm)	5-½"(140mm)	96"(2438mm)
FT40X96	1"(25mm)	40"(1016mm)	96"(2438mm)	FT159-12	1"(25mm)	5-½"(140mm)	144"(3658mm)
FT40X96X2	2"(51mm)	40"(1016mm)	96"(2438mm)	FT159-16	1"(25mm)	5-½"(140mm)	192"(4877mm)
FT100-12	5/8"(16mm)	4-¾"(121mm)	144"(3658mm)	FT162-8	1"(25mm)	7-½"(191mm)	96"(2438mm)
FT101-12	3/4"(19mm)	1-½"(38mm)	144"(3658mm)	FT162-14	1"(25mm)	7-½"(191mm)	168"(4267mm)
FT102-10	3/4"(19mm)	2-⅛"(54mm)	120"(3048mm)	FT163-16	1-½"(38mm)	7-½"(191mm)	192"(4877mm)
FT103-12	3/4"(19mm)	3"(76mm)	144"(3658mm)	FT170-12	1"(25mm)	9-½"(241mm)	144"(3658mm)
FT109-12	3/4"(19mm)	6"(152mm)	144"(3658mm)	FT170-16	1"(25mm)	9-½"(241mm)	192"(4877mm)
FT110-16	3/4"(19mm)	5-½"(140mm)	192"(4877mm)	FT172-16	1"(25mm)	11-½"(292mm)	192"(4877mm)
FT113-8	3/4"(19mm)	8"(203mm)	96"(2438mm)	FT175-12	1"(25mm)	12"(305mm)	144"(3658mm)
FT118-8	3/4"(19mm)	10"(254mm)	96"(2438mm)	FT178-8	1/2"(13mm)	14"(356mm)	96"(2438mm)
FT119-17	1"(25mm)	32-¼"(819mm)	203"(5156mm)	FT179-12	1"(25mm)	16"(406mm)	144"(3658mm)
FT122-16	3/4"(19mm)	3-½"(89mm)	192"(4877mm)	FT180-12	1"(25mm)	24"(610mm)	144"(3658mm)
FT125-8	1"(25mm)	36"(914mm)	96"(2438mm)	FT182-12	1-½"(38mm)	12-¾"(311mm)	144"(3658mm)
FT131-16	1/2"(13mm)	3"(76mm)	192"(4877mm)	FT183-12	1-½"(38mm)	5-½"(140mm)	144"(3658mm)
FT152-8	1"(25mm)	3-½"(89mm)	96"(2438mm)	FT185-12	1-½"(38mm)	16-½"(419mm)	144"(3658mm)
FT152-12	1"(25mm)	3-½"(89mm)	144"(3658mm)	FT186-16	3/4"(19mm)	7-¾"(184mm)	192"(4877mm)
FT152-16	1"(25mm)	3-½"(89mm)	192"(4877mm)	FT190-12	2"(51mm)	4"(102mm)	144"(3658mm)
FT153-12	1"(25mm)	4"(102mm)	144"(3658mm)	FT194-10	1-½"(38mm)	3-½"(89mm)	120"(3048mm)

MOULDING



Brick mould

Part#	Projection	Height	Length
MDWM180-16	1- $\frac{1}{4}$ " (32mm)	2" (51mm)	192" (4877mm)
MDWM182-12	1- $\frac{1}{4}$ " (32mm)	3" (76mm)	144" (3658mm)



Woodgrain Brick mould

Part#	Projection	Height	Length
MDWM180-8S	1- $\frac{1}{4}$ " (32mm)	2" (51mm)	96" (2438mm)



Moulding Accessories

Part#	Projection	Height	Length
PB2.5X2.5	$\frac{3}{4}$ " (19mm)	2- $\frac{1}{2}$ " (64mm)	2- $\frac{1}{2}$ " (64mm)
PB3X3	$\frac{7}{8}$ " (22mm)	3- $\frac{5}{8}$ " (92mm)	3- $\frac{5}{8}$ " (92mm)
PB3.5X3.5	$\frac{3}{4}$ " (19mm)	3- $\frac{1}{2}$ " (89mm)	3- $\frac{1}{2}$ " (89mm)
PB3.875X3.875	1- $\frac{1}{8}$ " (29mm)	3- $\frac{7}{8}$ " (98mm)	3- $\frac{7}{8}$ " (98mm)
PB4X4	1- $\frac{1}{8}$ " (29mm)	3- $\frac{5}{8}$ " (92mm)	3- $\frac{5}{8}$ " (92mm)
PB5X5	1" (25mm)	5- $\frac{1}{4}$ " (133mm)	5- $\frac{1}{4}$ " (133mm)
PB6X6	1- $\frac{1}{8}$ " (29mm)	5- $\frac{5}{8}$ " (143mm)	5- $\frac{5}{8}$ " (143mm)









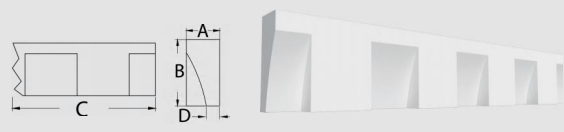
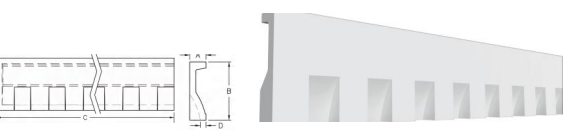
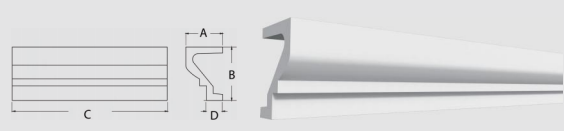
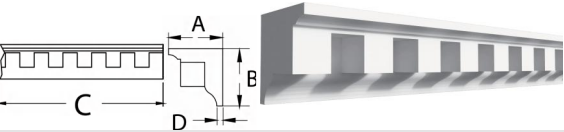

MOULDING

	Part#	Projection(A)	Height(B)	Length(C)	Bottom Thickness(D)
	MD1001-12	4-1/8" (105mm)	8-1/8" (206mm)	144" (3658mm)	1/8" (3mm)
	MD1002-12	5-1/8" (130mm)	10-1/8" (257mm)	144" (3658mm)	1/8" (3mm)
	MD1019-12	1-1/8" (29mm)	5-1/4" (133mm)	144" (3658mm)	1-1/8" (29mm)
	MD1020-12	1-1/8" (29mm)	7-1/4" (184mm)	144" (3658mm)	1-1/8" (29mm)
	MD1037-12	3-1/8" (79mm)	5-5/8" (143mm)	144" (3658mm)	1/4" (6mm)
	MD205-8	7/8" (22mm)	3" (76mm)	96" (2438mm)	-
	MD205-12	7/8" (22mm)	3" (76mm)	144" (3658mm)	-
	MD207-16	1" (25mm)	5-1/4" (133mm)	192" (4877mm)	1" (25mm)
	MD208-16	1" (25mm)	7-1/4" (184mm)	192" (4877mm)	1" (25mm)
	MD214-12	2" (51mm)	2-7/8" (73mm)	144" (3658mm)	3/4" (19mm)
	MD215-12	1-3/4" (44mm)	3-1/2" (89mm)	144" (3658mm)	3/4" (19mm)
	MD220-12	1-3/4" (44mm)	5-1/2" (140mm)	144" (3658mm)	3/4" (19mm)
	MD220-16	1-3/4" (44mm)	5-1/2" (140mm)	192" (4877mm)	3/4" (19mm)
	MD221-16	1-3/4" (44mm)	7" (178mm)	192" (4877mm)	3/4" (19mm)
	MD224-12	1-1/2" (38mm)	5-1/2" (140mm)	144" (3658mm)	3/8" (10mm)
	MD226-10	1-1/2" (38mm)	5-1/2" (140mm)	120" (3048mm)	3/4" (19mm)
	MD226-12	1-1/2" (38mm)	5-1/2" (140mm)	144" (3658mm)	3/4" (19mm)
	MD226-16	1-1/2" (38mm)	5-1/2" (140mm)	192" (4877mm)	3/4" (19mm)

MOULDING

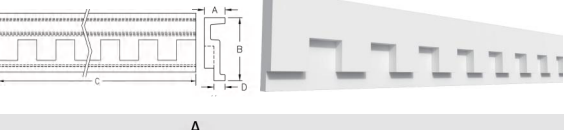
	Part#	Projection(A)	Height(B)	Length(C)	Bottom Thickness(D)
	MD227-16	1-1/2" (38mm)	9" (229mm)	192" (4877mm)	3/4" (19mm)
	MD230-12	3/4" (19mm)	3-1/4" (83mm)	144" (3658mm)	1/2" (13mm)
	MD230-16	3/4" (19mm)	3-1/4" (83mm)	192" (4877mm)	1/2" (13mm)
	MD231-12	1" (25mm)	1-3/4" (44mm)	144" (3658mm)	1/4" (6mm)
	MD234-16	1" (25mm)	3-1/2" (89mm)	192" (4877mm)	3/8" (10mm)
	MD236-16	2" (51mm)	5-1/2" (140mm)	192" (4877mm)	1-1/4" (32mm)
	MD237-16	1-1/8" (29mm)	3-1/2" (89mm)	192" (4877mm)	3/8" (10mm)
	MD240-8	3-1/4" (83mm)	4" (102mm)	96" (2438mm)	3/4" (19mm)
	MD246-16	3-3/8" (86mm)	9-1/8" (232mm)	192" (4877mm)	1" (25mm)
	MD247-16	1-3/8" (35mm)	8-3/4" (222mm)	192" (4877mm)	3/4" (19mm)
	MD250-8	1-3/4" (44mm)	4-1/2" (114mm)	96" (2438mm)	1" (25mm)
	MD250-12	1-3/4" (44mm)	4-1/2" (114mm)	144" (3658mm)	1" (25mm)
	MD253-16	2-3/8" (60mm)	7-5/8" (194mm)	192" (4877mm)	3/8" (10mm)
	MD303-5	5/8" (16mm)	1-1/4" (32mm)	60" (1524mm)	1/4" (6mm)

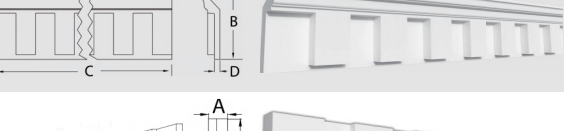
MOULDING

	Part#	Projection(A)	Height(B)	Length(C)	Bottom Thickness(D)
	MD304-8	5/8" (16mm)	1-1/2" (32mm)	96" (2438mm)	1/4" (6mm)
	MD310-8			96" (2438mm)	
	MD310-12	1-1/2" (32mm)	4-1/2" (114mm)	144" (3658mm)	1/2" (13mm)
	MD310-16			192" (4877mm)	
	MD311-16	5-3/8" (137mm)	7-3/4" (197mm)	192" (4877mm)	2-3/8" (60mm)
	MD313-8	2-1/4" (57mm)	2-3/8" (60mm)	96" (2438mm)	1/4" (6mm)
	MD320-8			96" (2438mm)	
	MD320-12	1-5/8" (41mm)	5-3/4" (146mm)	144" (3658mm)	3/8" (10mm)
	MD320-16			193-1/2" (4915mm)	
	MD330-12	1-5/8" (41mm)	7" (178mm)	144" (3658mm)	7/8" (22mm)
	MD331-16	1-3/8" (35mm)	9-1/2" (241mm)	192" (4877mm)	3/4" (19mm)
	MD332-8	1-5/8" (41mm)	5" (127mm)	96" (2438mm)	7/8" (22mm)
	MD333-12	1-3/16" (30mm)	11-1/2" (292mm)	144" (3658mm)	5/8" (16mm)
	MD335-12	3-3/8" (86mm)	6-1/8" (156mm)	144" (3658mm)	1/2" (13mm)
	MD336-16	3-1/8" (79mm)	9-3/8" (238mm)	192" (4877mm)	3/4" (19mm)
	MD350-8	7/8" (22mm)	3-1/4" (89mm)	99-3/4" (2534mm)	1/2" (13mm)

MOULDING

	Part#	Projection(A)	Height(B)	Length(C)	Bottom Thickness(D)
	MD351-8	1- $\frac{1}{4}$ " (32mm)	3- $\frac{1}{2}$ " (83mm)	98" (2489mm)	-
	MD352-8	2" (51mm)	3- $\frac{1}{2}$ " (89mm)	96" (2438mm)	-
	MD353-8	1- $\frac{1}{4}$ " (32mm)	4- $\frac{1}{2}$ " (114mm)	96- $\frac{1}{2}$ " (2445mm)	-
	MD354-12	1" (25mm)	3- $\frac{1}{8}$ " (79mm)	146- $\frac{1}{4}$ " (3715mm)	-
	MD355-8	$\frac{5}{8}$ " (16mm)	2- $\frac{1}{2}$ " (64mm)	96- $\frac{1}{2}$ " (2451mm)	-
	MD360-8	3- $\frac{1}{2}$ " (89mm)	3- $\frac{3}{4}$ " (95mm)	96" (2438mm)	-
	MD362-16	5- $\frac{1}{8}$ " (130mm)	8- $\frac{3}{8}$ " (213mm)	192" (4877mm)	-
	MD365-16	4- $\frac{7}{8}$ " (124mm)	5" (127mm)	192" (4877mm)	3/8" (10mm)
	MD370-8	6- $\frac{1}{2}$ " (165mm)	7- $\frac{1}{2}$ " (191mm)	96" (2438mm)	1" (25mm)
	MD371-16	6- $\frac{1}{2}$ " (165mm)	11" (279mm)	192" (4877mm)	1" (25mm)
	MD404-12			144" (3658mm)	1/4" (6mm)
	MD404-16			192" (4877mm)	
	MD406-16	3- $\frac{3}{8}$ " (86mm)	4" (102mm)	192" (4877mm)	3/8" (10mm)



MOULDING

	Part#	Projection(A)	Height(B)	Length(C)	Bottom Thickness(D)
	MD410-12	3- $\frac{1}{4}$ " (83mm)	6- $\frac{7}{8}$ " (175mm)	144" (3658mm)	3/8" (10mm)
	MD411-16	4- $\frac{1}{2}$ " (114mm)	7" (178mm)	192" (4877mm)	1/2" (13mm)
	MD412-16	5- $\frac{3}{8}$ " (137mm)	10- $\frac{5}{8}$ " (270mm)	192" (4877mm)	1/2" (13mm)
	MD413-12	8- $\frac{1}{2}$ " (216mm)	11- $\frac{1}{8}$ " (283mm)	144" (3658mm)	1- $\frac{1}{2}$ " (38mm)
	MD419-12	6- $\frac{3}{4}$ " (171mm)	14- $\frac{1}{2}$ " (368mm)	144" (3658mm)	1- $\frac{3}{8}$ " (35mm)
	MD421-12	10" (254mm)	14- $\frac{1}{2}$ " (368mm)	144" (3658mm)	3/4" (19mm)
	MD425-12	4- $\frac{1}{8}$ " (105mm)	9- $\frac{1}{2}$ " (241mm)	144" (3658mm)	3/4" (19mm)
	MD430-12	5- $\frac{3}{4}$ " (146mm)	8" (203mm)	144" (3658mm)	1/4" (6mm)
	MD434-16	3- $\frac{3}{4}$ " (95mm)	16" (406mm)	192" (4877mm)	1/8" (3mm)
	MD435-16	9" (229mm)	10" (254mm)	192" (4877mm)	3/4" (19mm)
	MD440-12	6- $\frac{1}{2}$ " (165mm)	7- $\frac{1}{2}$ " (184mm)	144" (3658mm)	3/8" (10mm)
	MD449-16	7- $\frac{1}{8}$ " (181mm)	8- $\frac{1}{2}$ " (216mm)	192" (4877mm)	15/16" (23mm)

MOULDING









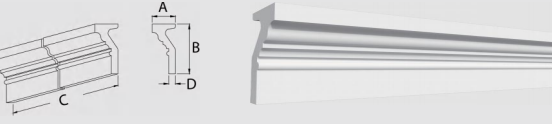
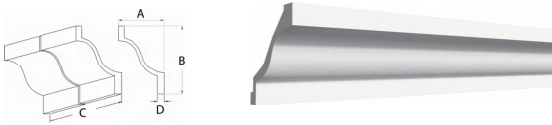

	Part#	Projection(A)	Height(B)	Length(C)	Bottom Thickness(D)
	MD450-16	11-1/2" (292mm)	9-5/8" (244mm)	192" (4877mm)	1-1/2" (38mm)
	MD451-16	3-1/8" (79mm)	3" (76mm)	192" (4877mm)	1/2" (13mm)
	MD452-12	2" (51mm)	3" (76mm)	144" (3658mm)	1/4" (6mm)
	MD453-16	4-3/4" (121mm)	6-3/4" (171mm)	192" (4877mm)	1/2" (13mm)
	MD454-12	3-5/8" (92mm)	4-1/8" (105mm)	144" (3658mm)	1/4" (6mm)
	MD456-16	2-3/4" (70mm)	4-3/8" (111mm)	192" (4877mm)	1/4" (6mm)
	MD457-12	6-7/8" (175mm)	7-5/8" (194mm)	144" (3658mm)	3/4" (19mm)
	MD460-12	4-3/8" (111mm)	5-1/8" (130mm)	144" (3658mm)	1/2" (13mm)
	MD461-8	9-7/8" (251mm)	19-13/16" (503mm)	96" (2438mm)	1" (25mm)
	MD467-16	2-3/4" (70mm)	4-3/4" (121mm)	144" (3658mm)	1/2" (13mm)
	MD472-12	11-1/4" (286mm)	15-1/2" (394mm)	144" (3658mm)	1-1/8" (29mm)
	MD481-12	14-13/16" (376mm)	17-1/2" (445mm)	144" (3658mm)	1-3/4" (44mm)

MOULDING

	Part#	Projection(A)	Height(B)	Length(C)	Bottom Thickness(D)
	MD490-12	6" (152mm)	5-1/2" (140mm)	144" (3658mm)	1/4" (6mm)
	MD505-8	3-3/8" (86mm)	13" (330mm)	96" (2438mm)	1" (25mm)
	MD506-16	3" (76mm)	16-3/8" (416mm)	192" (4877mm)	7/8" (22mm)
	MD508-12	3-5/8" (92mm)	8-3/8" (213mm)	144" (3658mm)	1-1/8" (29mm)
	MD509-16	3-1/4" (83mm)	5-3/8" (137mm)	192" (4877mm)	1-3/4" (44mm)
	MD510-12	4-3/8" (111mm)	5-1/2" (140mm)	144" (3658mm)	5/8" (16mm)
	MD511-12	5-3/4" (146mm)	6-1/2" (165mm)	144" (3658mm)	3/4" (19mm)
	MD512-16	8-1/2" (216mm)	12-1/8" (308mm)	192" (4877mm)	2-1/8" (55mm)
	MD513-16	4-1/8" (105mm)	4-3/8" (111mm)	192" (4877mm)	3/4" (19mm)
	MD520-16	6-7/16" (164mm)	8-1/8" (206mm)	192" (4877mm)	1-7/8" (48mm)
	MD521-8	5" (127mm)	13-1/8" (333mm)	96" (2438mm)	1" (25mm)
	MD522-16	1-5/8" (41mm)	14-3/4" (375mm)	192" (4877mm)	1-5/8" (41mm)









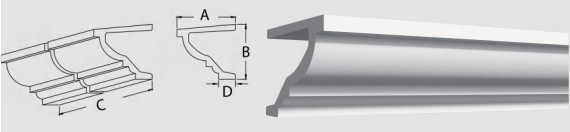
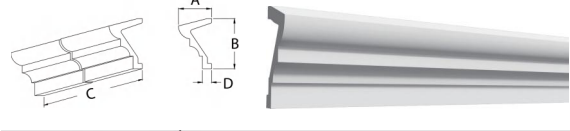

MOULDING

	Part#	Projection(A)	Height(B)	Length(C)	Bottom Thickness(D)
	MD523-16	2" (51mm)	5-1/4" (133mm)	192" (4877mm)	1/2" (13mm)
	MD524-16	8" (203mm)	12-1/8" (308mm)	192" (4877mm)	1" (25MM)
	MD527-16	3-1/4" (95mm)	7-5/8" (194mm)	192" (4877mm)	1" (25MM)
	MD528-12	9-5/8" (244mm)	15-3/4" (400mm)	144" (3658mm)	1-1/2" (38mm)
	MD530-8	1-1/2" (38mm)	12-5/8" (321mm)	96" (2438mm)	-
	MD531-8	1-1/2" (38mm)	12" (305mm)	96" (2438mm)	-
	MD533-12	5-1/2" (140mm)	17" (432mm)	144" (3658mm)	2-1/2" (64mm)
	MD534-12	8-7/8" (225mm)	19-1/8" (486mm)	144" (3658mm)	1/2" (13mm)
	MD535-16	9" (229mm)	9-1/2" (241mm)	192" (4877mm)	1/2" (13mm)
	MD536-12	8-1/8" (206mm)	15-1/2" (394mm)	144" (3658mm)	1" (25MM)
	MD539-16	4-1/2" (114mm)	12" (305mm)	192" (4877mm)	2" (51mm)
	MD543-12	8-1/4" (210mm)	19" (483mm)	144" (3658mm)	1/2" (13mm)



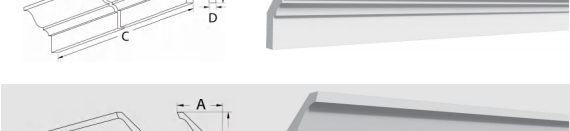

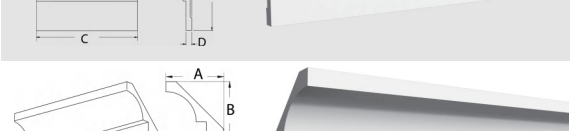
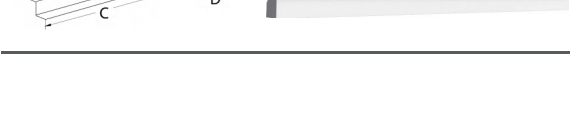







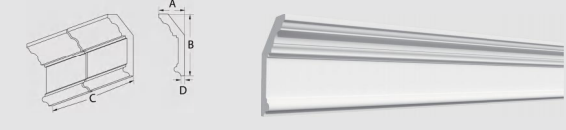

MOULDING

	Part#	Projection(A)	Height(B)	Length(C)	Bottom Thickness(D)
	MD545-12	10" (254mm)	9-1/2" (241mm)	144" (658mm)	2-7/8" (73mm)
	MD547-16	5-3/8" (137mm)	8-5/8" (219mm)	192" (4877mm)	1-1/2" (38mm)
	MD548-16	3-1/8" (79mm)	7-1/2" (191mm)	192" (4877mm)	1-1/8" (29mm)
	MD552-12	2-1/8" (54mm)	3-1/2" (89mm)	144" (3658mm)	3/8" (10mm)
	MD555-12	5-1/4" (133mm)	10-3/4" (273mm)	144" (3658mm)	7/8" (22mm)
	MD556-16	10" (254mm)	15" (381mm)	192" (4877mm)	2-1/2" (64mm)
	MD562-8	2-3/8" (60mm)	3" (76mm)	96" (2438mm)	1/2" (13mm)
	MD569-12	5-3/4" (146mm)	7-1/2" (191mm)	144" (3658mm)	1-1/8" (29mm)
	MD570-12	5-1/2" (140mm)	6-7/8" (175mm)	144" (3658mm)	3/4" (19mm)
	MD572-16	3-1/4" (83mm)	4-1/4" (108mm)	192" (4877mm)	5/8" (16mm)
	MD580-12	7-1/8" (181mm)	12-3/8" (314mm)	144" (3658mm)	1" (25mm)
	MD582-12	7-7/8" (200mm)	7-7/8" (200mm)	144" (3658mm)	2-3/8" (60mm)



MOULDING

	Part#	Projection(A)	Height(B)	Length(C)	Bottom Thickness(D)
	MD583-16	8" (203mm)	8" (203mm)	192" (4877mm)	1/2" (13mm)
	MD584-16	4-3/4" (121mm)	4-3/4" (121mm)	192" (4877mm)	3/4" (19mm)
	MD585-12	10-1/2" (267mm)	17" (432mm)	144" (3658mm)	7/8" (22mm)
	MD586-16	7" (178mm)	16-1/2" (419mm)	192" (4877mm)	1" (25mm)
	MD587-16	2-3/8" (60mm)	5-3/4" (146mm)	192" (4877mm)	3/8" (10mm)
	MD588-16	9-1/4" (235mm)	11" (279mm)	192" (4877mm)	1-3/4" (44mm)
	MD589-16	4-3/8" (111mm)	6-1/2" (165mm)	192" (4877mm)	1-1/8" (29mm)
	MD590-16	6" (152mm)	6-1/4" (159mm)	192" (4877mm)	1" (25mm)
	MD591-16	10-1/2" (260mm)	9-1/2" (241mm)	192" (4877mm)	1" (25mm)
	MD592-16	3-3/4" (95mm)	3-7/8" (98mm)	192" (4877mm)	1/4" (6mm)
	MD593-16	2-1/2" (64mm)	2-1/2" (64mm)	192" (4877mm)	1/4" (6mm)
	MD600-10	3/4" (19mm)	4-1/4" (108mm)	120" (3048mm)	1/4" (6mm)

MOULDING











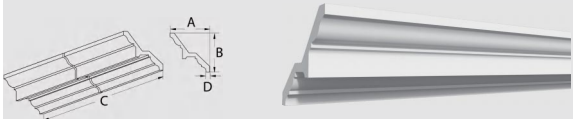
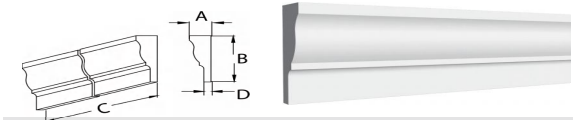

	Part#	Projection(A)	Height(B)	Length(C)	Bottom Thickness(D)
	MD601-12	1-1/2" (32mm)	1-1/2" (38mm)	144" (3658mm)	3/8" (10mm)
	MD602-8	3/4" (19mm)	3/4" (19mm)	96" (2438mm)	1/4" (6mm)
	MD603-8	1/2" (13mm)	1/2" (13mm)	96" (2438mm)	3/4" (19mm)
	MD605-12	1-3/4" (44mm)	3-1/2" (89mm)	144" (3658mm)	-
	MD606-12	5-1/4" (133mm)	5-1/4" (133mm)	144" (3658mm)	1/4" (6mm)
	MD607-8	2-1/4" (57mm)	2-1/4" (57mm)	96" (2438mm)	3/4" (19MM)
	MD610-8	1-1/2" (38mm)	2-3/8" (60mm)	96" (2438mm)	1/2" (13mm)
	MD611-12	1-1/8" (29mm)	2-1/2" (57mm)	144" (3658mm)	3/8" (10mm)
	MD612-12	3/4" (19mm)	1-3/8" (35mm)	144" (3658mm)	1/8" (3mm)
	MD613-12			144" (3658mm)	
	MD613-16			192" (4877mm)	
	MD614-16			192" (4877mm)	
	MD618-16			192" (4877mm)	

MOULDING

	Part#	Projection(A)	Height(B)	Length(C)	Bottom Thickness(D)
	MD621-16	1/2" (13mm)	2" (51mm)	192" (4877mm)	1/8" (3mm)
	MD625-16	3" (76mm)	4" (102mm)	192" (4877mm)	1-1/2" (38mm)
	MD626-8	1-1/8" (29mm)	1-1/4" (32mm)	96" (2438mm)	1/8" (3mm)
	MD627-16	1-5/8" (41mm)	2-1/8" (54mm)	192" (4877mm)	1/2" (13mm)
	MD628-8	3/4" (19mm)	3/4" (19mm)	96" (2438mm)	1/4" (6MM)
	MD629-10	2-1/2" (57mm)	2-1/2" (57mm)	120" (3048mm)	3/8" (10mm)
	MD631-16	7/8" (22mm)	3" (76mm)	192" (4877mm)	1/2" (13mm)
	MD633-8	3/4" (19mm)	3/4" (19mm)	96" (2438mm)	1/4" (6mm)
	MD634-16	1-3/8" (35mm)	1-7/8" (48mm)	192" (4877mm)	1/4" (6mm)
	MD635-12	6" (152mm)	9" (229mm)	144" (3658mm)	5/8" (16mm)
	MD637-16	1/2" (13mm)	1-1/2" (38mm)	192" (4877mm)	3/4" (19mm)
	MD639-16	1-7/8" (48mm)	6-1/4" (159mm)	192" (4877mm)	-



MOULDING

	Part#	Projection(A)	Height(B)	Length(C)	Bottom Thickness(D)
	MD640-8	1" (25mm)	5-3/4" (146mm)	96" (2438mm)	1" (25mm)
	MD641-16	3-3/4" (95mm)	4-3/8" (111mm)	192" (4877mm)	1-3/8" (10mm)
	MD642-12	12" (305mm)	11-3/4" (298mm)	144" (3658mm)	1-3/8" (35mm)
	MD644-16	3" (76mm)	9-3/4" (248mm)	192" (4877mm)	1" (25mm)
	MD649-16	1-5/8" (41mm)	2-1/8" (54mm)	192" (4877mm)	3/8" (10mm)
	MD660-10	2-3/8" (60mm)	2-3/8" (60mm)	120" (3048mm)	-
	MD705-16	3/4" (19mm)	7-1/2" (191mm)	192" (4877mm)	-
	MD706-16	5/8" (16mm)	5-1/4" (133mm)	192" (4877mm)	-
	MD710-10	3-1/2" (89mm)	1-1/2" (38mm)	120" (3048mm)	-
	MD715-16	1" (25mm)	4" (102mm)	192" (4877mm)	-
	MD716-12	1" (25mm)	1-3/4" (44mm)	144" (3658mm)	
	MD758-12	1-3/4" (44mm)	1" (25mm)	144" (3658mm)	
	MD730-8	7/8" (22mm)	1" (25mm)	96" (2438mm)	1/4" (6mm)
	MD734-12	14-1/2" (362mm)	14-1/2" (362mm)	144" (3658mm)	1-1/2" (32mm)

MOULDING

	Part#	Projection(A)	Height(B)	Length(C)	Bottom Thickness(D)
	MD4X2-10	2"(51mm)	4"(102mm)	120"(3048mm)	1/2"(13mm)
	MD6.35X4-10	4"(102mm)	6-3/8"(162mm)	120"(3048mm)	1"(25mm)
	MD901-16	2-3/8"(60mm)	4-5/8"(117mm)	16'(4877mm)	13/16"(21mm)
	MD902-16	1-3/4"(44mm)	4-11/16"(119mm)	16'(4877mm)	5/8"(16mm)
	MD903-16	7-1/16"(179mm)	6-5/16"(160mm)	16'(4877mm)	15/16"(24mm)







CEILING MEDALLIONS

CEILING MEDILLIONS

	Part#	Diameter	Inside Diameter	Projection
	CM14BL	14" (356mm)	-	1" (25mm)
	CM15BM	14- ³ / ₈ " (365mm)	1" (25mm)	2- ³ / ₄ " (70mm)
	CM16FL	16" (406mm)	4- ¹ / ₈ " (105mm)	1- ¹ / ₈ " (29mm)
	CM16JE	15- ¹ / ₂ " (394mm)	4" (102mm)	⁵ / ₈ " (16mm)
	CM16TL	16" (406mm)	4" (102mm)	1- ¹ / ₂ " (38mm)
	CM24RE	24- ³ / ₁₆ " (614mm)	-	1- ⁵ / ₁₆ " (33mm)
	CM24RN	24- ³ / ₈ " (619mm)	1" (25mm)	1- ¹ / ₂ " (38mm)
	CM31WI	30- ⁹ / ₁₆ " (777mm)	1" (25mm)	2" (51mm)
	CM32RO	31- ⁷ / ₈ " (810mm)	-	2- ¹ / ₂ " (64mm)
	CM34RE	34" (864mm)	2" (51mm)	2" (51mm)

CEILING MEDILLIONS

	Part#	Diameter	Inside Diameter	Projection
	CM36NI	35-13/16" (910mm)	2" (51mm)	2" (51mm)
	CM16JE2	15-1/2" (394mm)	5-11/16" (144mm)	5/8" (16mm)
	CM32R02	31-7/8" (810mm)	5-3/4" (146mm)	2-1/2" (64mm)





LOUVERS & GABLE VENTS

LOUVERS & GABLE VENTS



FUNCTIONAL

allows airflow to pass through the vent



DECORATIVE

same look without the airflow



Peaked Top Louvers

Part#	Functional	Width	Height	Pitch
PLV18X24-8	PLV18X24F-8	18" (457mm)	24" (610mm)	8/12
PLV18X36-10	PLV18X36F-10	18" (457mm)	36" (914mm)	10/12
PLV24X30-10	PLV24X30F-10	24" (610mm)	30" (762mm)	10/12
PLV24X36-10	PLV24X36F-10	24" (610mm)	36" (914mm)	10/12
PLV24X36-12	PLV24X36F-12	24" (610mm)	36" (914mm)	12/12

Half Round Louvers

Part#	Functional	Width	Height
HRLV24X12	HRLV24X12F	12" (305mm)	24" (610mm)
HRLV28X14	HRLV28X14F	14" (356mm)	28" (711mm)
HRLV32X16	HRLV32X16F	16" (406mm)	32" (813mm)
HRLV36X18	HRLV36X18F	18" (457mm)	36" (914mm)
HRLV40X20	HRLV40X20F	20" (508mm)	40" (1016mm)
HRLV42X21	HRLV42X21F	21" (533mm)	42" (1067mm)
HRLV48X24	HRLV48X24F	24" (610mm)	48" (1219mm)
HRLV60X30	HRLV60X30F	30" (762mm)	60" (1524mm)
HRLV72X36	HRLV72X36F	36" (914mm)	72" (1829mm)



Eyebrow Louvers

Part#	Functional	Width	Height
ELV12X24	ELV12X24F	12" (305mm)	24" (610mm)
ELV18X30	ELV18X30F	18" (457mm)	30" (762mm)
ELV22X32	ELV22X32F	22" (559mm)	32" (813mm)

LOUVERS & GABLE VENTS



Vertical Louvers

Part#	Functional	Width	Height
LV8X15	LV8X15F	8"(203mm)	15"(381mm)
LV8X24	LV8X24F	8"(203mm)	24"(610mm)
LV8X30	LV8X30F	8"(203mm)	30"(762mm)
LV12X18	LV12X18F	12"(305mm)	18"(457mm)
LV12X24	LV12X24F	12"(305mm)	24"(610mm)
LV12X30	LV12X30F	12"(305mm)	30"(762mm)
LV12X36	LV12X36F	12"(305mm)	36"(914mm)
LV12X40	LV12X40F	12"(305mm)	40"(1016mm)
LV14X27	LV14X27F	14"(356mm)	27"(686mm)
LV14X30	LV14X30F	14"(356mm)	30"(762mm)
LV14X32	LV14X32F	14"(356mm)	32"(813mm)
LV16X24	LV16X24F	16"(406mm)	24"(610mm)
LV16X36	LV16X36F	16"(406mm)	36"(914mm)
LV18X24	LV18X24F	18"(457mm)	24"(610mm)
LV18X30	LV18X30F	18"(457mm)	30"(762mm)
LV18X36	LV18X36F	18"(457mm)	36"(914mm)
LV18X42	LV18X42F	18"(457mm)	42"(1067mm)
LV20X28	LV20X28F	20"(508mm)	28"(711mm)
LV24X24	LV24X24F	24"(610mm)	24"(610mm)
LV24X30	LV24X30F	24"(610mm)	30"(762mm)
LV24X36	LV24X36F	24"(610mm)	36"(914mm)
LV24X48	LV24X48F	24"(610mm)	48"(1219mm)
LV30X42	LV30X42F	30"(762mm)	42"(1067mm)

Triangle Louvers

Part#	Functional	Width	Height	Pitch
TLV32X16	TLV32X16F	32"(813mm)	16"(406mm)	12/12
TLV36X18	TLV36X18F	36"(914mm)	18"(457mm)	12/12
TLV42X21	TLV42X21F	42"(1067mm)	21"(533mm)	12/12
TLV48X12	TLV48X12F	48"(1219mm)	12"(305mm)	6/12
TLV48X16	TLV48X16F	48"(1219mm)	16"(406mm)	8/12
TLV48X18	TLV48X18F	48"(1219mm)	18"(457mm)	9/12
TLV48X22	TLV48X22F	48"(1219mm)	22"(559mm)	11/12
TLV48X24	TLV48X24F	48"(1219mm)	24"(610mm)	12/12
TLV60X18	TLV60X18F	60"(1524mm)	17-½"(445mm)	7/12
TLV60X23	TLV60X23F	60"(1524mm)	22-½"(572mm)	9/12
TLV60X25	TLV60X25F	60"(1524mm)	25"(635mm)	10/12
TLV60X30	TLV60X30F	60"(1524mm)	30"(762mm)	12/12
TLV64X27	TLV64X27F	64"(1626mm)	26-½"(673mm)	10/12
TLV64X32	TLV64X32F	64"(1626mm)	32"(813mm)	12/12
TLV66X22	TLV66X22F	66"(1676mm)	22"(559mm)	8/12
TLV72X36	TLV72X36F	72"(1829mm)	36"(914mm)	12/12
TLV76X19	TLV76X19F	76"(1930mm)	19"(483mm)	6/12
TLV84X18	TLV84X18F	84"(2134mm)	17-½"(445mm)	5/12
TLV84X21	TLV84X21F	84"(2134mm)	21"(533mm)	6/12
TLV88X22	TLV88X22F	88"(2235mm)	22"(559mm)	6/12

LOUVERS & GABLE VENTS



Two-Piece Triangle Louver

Part#	Functional	Width	Height	Pitch
TLVLR60X25	TLVLR60X25F	60" (1524mm)	25" (635mm)	10/12
TLVLR60X30	TLVLR60X30F	60" (1524mm)	30" (762mm)	12/12
TLVLR108X27	TLVLR108X27F	108" (2743mm)	27" (686mm)	6/12
TLVLR115X35	TLVLR115X35F	115" (2921mm)	34-½" (876mm)	7-¼/12
TLVLR120X30	TLVLR120X30F	120" (3048mm)	30" (762mm)	6/12



**Round Louver
with Decorative Trim & Keystone**

Part#	Functional	Overall Width
RLV16MTK	RLV16F-MTK	17-⅛"(435mm)
RLV18MTK	RLV18F-MTK	19-⅛"(486mm)
RLV24MTK	RLV24F-MTK	25"(635mm)
RLV30MTK	RLV30F-MTK	31-⅛"(791mm)
RLV32MTK	RLV32F-MTK	32"(813mm)
RLV40MTK	RLV40F-MTK	41-¼"(1048mm)



**Half-Round Louver
with Decorative Trim & Keystones**

Part#	Functional	Width	Height
HRLV36X18DTK	HRLV36X18FTK	36" (914mm)	18-½" (470mm)



**Round Louver
with Flat Trim & Flat Keystones**

Part#	Functional	Overall Width
RLV24-4FTK	RLV24F-4FTK	32-⅞"(835mm)
RLV24-6TK	RLV24F-6TK	38"(965mm)
RLV30-6TK	RLV30F-6TK	44"(1122mm)

LOUVERS & GABLE VENTS



Oval Louver

Part#	Functional	Width	Height
OLV18X24	OVB18X24F-T	18" (457mm)	24" (610mm)
OLV25X37	OVB25X37F-T	24-½" (622mm)	37" (940mm)



Horizontal Louver

Part#	Functional	Width	Height
LV27X17	LV27X17F	27" (686mm)	17" (432mm)
LV32X16	LV32X16F	32" (813mm)	16" (406mm)



Half-Round Louver

Part#	Functional	Width	Height
HRLV36X18-4F	HRLV36X18F-4F	43" (1092mm)	25" (635mm)
HRLV36X18-6F	HRLV36X18F-6F	47" (1194mm)	29" (737mm)



Diamond Louver

Part#	Functional	Width	Height
DLV24X24	DLV24X24F	34" (864mm)	34" (864mm)



Vertical Louver

Part#	Functional	Overall Width	Height
LV18X24-T	LV18X24TF	31" (787mm)	33-½" (851mm)



Vertical Louver

Part#	Functional	Width	Height
LVNT18X24	NSLV18X24F	18" (457mm)	24" (610mm)



LOUVERS & GABLE VENTS



Cathedral Top Louvers

Part#	Functional	Width	Height
CLV12X24	CLV12X24F	12" (305mm)	24" (610mm)
CLV14X22	CLV14X22F	14" (356mm)	22" (559mm)
CLV16X36	CLV16X36F	16" (406mm)	36" (914mm)
CLV18X24	CLV18X24F	18" (457mm)	24" (610mm)
CLV18X30	CLV18X30F	18" (457mm)	30" (762mm)
CLV22X31	CLV22X31F	22" (559mm)	31-½" (800mm)
CLV24X48	CLV24X48F	24" (610mm)	48" (1219mm)
CLV28X43	CLV28X43F	28" (711mm)	43" (1092mm)
CLV36X48	CLV36X48F	36" (914mm)	48" (1219mm)



Cathedral Top Louver Trim

Part#	Outside Width	Outside Height	Inside Width	Inside Height
CLV18X30X4F	25-¼" (641mm)	37-¼" (946mm)	18-¼" (464mm)	30-¼" (768mm)
CLV22X31X4F	29-¼" (743mm)	38-11/16" (983mm)	22-¼" (565mm)	31-11/16" (805mm)



Round Louvers

Part#	Functional	Diameter
RLV12	RLV12F	12" (305mm)
RLV16	RLV16F	16" (406mm)
RLV18	RLV18F	18" (457mm)
RLV22	RLV22F	22" (559mm)
RLV24	RLV24F	24" (610mm)
RLV28	RLV28F	28" (711mm)
RLV30	RLV30F	30" (762mm)
RLV36	RLV36F	36" (914mm)
RLV42	RLV42F	42" (1067mm)
RLV48	RLV48F	48" (1219mm)

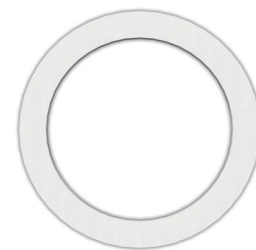

Round Louver Trim

Part#	Outside Diameter	Inside Diameter
RLV18X4F	25-¼" (641mm)	18-¼" (464mm)
RLV24X4F	31-¼" (794mm)	24-¼" (616mm)
RLV28X4F	35-¼" (895mm)	28-¼" (718mm)

LOUVERS & GABLE VENTS



Oval Louvers with Keystone

Part#	Width	Height
OVB29X20FTK	29" (737mm)	20-5/8" (524mm)



Round Louvers with Keystone

Part#	Functional	Diameter
RLV24FTK	RLV24F-FTK	24" (610mm)
RLV30FTK	RLV30F-FTK	30" (762mm)
RLV32FTK	RLV32F-FTK	31-1/2" (800mm)
RLV36FTK	RLV36F-FTK	36" (914mm)



Round Louver with Flat Trim

Part#	Functional	Diameter
RLV32-2F	RLV32F-2F	32" (813mm)



Oval Louvers with Keystone

Part#	Functional	Width	Height
OVB20X29FTK	OVB20X29F-T	20" (508mm)	29" (737mm)



LOUVERS & GABLE VENTS



Half-Round Louver

Part#	Functional	Width	Height
HRLV29-T	HRLV29-6DTK	41- ⁵ / ₈ " (1057mm)	29" (737mm)



Oval Louver-Vertical

Part#	Functional	Width	Height
OVB28X35-T	OVB28X35F-T	30" (762mm)	37- ¹ / ₂ " (953mm)



Vertical Louver

Part#	Trim Width	Width	Height
LV18X30-4F	3- ¹ / ₂ " (89mm)	25" (635mm)	37" (940mm)



Octagon Louver

Part#	Functional	Width	Height
OVA18	OVA18F	18" (457mm)	18" (457mm)
OVA22	OVA22F	22" (559mm)	22" (559mm)
OVA24	OVA24F	24" (610mm)	24" (610mm)
OVA28	OVA28F	28" (711mm)	28" (711mm)



Oval Louver-Vertical

Part#	Functional	Width	Height
OVB35X28-T	OVB35X28F-T	37- ¹ / ₂ " (953mm)	30" (762mm)



WOODGRAIN LOUVERS & GABLE VENTS



Round Louvers

Part#	Functional	Diameter
RLV16S	RLV16FS	16" (406mm)
RLV18S	RLV18FS	18" (457mm)
RLV22S	RLV22FS	22" (559mm)
RLV24S	RLV24FS	24" (610mm)
RLV28S	RLV28FS	28" (711mm)
RLV30S	RLV30FS	30" (762mm)
RLV36S	RLV36FS	36" (914mm)



Half Round Louvers

Part#	Functional	Width	Height
HRLV24X12S	HRLV24X12FS	24" (610mm)	12" (305mm)
HRLV28X14S	HRLV28X14FS	28" (711mm)	14" (356mm)
HRLV32X16S	HRLV32X16FS	32" (813mm)	16" (406mm)
HRLV36X18S	HRLV36X18FS	36" (914mm)	18" (457mm)
HRLV40X20S	HRLV40X20FS	40" (1016mm)	20" (508mm)
HRLV48X24S	HRLV48X24FS	48" (1219mm)	24" (610mm)



Oval Louvers

Part#	Functional	Width	Height
OLV18X24S	OVB18X24F-TS	18" (457mm)	24" (610mm)
OLV25X37S	OVB25X37F-TS	24-½" (622mm)	37" (940mm)



Eye Brow Louvers

Part#	Functional	Width	Height
ELV12X24S	ELV12X24FS	12" (305mm)	24" (610mm)
ELV18X30S	ELV18X30FS	18" (457mm)	30" (762mm)
ELV22X32S	ELV22X32FS	22" (559mm)	32" (813mm)

WOODGRAIN LOUVERS & GABLE VENTS



Vertical Louvers

Part#	Functional	Width	Height
LV12X18S	LV12X18FS	12" (305mm)	18" (457mm)
LV12X24S	LV12X24FS	12" (305mm)	24" (610mm)
LV12X30S	LV12X30FS	12" (305mm)	30" (762mm)
LV14X27S	LV14X27FS	14" (356mm)	27" (686mm)
LV14X30S	LV14X30FS	14" (356mm)	30" (762mm)
LV14X32S	LV14X32FS	14" (356mm)	32" (813mm)
LV16X24S	LV16X24FS	16" (406mm)	24" (610mm)
LV18X24S	LV18X24FS	18" (457mm)	24" (610mm)
LV18X30S	LV18X30FS	18" (457mm)	30" (762mm)
LV18X36S	LV18X36FS	18" (457mm)	36" (914mm)
LV20X28S	LV20X28FS	20" (508mm)	28" (711mm)
LV20X30S	LV20X30FS	20" (508mm)	30" (762mm)
LV24X24S	LV24X24FS	24" (610mm)	24" (610mm)
LV24X30S	LV24X30FS	24" (610mm)	30" (762mm)
LV24X36S	LV24X36FS	24" (610mm)	36" (914mm)

Triangle Louvers

Part#	Functional	Width	Height	Pitch
TLV32X16S	TLV32X16FS	32" (813mm)	16" (406mm)	12/12
TLV36X18S	TLV36X18FS	36" (914mm)	18" (457mm)	12/12
TLV42X21S	TLV42X21FS	42" (1067mm)	21" (533mm)	12/12
TLV48X12S	TLV48X12FS	48" (1219mm)	12" (305mm)	6/12
TLV48X16S	TLV48X16FS	48" (1219mm)	16" (406mm)	8/12
TLV48X18S	TLV48X18FS	48" (1219mm)	18" (457mm)	9/12
TLV48X22S	TLV48X22FS	48" (1219mm)	22" (559mm)	11/12
TLV48X24S	TLV48X24FS	48" (1219mm)	24" (610mm)	12/12
TLV60X18S	TLV60X18FS	60" (1524mm)	18" (457mm)	7/12
TLV60X23S	TLV60X23FS	60" (1524mm)	22-½" (572mm)	9/12
TLV60X25S	TLV60X25FS	60" (1524mm)	25" (635mm)	10/12
TLV60X30S	TLV60X30FS	60" (1524mm)	30" (762mm)	12/12
TLV64X27S	TLV64X27FS	64" (1626mm)	26-½" (673mm)	10/12
TLV64X32S	TLV64X32FS	64" (1626mm)	32" (813mm)	12/12

WOODGRAIN LOUVERS & GABLE VENTS



Round Louvers with Keystone

Part#	Functional	Diameter
RLV24FTKS	RLV24F-FTKS	24" (610mm)
RLV30FTKS	RLV30F-FTKS	30" (762mm)
RLV32FTKS	RLV32F-FTKS	31-½" (800mm)
RLV36FTKS	RLV36F-FTKS	36" (914mm)



Octagon Louver

Part#	Functional	Width	Height
OVA18S	OVA18FS	18" (457mm)	18" (457mm)
OVA22S	OVA22FS	22" (559mm)	22" (559mm)
OVA24S	OVA24FS	24" (610mm)	24" (610mm)
OVA28S	OVA28FS	28" (711mm)	28" (711mm)



Cathedral Top Louvers











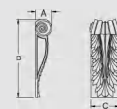

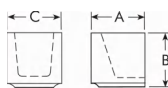
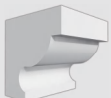

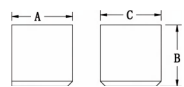

Part#	Functional	Width	Height
CLV12X24S	CLV12X24FS	12" (305mm)	24" (610mm)
CLV14X22S	CLV14X22FS	14" (356mm)	22" (559mm)
CLV16X36S	CLV16X36FS	16" (406mm)	36" (914mm)
CLV18X24S	CLV18X24FS	18" (457mm)	24" (610mm)
CLV18X30S	CLV18X30FS	18" (457mm)	30" (762mm)
CLV22X31S	CLV22X31FS	22" (559mm)	31-½" (800mm)
CLV24X48S	CLV24X48FS	24" (610mm)	48" (1219mm)
CLV28X43S	CLV28X43FS	28" (711mm)	43" (1092mm)
CLV36X48S	CLV36X48FS	36" (914mm)	48" (1219mm)



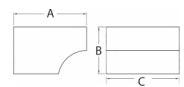

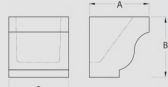
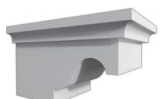
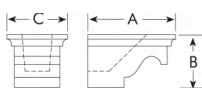

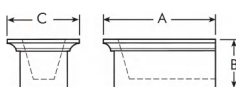





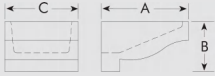

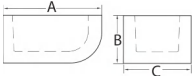

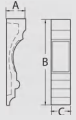

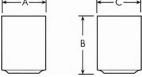
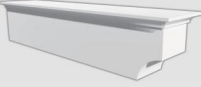
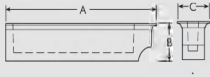
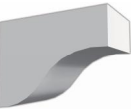
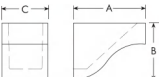
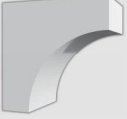
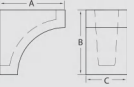
DECORATIVE MILLWORK

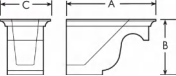

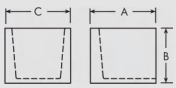

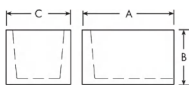

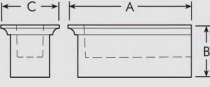

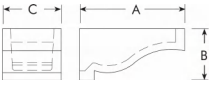



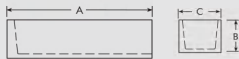

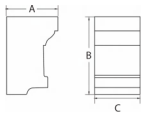

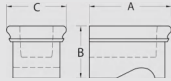

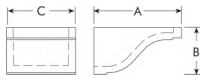

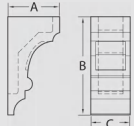

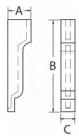

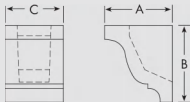
SMOOTH BRACKETS

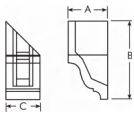
		Part#	Projection(A)	Height(B)	Width(C)
		BCD2X10	2" (51mm)	9-1/2" (241mm)	3-1/2" (89mm)
		BCD3X3X3	3-1/2" (89mm)	3-1/2" (89mm)	3-1/2" (89mm)
		BCD3X3X4	3-3/4" (95mm)	3-3/4" (95mm)	3-5/8" (92mm)
		BCD4X5X7	7-3/4" (197mm)	4-1/4" (108mm)	5-1/8" (130mm)
		BCD3X5X6	5-3/4" (146mm)	3-1/8" (79mm)	4-1/2" (114mm)
		BCD3.5X3.5X3.5	3-1/2" (89mm)	3-1/2" (89mm)	3-1/2" (89mm)
		BCD3.5X3.5X7	7-3/8" (187mm)	3-1/2" (89mm)	3-1/2" (89mm)
		BCD3.5X5.5X5.5	5-1/2" (140mm)	3-1/2" (89mm)	5-1/2" (140mm)
		BCD4X4X4	4" (102mm)	4" (102mm)	4" (102mm)
		BCD4X4X7	7-1/4" (184mm)	4-5/16" (110mm)	5" (127mm)
		BCD4X4X9	9" (229mm)	3-7/8" (98mm)	4-3/4" (121mm)
		BCD4X5X8	7-3/4" (197mm)	3-3/8" (86mm)	5" (127mm)
		BCD4X6X6	6-1/4" (159mm)	4-1/2" (114mm)	5-3/4" (146mm)

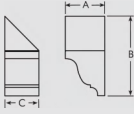

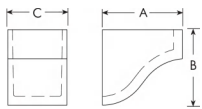

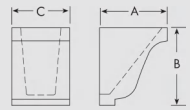

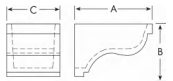



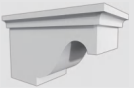
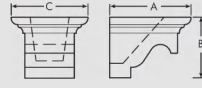

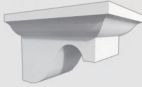
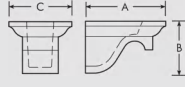

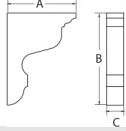

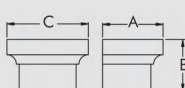

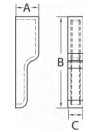

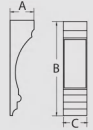
SMOOTH BRACKETS

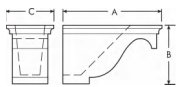
		Part#	Projection(A)	Height(B)	Width(C)
		BCD4X6X7	7-1/8" (181mm)	4" (102mm)	6" (152mm)
		BCD4X6X9	8-3/4" (222mm)	4-1/4" (108mm)	6" (152mm)
		BCD4X18X4	4" (102mm)	18" (457mm)	4" (102mm)
		BCD4.5X4X4	3-1/2" (89mm)	4-1/2" (114mm)	3-1/2" (89mm)
		BCD5X4	20-1/2" (521mm)	4-3/8" (111mm)	4-3/8" (111mm)
		BCD5X4X7	6-7/8" (175mm)	5-3/8" (137mm)	4-3/8" (111mm)
		BCD5X5X3	5-1/2" (140mm)	5-1/2" (140mm)	3-1/2" (89mm)
		BCD5X5X9	8-3/4" (222mm)	5-3/8" (137mm)	4-7/8" (124mm)
		BCD5X6X6	6" (152mm)	5" (127mm)	6" (152mm)
		BCD5X6X8	8-1/2" (216mm)	5" (127mm)	6" (152mm)
		BCD5X6X10	9-1/2" (241mm)	4-3/4" (121mm)	5-7/8" (149mm)
		BCD5X6X11	10-3/4" (273mm)	5-1/4" (133mm)	6" (152mm)

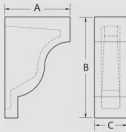

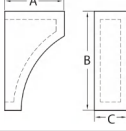

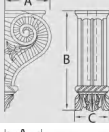

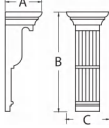



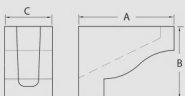

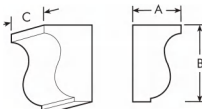



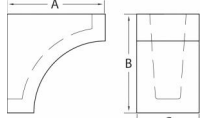

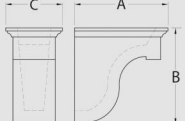

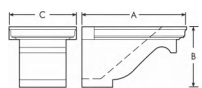

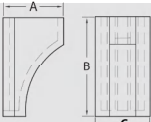
SMOOTH BRACKETS

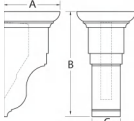
		Part#	Projection(A)	Height(B)	Width(C)
		BCD5X6X18	17-5/8" (448mm)	5" (127mm)	6" (152mm)
		BCD5X8	5-7/16" (152mm)	8-1/4" (210mm)	4-13/16" (121mm)
		BCD5X8X6	7-7/8" (200mm)	5" (127mm)	5-3/4" (146mm)
		BCD5X8X10	10" (254mm)	5-3/8" (137mm)	7-7/8" (200mm)
		BCD5X10	5-1/2" (133mm)	10" (254mm)	4" (102mm)
		BCD5X20	20" (508mm)	5" (127mm)	3" (76mm)
		BCD6X4X6	5-1/2" (140mm)	6-1/8" (156mm)	4-3/4" (121mm)
		BCD6X4X6L12	5-1/2" (140mm)	11" (279mm)	4-3/4" (121mm)
		BCD6X4X6R12	5-1/2" (140mm)	11" (279mm)	4-3/4" (121mm)
		BCD6X5X7	6-3/4" (171mm)	6-5/16" (152mm)	5" (127mm)
		BCD6X6X5	5-1/2" (140mm)	6-1/4" (159mm)	4-3/4" (121mm)
		BCD6X6X8	8" (203mm)	5-3/8" (137mm)	5-1/2" (140mm)

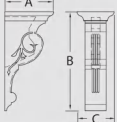

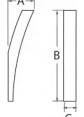

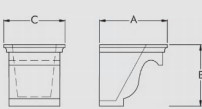

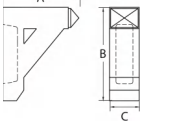

SMOOTH BRACKETS

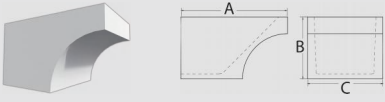
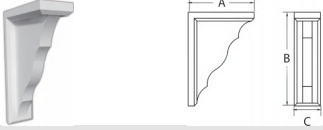
		Part#	Projection(A)	Height(B)	Width(C)
		BCD6X6X9	9- ³ / ₈ " (238mm)	5- ³ / ₄ " (146mm)	5- ¹ / ₂ " (140mm)
		BCD6X6X9.25	9- ¹ / ₄ " (235mm)	6" (152mm)	6" (152mm)
		BCD6X7X9	9- ¹ / ₄ " (235mm)	6" (152mm)	7- ¹ / ₄ " (184mm)
		BCD6X8	6" (152mm)	8" (203mm)	1- ¹ / ₂ " (38mm)
		BCD6X9X7	6- ¹ / ₂ " (165mm)	5- ¹ / ₂ " (140mm)	8- ³ / ₄ " (222mm)
		BCD6X24	6" (152mm)	24" (610mm)	4" (102mm)
		BCD6X24X6	6" (152mm)	24" (610mm)	6" (152mm)
		BCD7X6X12	11- ¹ / ₂ " (292mm)	6- ³ / ₄ " (171mm)	5- ¹ / ₂ " (140mm)
		BCD7X11X3	7" (178mm)	11" (279mm)	3- ¹ / ₂ " (89mm)
		BCD7X12X4	7- ¹ / ₄ " (184mm)	12" (51mm)	4" (102mm)
		BCD7X16	7- ¹ / ₂ " (191mm)	16- ¹ / ₂ " (159mm)	5- ¹ / ₂ " (140mm)
		BCD7X18	6- ³ / ₄ " (171mm)	18- ¹ / ₄ " (464MM)	7- ³ / ₄ " (197mm)

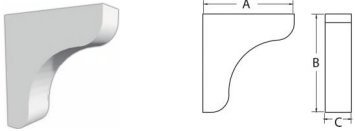
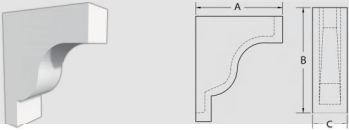

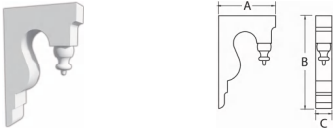

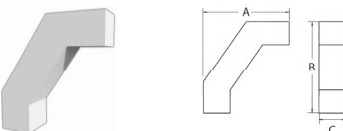
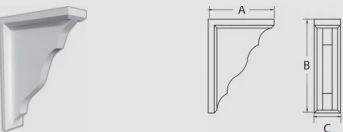





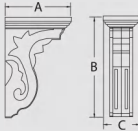

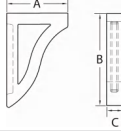

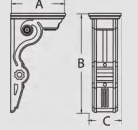

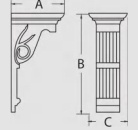

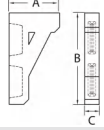

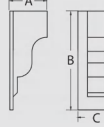

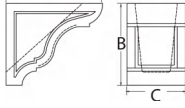
SMOOTH BRACKETS

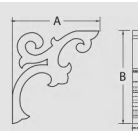
		Part#	Projection(A)	Height(B)	Width(C)
		BCD8X6	8" (203mm)	6" (152mm)	4" (102mm)
		BCD8X6X6	5-3/16" (132mm)	8-1/8" (206mm)	5-1/2" (140mm)
		BCD8X7X18	18" (457mm)	7-3/8" (187mm)	7" (178mm)
		BCD8X8	8" (203mm)	8" (203mm)	2" (51mm)
		BCD8X8X4	8" (203mm)	8" (203mm)	4-7/8" (124mm)
		BCD8X9X14	14" (102mm)	8" (203mm)	9" (229mm)
		BCD8X13	8" (203mm)	13" (330mm)	7-1/4" (184mm)
		BCD8X15	7-7/8" (200mm)	14-7/8" (378mm)	8-1/4" (210mm)
		BCD8X17	8-1/4" (210mm)	16-5/8" (422mm)	6-1/4" (159mm)
		BCD8X29X4	8-1/4" (210mm)	29" (229mm)	4" (102mm)
		BCD9X8X8	9" (229mm)	8-1/8" (206mm)	8-1/8" (206mm)
		BCD9X11	9" (229mm)	11" (279mm)	3-1/2" (89mm)

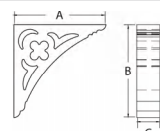

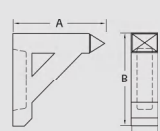

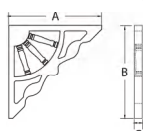

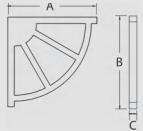

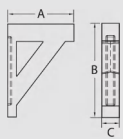

SMOOTH BRACKETS

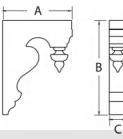
	Part#	Projection(A)	Height(B)	Width(C)
	BCD9X11X16	16" (406mm)	9-1/4" (235mm)	11-1/4" (286mm)
	BCD9X13	9" (229mm)	13" (330mm)	3" (76mm)
	BCD10X10X9	10" (254mm)	10" (254mm)	9-1/8" (232mm)
	BCD10X11	10-1/2" (267mm)	11-1/4" (286mm)	3" (76mm)
	BCD10X12X4	10" (254mm)	12" (305mm)	4" (102mm)
	BCD10X12	10-1/8" (257mm)	12-1/2" (318mm)	1" (25mm)
	BCD10X14	9-3/4" (248mm)	14-1/2" (368mm)	3-3/4" (95mm)
	BCD10X16	9-3/4" (248mm)	16" (406mm)	2-3/4" (70mm)
	BCD10X16X4	9-7/8" (251mm)	16" (406mm)	4-1/2" (114mm)
	BCD11X12X3	11-1/4" (286mm)	12" (305mm)	3-1/2" (89mm)
	BCD11X15	11" (279mm)	15" (381mm)	3" (76mm)
	BCD11X16	10-1/2" (267mm)	16-1/4" (413mm)	4-3/8" (111mm)

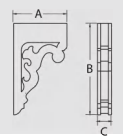
SMOOTH BRACKETS

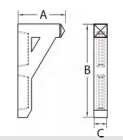

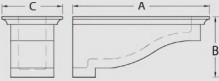

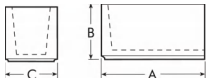





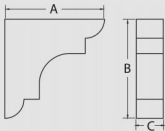

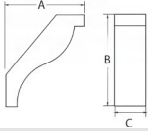

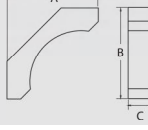

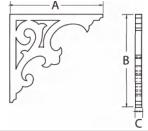

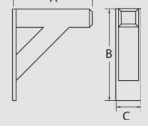

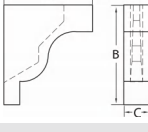

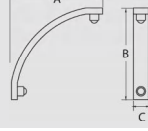
		Part#	Projection(A)	Height(B)	Width(C)
		BCD11X16X6	11" (279mm)	16- $\frac{1}{4}$ " (413mm)	6" (152mm)
		BCD11X17	11" (279mm)	17" (432mm)	2- $\frac{7}{8}$ " (73mm)
		BCD11X20X6	11" (279mm)	20" (508mm)	6- $\frac{1}{2}$ " (165mm)
		BCD14X26	14- $\frac{1}{2}$ " (368mm)	26" (660mm)	6- $\frac{1}{2}$ " (165mm)
		BCD11X20X8	11" (279mm)	20- $\frac{1}{2}$ " (521mm)	8" (203mm)
		BCD11X20	11" (279mm)	20" (508mm)	3- $\frac{1}{8}$ " (79mm)
		BCD11X30	11- $\frac{1}{2}$ " (286mm)	30" (762mm)	11- $\frac{1}{4}$ " (286mm)
		BCD12X10	12"(305m)	10- $\frac{1}{8}$ " (257mm)	7- $\frac{1}{4}$ " (184mm)
		BCD12X12	12- $\frac{1}{2}$ " (311mm)	11- $\frac{1}{2}$ " (292mm)	1- $\frac{1}{8}$ " (29mm)
		BCD12X12X3	12" (305mm)	12" (305mm)	3" (76mm)
		BCD12X12X4	12" (305mm)	12" (305mm)	3- $\frac{1}{2}$ " (89mm)
		BCD12X12GP	12" (305mm)	12" (305mm)	1" (25mm)
		BCD12X12WW	12" (305mm)	12" (305mm)	1" (25mm)

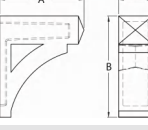
SMOOTH BRACKETS

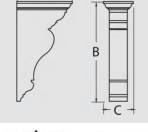

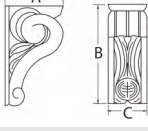

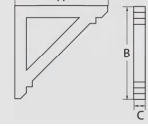

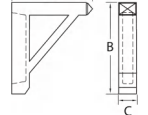



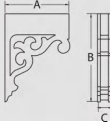

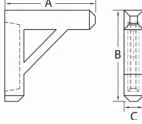
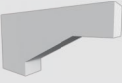
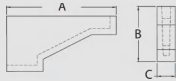

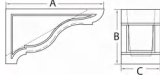

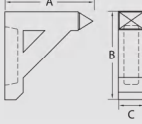

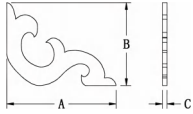

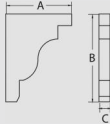
		Part#	Projection(A)	Height(B)	Width(C)
		BCD12X16	11-1/2" (292mm)	16" (406mm)	3" (76mm)
		BCD12X17	12-1/8" (308mm)	16-1/2" (419mm)	3" (76mm)
		BCD12X21X3	12-1/4" (311mm)	21-1/8" (537mm)	3-1/4" (83mm)
		BCD12X24X3	12" (305mm)	24" (610mm)	3-1/2" (89mm)
		BCD13X6	13-1/4" (337mm)	5-3/8" (146mm)	5-7/8" (149mm)
		F100	9" (229mm)	8-1/8" (206mm)	8-1/8" (206mm)

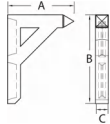

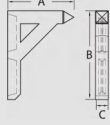

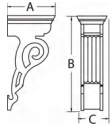

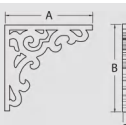

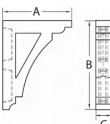



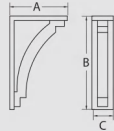

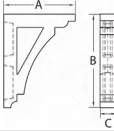

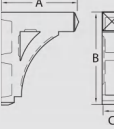

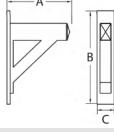



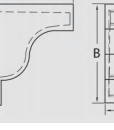

SMOOTH BRACKETS

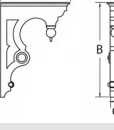
		Part#	Projection(A)	Height(B)	Width(C)
		BCD13X13X3	13" (330mm)	13" (330mm)	3-1/2" (89mm)
		BCD13X15	12-1/2" (318mm)	14-5/8" (371mm)	5" (127mm)
		BCD14X14	13-1/4" (337mm)	13-1/4" (337mm)	3-1/2" (89mm)
		BCD14X15	14" (356mm)	14-3/4" (375mm)	1" (25mm)
		BCD14X16X4	14" (356mm)	16" (406mm)	4-1/2" (114mm)
		BCD14X16	14" (356mm)	15-3/4" (146mm)	4" (102mm)
		BCD15X15	15" (381mm)	15" (381mm)	2-1/2" (64mm)
		BCD15X18X6	15" (381mm)	18" (457mm)	6" (152mm)
		BCD15X28	15-3/8" (137mm)	27-1/2" (191mm)	8-3/8" (213mm)
		BCD16X9	9-1/4" (235mm)	15-7/8" (403mm)	3-5/8" (92mm)
		BCD16X16	15-7/8" (403mm)	15-7/8" (403mm)	2" (51mm)
		BCD16X18X3	16" (406mm)	18" (457mm)	3-1/2" (89mm)

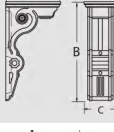



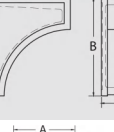

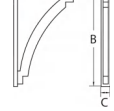

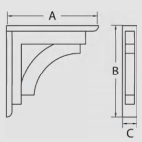

SMOOTH BRACKETS

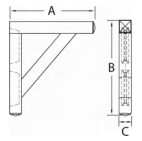
		Part#	Projection(A)	Height(B)	Width(C)
		BCD16X23X3	16- $\frac{3}{8}$ " (416mm)	22- $\frac{3}{4}$ " (578mm)	3- $\frac{1}{2}$ " (89mm)
		BCD17X17	16- $\frac{1}{2}$ " (419mm)	16- $\frac{1}{2}$ " (419mm)	3- $\frac{1}{2}$ " (89mm)
		BCD18X9X3	18" (457mm)	9" (229mm)	3" (76mm)
		BCD18X10	18" (457mm)	10- $\frac{1}{8}$ " (257mm)	7- $\frac{1}{4}$ " (184mm)
		BCD18X18X4	18" (457mm)	18" (457mm)	3- $\frac{1}{2}$ " (89mm)
		BCD18X24	24" (610mm)	18" (457mm)	1" (25mm)
		BCD18X24X3	18" (457mm)	24" (610mm)	3" (76mm)
		BCD18X24X4	18" (457mm)	24" (610mm)	3- $\frac{1}{2}$ " (89mm)
		BCD18X30X4	18" (457mm)	30" (762mm)	3- $\frac{1}{2}$ " (89mm)
		BCD18X35	17- $\frac{1}{2}$ " (445mm)	35" (889mm)	11" (279mm)
		BCD19X20	19- $\frac{1}{2}$ " (495mm)	20" (508mm)	1- $\frac{1}{8}$ " (29mm)
		BCD19X24X4	18- $\frac{5}{8}$ " (473mm)	24" (610mm)	4" (102mm)

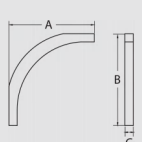
SMOOTH BRACKETS

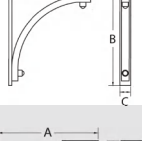
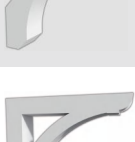
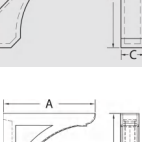
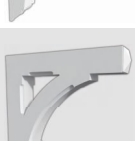
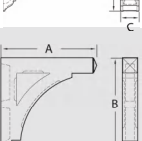

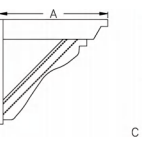
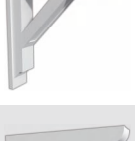
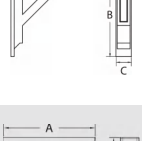
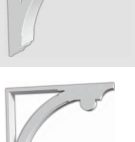
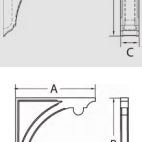

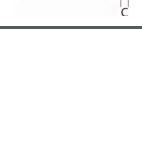





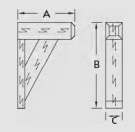

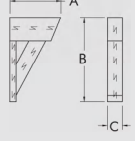

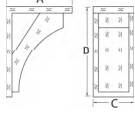

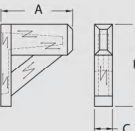

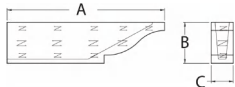

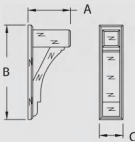
		Part#	Projection(A)	Height(B)	Width(C)
		BCD19X31	19-½" (495mm)	31-½" (800mm)	7-½" (184mm)
		BCD19X36X4	19" (483mm)	36" (914mm)	4" (102mm)
		BCD20X24X5	20" (508mm)	24" (610mm)	5" (127mm)
		BCD20X30X6	20" (508mm)	30" (762mm)	5-½" (140mm)
		BCD22X21	21-¾" (552mm)	21-½" (546mm)	3" (76mm)
		BCD22X22	22" (559mm)	22" (559mm)	2-¾" (70mm)
		BCD22X26	22-½" (572mm)	26" (660mm)	8-½" (216mm)
		BCD22X30	22" (559mm)	30" (762mm)	5-½" (140mm)
		BCD23X26	22-½" (572mm)	26" (660mm)	8-½" (216mm)
		BCD24X24X5	24" (610mm)	24" (610mm)	5" (127mm)
		BCD24X24X12	24" (610mm)	24" (610mm)	12" (305mm)
		BCD24X36	24" (610mm)	36" (914mm)	3-¾" (89mm)

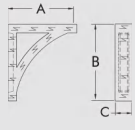
SMOOTH BRACKETS

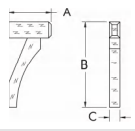

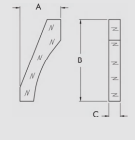

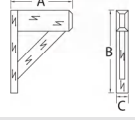

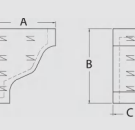



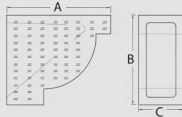

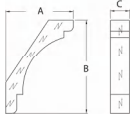

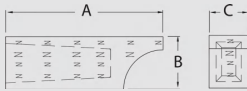

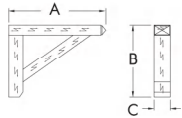

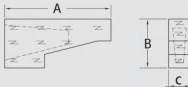

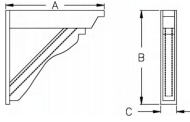

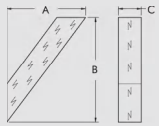

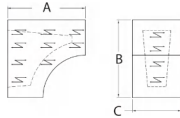
		Part#	Projection(A)	Height(B)	Width(C)
		BCD25X25	25" (635mm)	25" (635mm)	4" (102mm)
		BCD25X27	25" (635mm)	27-1/2" (699mm)	3-1/2" (89mm)
		BCD36X36X4	36" (914mm)	36" (914mm)	4" (102mm)
		BCD36X36X6	36" (914mm)	36" (914mm)	6" (152mm)
		BCD26X28	26" (660mm)	28" (711mm)	2-1/2" (64mm)
		BCD28X30	28" (711mm)	30" (762mm)	3-1/2" (89mm)
		BCD30X30X8	30" (762mm)	30" (762mm)	6-7/8" (175mm)
		BCD30X30	30" (762mm)	30" (762mm)	6" (152mm)
		BCD31X30X5	31" (787mm)	30" (762mm)	5" (127mm)
		BCD32X31X5	32-1/2" (819mm)	30-5/8" (778mm)	5-1/2" (133mm)
		BCD32X32	32" (813mm)	32" (813mm)	6" (152mm)
		BCD40X40	40" (1016mm)	40" (1016mm)	6" (152mm)
		BCD36X36	36-1/8" (918mm)	36-1/8" (918mm)	6" (152mm)
		BCD36X42	36-1/2" (921mm)	42-1/4" (1073mm)	3-1/2" (89mm)

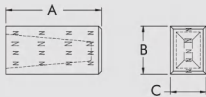

WOODGRAIN BRACKETS

		Part#	Projection(A)	Width(B)	Height(C)
 		BCD12X18X3X1S	12" (305mm)	18" (457mm)	3-1/2" (89mm)
		BCD18X18X3X1S	18" (457mm)	18" (457mm)	3-1/2" (89mm)
 		BCD12X20X3S	12" (305mm)	20" (508mm)	3-1/2" (89mm)
 		BCD13X18X8S	13" (330mm)	18" (457mm)	8" (203mm)
 		BCD14X16X3.5S	14" (356mm)	16" (406mm)	3-1/2" (89mm)
 		BCD39X10X5.5S	39" (991mm)	10" (254mm)	5-1/2" (140mm)
 		BCD14X30X7.5S	13-1/2" (343mm)	30" (762mm)	7-1/2" (191mm)
		BCD22X30X8S	21-1/2" (546mm)	30" (762mm)	7-1/2" (191mm)
 		BCD16X18X4S	16" (406mm)	18" (457mm)	4" (102mm)
 		BCD16X32X4S	16" (406mm)	32" (813mm)	4" (102mm)
 		BCD12X24X3S	12" (305mm)	24" (610mm)	3-3/8" (86mm)
 		BCD18X24X3X2S	18" (457mm)	24" (610mm)	3-1/2" (89mm)
 		BCD11X13X6S	11" (279mm)	13" (330mm)	6" (152mm)

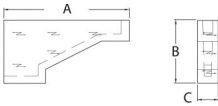
WOODGRAIN BRACKETS

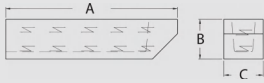



	Part#	Projection(A)	Width(B)	Height(C)
 	BCD14X12X6S	14" (356mm)	12" (305mm)	6" (152mm)
 	BCD22X30X6S	21-1/2" (546mm)	30" (762mm)	6" (152mm)
 	BCD24X8X6S	24" (610mm)	8" (203mm)	6" (152mm)
 	BCD24X18X4S	24" (610mm)	18" (457mm)	4" (102mm)
 	BCD16X7X3S	16" (406mm)	7-1/4" (184mm)	3-1/4" (83mm)
 	BCD32X31X5S	32-1/2" (826mm)	30-5/8" (778mm)	5-1/4" (133mm)
 	BCDS18X24X6S	18" (457mm)	24" (610mm)	5-1/4" (133mm)
 	BCD5X5S	5-1/2" (140mm)	5-1/2" (140mm)	5-1/2" (140mm)
 	BCD16X8S	16" (406mm)	8" (203mm)	6" (152mm)
 	BCD18X8X6S	18" (457mm)	8" (203mm)	6" (152mm)
 	BCD24X8X4S	24" (610mm)	8" (203mm)	4" (102mm)
 	BCD18X9X3S	18" (457mm)	9" (229mm)	3" (76mm)
 	BCD24X5X5S	24" (610mm)	5-1/2" (140mm)	5-1/2" (140mm)

WOODGRAIN BRACKETS

	Part#	Projection(A)	Width(B)	Height(C)
	BCD8X8X6S	8" (203mm)	8" (203mm)	6" (152mm)
	BCD5X5X3S	5-½" (140mm)	5-½" (140mm)	3-½" (89mm)
	BCD11X11X5S	11" (279mm)	11" (279mm)	5" (127mm)
	BCD7X11S	11-¾" (289mm)	7-¾" (187mm)	7" (178mm)
	BCD7X13X7S	13" (330mm)	7-¼" (184mm)	7-½" (191mm)
	BCD7X15X4S	7" (178mm)	15" (381mm)	4" (102mm)

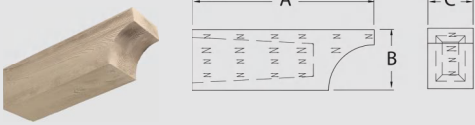
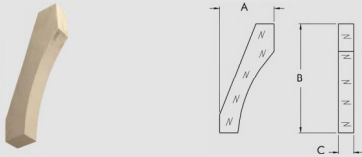
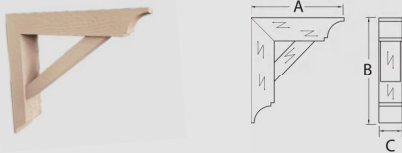

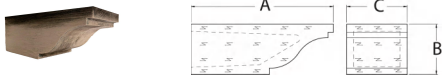
WOODGRAIN BRACKETS

	Part#	Projection(A)	Width(B)	Height(C)
	BCDCV18X8X6S	18" (457mm)	7-1/4" (184mm)	5-1/4" (133mm)
	BCDCV18X12X6S	18" (457mm)	11-1/4" (286mm)	5-1/4" (133mm)
	BCDCV18X6X6S	18" (457mm)	5-1/4" (133mm)	5-1/4" (133mm)
	BCDCV18X8X4S	18" (457mm)	7-1/4" (184mm)	3-1/4" (83mm)
	BCDCV21X30X4S	21" (533mm)	30" (762mm)	3-1/4" (83mm)
	BCDCV21X30X6S	21" (533mm)	30" (762mm)	5-1/4" (133mm)
	BCDCV18X24X4S	18" (457mm)	24" (610mm)	3-1/4" (83mm)
	BCDCV18X24X6S	18" (457mm)	24" (610mm)	5-1/4" (133mm)
	BCD26X24X6S	26" (660mm)	24" (610mm)	5-1/2" (140mm)
	BCD14X16X6S	14" (356mm)	16" (406mm)	5-1/2" (140mm)
	BCD22X24X4S	22" (559mm)	24" (610mm)	3-1/2" (89mm)
	BCD22X24X6S	22" (559mm)	24" (610mm)	5-1/2" (140mm)
	BCDOG15X7S	14-1/2" (368mm)	7-1/4" (184mm)	6" (152mm)
	BCDOGA15X7S	14-1/2" (368mm)	7-1/4" (184mm)	6" (152mm)
	BCDOG8X12S	11-3/8" (289mm)	7-3/8" (187mm)	7-3/8" (187mm)
	BCDOG20X7S	20" (508mm)	7" (178mm)	8-1/2" (216mm)
	BCDOG24X6S	24" (610mm)	5-7/8" (149mm)	5-5/8" (143mm)



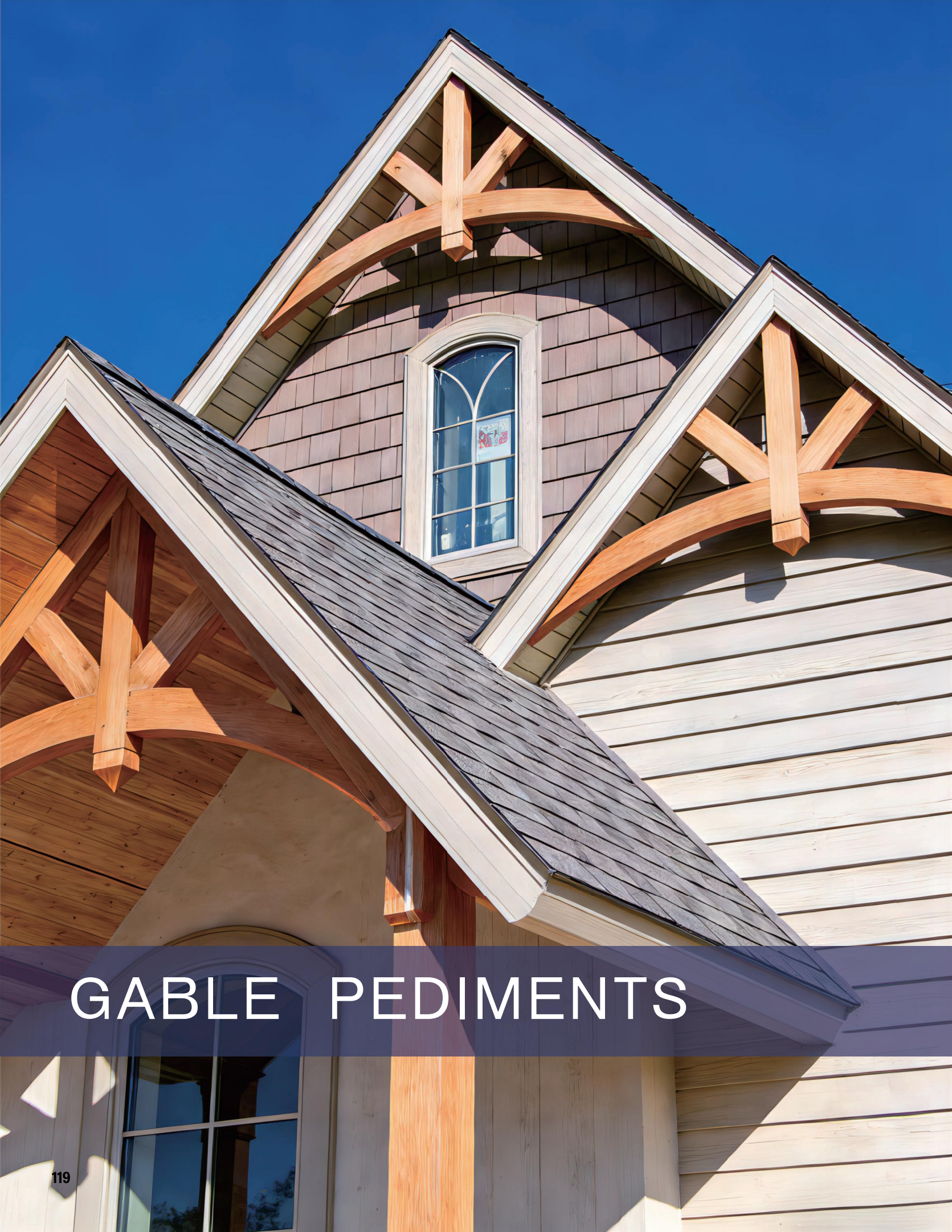

GABLE PEDIMENTS

WOODGRAIN GABLE PEDIMENTS

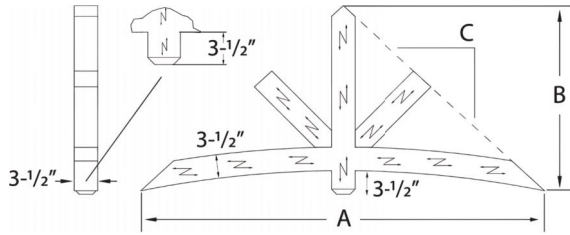

Sullivan Woodgrain Gable Pediments with Chamfered End

Part #	Overall Width(A)	Height(B)	Pitch(C)
GPSE60X17.5X3.5CRS	60"(1524mm)	17-½"(445mm)	7/12
GPSE60X20X3.5CRS	60"(1524mm)	20"(508mm)	8/12
GPSE60X22.5X3.5CRS	60"(1524mm)	22-½"(572mm)	9/12
GPSE60X25X3.5CRS	60"(1524mm)	25"(635mm)	10/12
GPSE60X27.5X3.5CRS	60"(1524mm)	27-½"(699mm)	11/12
GPSE60X30X3.5CRS	60"(1524mm)	30"(762mm)	12/12
GPSE84X28X3.5CRS	84"(2134mm)	28"(711mm)	8/12
GPSE84X31.5X3.5CRS	84"(2134mm)	31-½"(800mm)	9/12
GPSE84X35X3.5CRS	84"(2134mm)	35"(889mm)	10/12
GPSE84X38.5X3.5CRS	84"(2134mm)	38-½"(978mm)	11/12
GPSE84X42X3.5CRS	84"(2134mm)	42"(1067mm)	12/12
GPSE108X36X3.5CRS	108"(2743mm)	36"(914mm)	8/12
GPSE108X40.5X3.5CRS	108"(2743mm)	40-½"(1029mm)	9/12
GPSE108X45X3.5CRS	108"(2743mm)	45"(1143mm)	10/12
GPSE108X49.5X3.5CRS	108"(2743mm)	49-½"(1257mm)	11/12
GPSE108X54X3.5CRS	108"(2743mm)	54"(1372mm)	12/12

WOODGRAIN GABLE PEDIMENTS

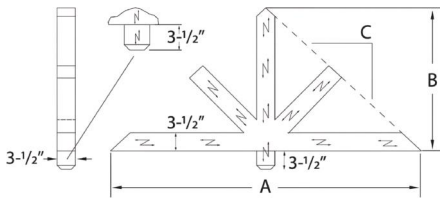

Burnham Gable Pediments

Part #with Chamfered End	Part #without Chamfered End	Overall Width(A)	Height(B)	Pitch(C)
GPBE60X12.5X3.5CRS	GPB60X12.5X3.5CRS	60"(1524mm)	12-½"(318mm)	5/12
GPBE60X15X3.5CRS	GPB60X15X3.5CRS	60"(1524mm)	15"(381mm)	6/12
GPBE60X17.5X3.5CRS	GPB60X17.5X3.5CRS	60"(1524mm)	17-½"(445mm)	7/12
GPBE60X20X3.5CRS	GPB60X20X3.5CRS	60"(1524mm)	20"(508mm)	8/12
GPBE60X22.5X3.5CRS	GPB60X22.5X3.5CRS	60"(1524mm)	22-½"(572mm)	9/12
GPBE60X25X3.5CRS	GPB60X25X3.5CRS	60"(1524mm)	25"(635mm)	10/12
GPBE60X27.5X3.5CRS	GPB60X27.5X3.5CRS	60"(1524mm)	27-½"(699mm)	11/12
GPBE60X30X3.5CRS	GPB60X30X3.5CRS	60"(1524mm)	30"(762mm)	12/12
GPBE72X15X3.5CRS	GPB72X15X3.5CRS	72"(1829mm)	15"(381mm)	5/12
GPBE72X18X3.5CRS	GPB72X18X3.5CRS	72"(1829mm)	18"(457mm)	6/12
GPBE72X21X3.5CRS	GPB72X21X3.5CRS	72"(1829mm)	21"(533mm)	7/12
GPBE72X24X3.5CRS	GPB72X24X3.5CRS	72"(1829mm)	24"(610mm)	8/12
GPBE72X27X3.5CRS	GPB72X27X3.5CRS	72"(1829mm)	27"(686mm)	9/12
GPBE72X30X3.5CRS	GPB72X30X3.5CRS	72"(1829mm)	30"(762mm)	10/12
GPBE72X33X3.5CRS	GPB72X33X3.5CRS	72"(1829mm)	33"(838mm)	11/12
GPBE72X36X3.5CRS	GPB72X36X3.5CRS	72"(1829mm)	36"(914mm)	12/12
GPBE84X17.5X3.5CRS	GPB84X17.5X3.5CRS	84"(2134mm)	17-½"(445mm)	5/12
GPBE84X21X3.5CRS	GPB84X21X3.5CRS	84"(2134mm)	21"(533mm)	6/12
GPBE84X24.5X3.5CRS	GPB84X24.5X3.5CRS	84"(2134mm)	24-½"(622mm)	7/12
GPBE84X28X3.5CRS	GPB84X28X3.5CRS	84"(2134mm)	28"(711mm)	8/12
GPBE84X31.5X3.5CRS	GPB84X31.5X3.5CRS	84"(2134mm)	31-½"(800mm)	9/12
GPBE84X35X3.5CRS	GPB84X35X3.5CRS	84"(2134mm)	35"(889mm)	10/12
GPBE84X38.5X3.5CRS	GPB84X38.5X3.5CRS	84"(2134mm)	38-½"(978mm)	11/12
GPBE84X42X3.5CRS	GPB84X42X3.5CRS	84"(2134mm)	42"(1067mm)	12/12

WOODGRAIN GABLE PEDIMENTS

Burnham Gable Pediments

Part #with Chamfered End	Part #without Chamfered End	Overall Width(A)	Height(B)	Pitch(C)
GPBE96X20X3.5CRS	GPB96X20X3.5CRS	96"(2438mm)	20"(508mm)	5/12
GPBE96X24X3.5CRS	GPB96X24X3.5CRS	96"(2438mm)	24"(610mm)	6/12
GPBE96X28X3.5CRS	GPB96X28X3.5CRS	96"(2438mm)	28"(711mm)	7/12
GPBE96X32X3.5CRS	GPB96X32X3.5CRS	96"(2438mm)	32"(813mm)	8/12
GPBE96X36X3.5CRS	GPB96X36X3.5CRS	96"(2438mm)	36"(914mm)	9/12
GPBE96X40X3.5CRS	GPB96X40X3.5CRS	96"(2438mm)	40"(1016mm)	10/12
GPBE96X44X3.5CRS	GPB96X44X3.5CRS	96"(2438mm)	44"(1626mm)	11/12
GPBE96X48X3.5CRS	GPB96X48X3.5CRS	96"(2438mm)	48"(1219mm)	12/12
GPBE108X22.5X3.5CRS	GPB108X22.5X3.5CRS	108"(2743mm)	22-½"(572mm)	5/12
GPBE108X27X3.5CRS	GPB108X27X3.5CRS	108"(2743mm)	27"(686mm)	6/12
GPBE108X31.5X3.5CRS	GPB108X31.5X3.5CRS	108"(2743mm)	31-½"(800mm)	7/12
GPBE108X36X3.5CRS	GPB108X36X3.5CRS	108"(2743mm)	36"(914mm)	8/12
GPBE108X40.5X3.5CRS	GPB108X40.5X3.5CRS	108"(2743mm)	40-½"(1029mm)	9/12
GPBE108X45X3.5CRS	GPB108X45X3.5CRS	108"(2743mm)	45"(1143mm)	10/12
GPBE108X49.5X3.5CRS	GPB108X49.5X3.5CRS	108"(2743mm)	49-½"(1257mm)	11/12
GPBE108X54X3.5CRS	GPB108X54X3.5CRS	108"(2743mm)	54"(1372mm)	12/12



WOODGRAIN GABLE PEDIMENTS

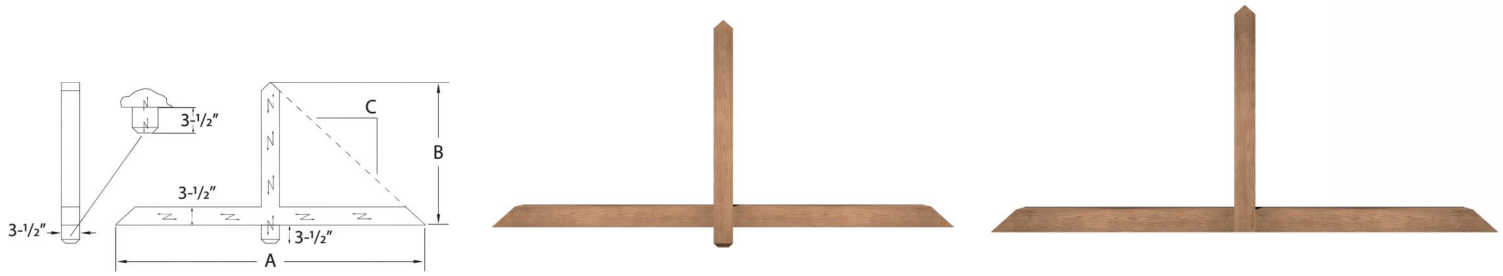

Meier Gable Pediments

Part #with Chamfered End	Part #without Chamfered End	Overall Width(A)	Height(B)	Pitch(C)
GPME60X12.5X3.5CRS	GPM60X12.5X3.5CRS	60"(1524mm)	12-½"(318mm)	5/12
GPME60X15X3.5CRS	GPM60X15X3.5CRS	60"(1524mm)	15"(381mm)	6/12
GPME60X17.5X3.5CRS	GPM60X17.5X3.5CRS	60"(1524mm)	17-½"(445mm)	7/12
GPME60X20X3.5CRS	GPM60X20X3.5CRS	60"(1524mm)	20"(508mm)	8/12
GPME60X22.5X3.5CRS	GPM60X22.5X3.5CRS	60"(1524mm)	22-½"(572mm)	9/12
GPME60X25X3.5CRS	GPM60X25X3.5CRS	60"(1524mm)	25"(635mm)	10/12
GPME60X27.5X3.5CRS	GPM60X27.5X3.5CRS	60"(1524mm)	27-½"(699mm)	11/12
GPME60X30X3.5CRS	GPM60X30X3.5CRS	60"(1524mm)	30"(762mm)	12/12
GPME72X15X3.5CRS	GPM72X15X3.5CRS	72"(1829mm)	15"(381mm)	5/12
GPME72X18X3.5CRS	GPM72X18X3.5CRS	72"(1829mm)	18"(457mm)	6/12
GPME72X21X3.5CRS	GPM72X21X3.5CRS	72"(1829mm)	21"(533mm)	7/12
GPME72X24X3.5CRS	GPM72X24X3.5CRS	72"(1829mm)	24"(610mm)	8/12
GPME72X27X3.5CRS	GPM72X27X3.5CRS	72"(1829mm)	27"(686mm)	9/12
GPME72X30X3.5CRS	GPM72X30X3.5CRS	72"(1829mm)	30"(762mm)	10/12
GPME72X33X3.5CRS	GPM72X33X3.5CRS	72"(1829mm)	33"(838mm)	11/12
GPME72X36X3.5CRS	GPM72X36X3.5CRS	72"(1829mm)	36"(914mm)	12/12
GPME84X17.5X3.5CRS	GPM84X17.5X3.5CRS	84"(2134mm)	17-½"(445mm)	5/12
GPME84X21X3.5CRS	GPM84X21X3.5CRS	84"(2134mm)	21"(533mm)	6/12

WOODGRAIN GABLE PEDIMENTS

Meier Gable Pediments

Part #with Chamfered End	Part #without Chamfered End	Overall Width(A)	Height(B)	Pitch(C)
GPME84X24.5X3.5CRS	GPM84X24.5X3.5CRS	84"(2134mm)	24-½"(622mm)	7/12
GPME84X28X3.5CRS	GPM84X28X3.5CRS	84"(2134mm)	28"(711mm)	8/12
GPME84X31.5X3.5CRS	GPM84X31.5X3.5CRS	84"(2134mm)	31-½"(800mm)	9/12
GPME84X35X3.5CRS	GPM84X35X3.5CRS	84"(2134mm)	35"(889mm)	10/12
GPME84X38.5X3.5CRS	GPM84X38.5X3.5CRS	84"(2134mm)	38-½"(978mm)	11/12
GPME84X42X3.5CRS	GPM84X42X3.5CRS	84"(2134mm)	42"(1067mm)	12/12
GPME96X20X3.5CRS	GPM96X20X3.5CRS	96"(2438mm)	20"(508mm)	5/12
GPME96X24X3.5CRS	GPM96X24X3.5CRS	96"(2438mm)	24"(610mm)	6/12
GPME96X28X3.5CRS	GPM96X28X3.5CRS	96"(2438mm)	28"(711mm)	7/12
GPME96X32X3.5CRS	GPM96X32X3.5CRS	96"(2438mm)	32"(813mm)	8/12
GPME96X36X3.5CRS	GPM96X36X3.5CRS	96"(2438mm)	36"(914mm)	9/12
GPME96X40X3.5CRS	GPM96X40X3.5CRS	96"(2438mm)	40"(1016mm)	10/12
GPME96X44X3.5CRS	GPM96X44X3.5CRS	96"(2438mm)	44"(1626mm)	11/12
GPME96X48X3.5CRS	GPM96X48X3.5CRS	96"(2438mm)	48"(1219mm)	12/12
GPME108X22.5X3.5CRS	GPM108X22.5X3.5CRS	108"(2743mm)	22-½"(572mm)	5/12
GPME108X27X3.5CRS	GPM108X27X3.5CRS	108"(2743mm)	27"(686mm)	6/12
GPME108X31.5X3.5CRS	GPM108X31.5X3.5CRS	108"(2743mm)	31-½"(800mm)	7/12
GPME108X36X3.5CRS	GPM108X36X3.5CRS	108"(2743mm)	36"(914mm)	8/12
GPME108X40.5X3.5CRS	GPM108X40.5X3.5CRS	108"(2743mm)	40-½"(1029mm)	9/12
GPME108X45X3.5CRS	GPM108X45X3.5CRS	108"(2743mm)	45"(1143mm)	10/12
GPME108X49.5X3.5CRS	GPM108X49.5X3.5CRS	108"(2743mm)	49-½"(1257mm)	11/12
GPME108X54X3.5CRS	GPM108X54X3.5CRS	108"(2743mm)	54"(1372mm)	12/12

WOODGRAIN GABLE PEDIMENTS

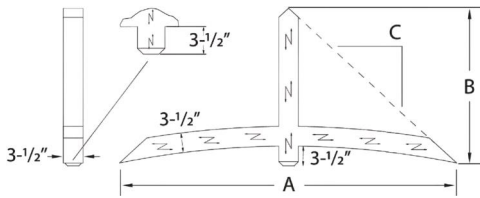

Asher Gable Pediments

Part #	Overall Width(A)	Height(B)	Pitch(C)
GPAE60X17.5X3.5CRS	60"(1524mm)	17-½"(445mm)	7/12
GPAE60X20X3.5CRS	60"(1524mm)	20"(508mm)	8/12
GPAE60X22.5X3.5CRS	60"(1524mm)	22-½"(572mm)	9/12
GPAE60X25X3.5CRS	60"(1524mm)	25"(635mm)	10/12
GPAE60X27.5X3.5CRS	60"(1524mm)	27-½"(699mm)	11/12
GPAE60X30X3.5CRS	60"(1524mm)	30"(762mm)	12/12
GPAE84X28X3.5CRS	84"(2134mm)	28"(711mm)	8/12
GPAE84X31.5X3.5CRS	84"(2134mm)	31-½"(800mm)	9/12
GPAE84X35X3.5CRS	84"(2134mm)	35"(889mm)	10/12
GPAE84X38.5X3.5CRS	84"(2134mm)	38-½"(978mm)	11/12
GPAE84X42X3.5CRS	84"(2134mm)	42"(1067mm)	12/12
GPAE108X36X3.5CRS	108"(2743mm)	36"(914mm)	8/12
GPAE108X40.5X3.5CRS	108"(2743mm)	40-½"(1029mm)	9/12
GPAE108X45X3.5CRS	108"(2743mm)	45"(1143mm)	10/12
GPAE108X49.5X3.5CRS	108"(2743mm)	49-½"(1257mm)	11/12
GPAE108X54X3.5CRS	108"(2743mm)	54"(1372mm)	12/12

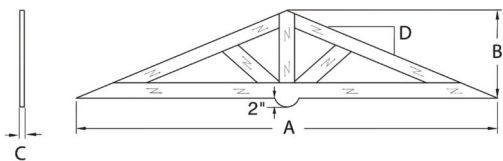

Flat Gable Pediments

Part #	Overall Width(A)	Height(B)	Pitch(C)
GPF96X20RS	96"(2438mm)	20"(508mm)	5/12
GPF96X24RS	96"(2438mm)	24"(610mm)	6/12
GPF96X28RS	96"(2438mm)	28"(711mm)	7/12

GABLE PEDIMENTS

Victorian Gable Pediments

Part#	Overall Width(A)	Overall Height(B)	Projection(C)	Pitch(D)
GP64X32	62" (1575mm)	32- $\frac{1}{4}$ " (819mm)	1" (25mm)	12/12
GP80X33	80- $\frac{1}{4}$ " (2038mm)	33- $\frac{3}{4}$ " (857mm)	1" (25mm)	9/12
GP88X29	86- $\frac{3}{8}$ " (2194mm)	29- $\frac{3}{8}$ " (746mm)	1" (25mm)	8/12
GP96X28	96" (2438mm)	28" (711mm)	1"(25mm)	7/12

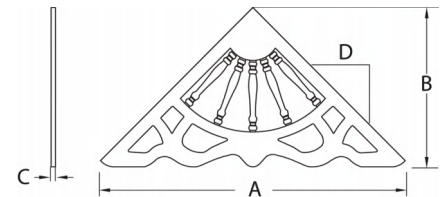

Arched Gable Pediments

Part#	Overall Width(A)	Overall Height(B)	Projection(C)	Pitch(D)
GPA70X35	70" (1778mm)	35" (889mm)	3- $\frac{1}{4}$ " (83mm)	12/12
GPA81X34	80- $\frac{1}{2}$ " (2045mm)	33- $\frac{1}{2}$ " (851mm)	3- $\frac{1}{4}$ " (83mm)	10/12
GPA86X32	85- $\frac{1}{4}$ " (2165mm)	32- $\frac{1}{4}$ " (819mm)	3- $\frac{1}{4}$ " (83mm)	9/12
GPA87X29	86- $\frac{7}{8}$ " (2207mm)	29" (737mm)	3- $\frac{1}{4}$ " (83mm)	8/12
GPA95X28	95- $\frac{1}{4}$ " (2419mm)	27- $\frac{3}{4}$ " (705mm)	3- $\frac{1}{4}$ " (83mm)	7/12
GPA104X26	103- $\frac{1}{2}$ " (2629mm)	25- $\frac{7}{8}$ " (657mm)	3- $\frac{1}{4}$ " (83mm)	6/12

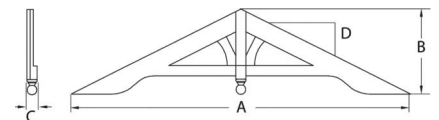
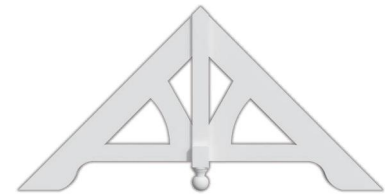

Flat Gable Pediments

Part#	Overall Width(A)	Overall Height(B)	Projection(C)	Pitch(D)
GPF66X33	66" (1676mm)	36- $\frac{1}{2}$ " (927mm)	1" (25mm)	12/12

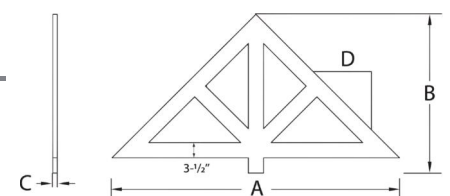
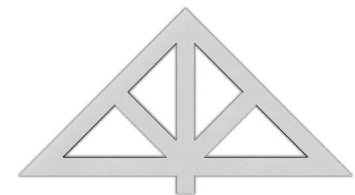

GABLE PEDIMENTS

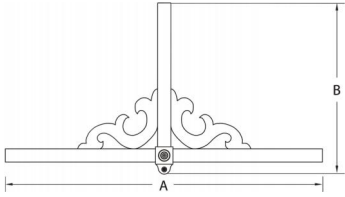
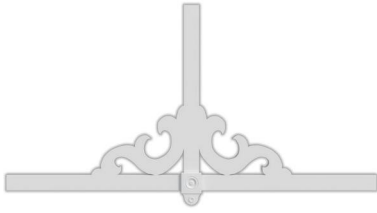

Basic Gable Pediment Kits

Part#	Overall Width(A)	Overall Height(B)	Projection(C)	Pitch
GP100	96" (2438mm)	51- ⁵ / ₈ " (1311mm)	1- ¹ / ₂ " (32mm)	Adjustable from 6 / 12 to 12 / 12



Basic Gable Pediment Kits

Part#	Overall Height(B)	Projection(C)	Pitch
GPK401	39- ¹ / ₄ " (997mm)	1- ⁵ / ₈ " (41mm)	Adjustable from 5 / 12 to 14 / 12



DECORATIVE ACCESSORIES

Porch Spandrels

	Part#	Length(A)	Height(B)	Projection(C)	Design Repeat(D)
	PRS48X8	48" (1219mm)	7- ³ / ₄ " (197mm)	1" (25mm)	5- ¹ / ₄ " (133mm)
	PRS96X8	97- ¹ / ₂ " (2477mm)	8- ¹ / ₄ " (210mm)	2- ⁷ / ₈ " (73mm)	8- ¹ / ₈ " (208mm)

Decorative Panel

	Part#	Length(A)	Height(B)	Projection(C)
	DP28X28CH	27- ³ / ₄ " (705mm)	27- ³ / ₄ " (705mm)	1- ¹ / ₂ " (38mm)
	DP28X28CH-B*	27- ³ / ₄ " (705mm)	27- ³ / ₄ " (705mm)	1- ¹ / ₂ " (38mm)
	DP28X28SQX	28" (711mm)	28" (711mm)	1- ⁵ / ₁₆ " (33mm)

*Functional

Dentil Shelf

	Part#	Length(A)	Height(B)	Projection(C)
	DSB4	25- ³ / ₈ " (645mm)	2- ⁵ / ₈ " (67mm)	2- ⁵ / ₈ " (67mm)
	DSW4	25- ³ / ₈ " (645mm)	2- ⁵ / ₈ " (67mm)	2- ⁵ / ₈ " (67mm)

DECORATIVE ACCESSORIES

Quoin

Part#	Width(A)	Length(L)	Projection(C)
QN16X96	16" (406mm)	96" (2438mm)	1-1/2" (38mm)

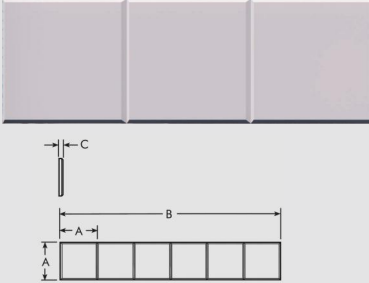

Pineapple-Half Round

Part#	Width(A)	Height(B)	Bottom Width(C)	Projection(D)
PH6X14	8-1/8" (208mm)	14-3/8" (365mm)	6-1/2" (165mm)	4-1/8" (104mm)

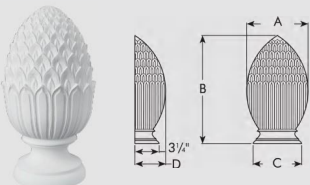

Acorn-Half Round

Part#	Width(A)	Height(B)	Bottom Width(C)	Projection(D)
A5X10	5" (127mm)	10-1/4" (260mm)	4-5/8" (117mm)	2-1/2" (64mm)
A5X12	5-1/4" (133mm)	11-7/8" (302mm)	5" (127mm)	2-5/8" (67mm)
A7X15	6-1/2" (165mm)	14-3/8" (365mm)	5-1/2" (140mm)	3-1/4" (83mm)

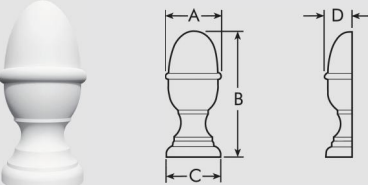



WOODGRAIN BEAMS

WOODGRAIN BEAMS

How to Choose Traditional Faux Beam

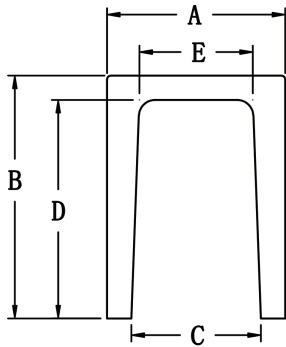

WxH Nominal Dimensions	Actual Width(A)	Actual Height(B)	Inside Top Width(C)	Inside Height(D)	Inside Bottom Width(E)
4"X4"	3-½" (89mm)	3-½" (89mm)	2" (51mm)	2-¾" (70mm)	1-¾" (44mm)
4"X6"	3-½" (89mm)	5-½" (140mm)	2" (51mm)	4-¾" (121mm)	1-⅝" (41mm)
6"X6"	5-½" (140mm)	5-½" (140mm)	4" (102mm)	4-¾" (121mm)	3-⅝" (92mm)
6"X8"	5-½" (140mm)	7-½" (191mm)	4" (102mm)	6-¾" (171mm)	3-½" (89mm)
8"X8"	7-½" (191mm)	7-½" (191mm)	6" (152mm)	6-¾" (171mm)	5-½" (140mm)
8"X10"	7-½" (191mm)	9-½" (241mm)	6" (152mm)	8-¾" (222mm)	5-⅜" (137mm)
10"X10"	9-½" (241mm)	9-½" (241mm)	8" (203mm)	8-¾" (222mm)	7-⅜" (187mm)
10"X12"	9-½" (241mm)	11-½" (292mm)	8" (203mm)	10-¾" (273mm)	7-¼" (184mm)

PART NUMBER LOGIC

BM 4 X 4 X 288 HS

BEAM

Nominal Width

Nominal Height

Length

Texture

WOODGRAIN BEAMS



Hand Hewn(HS)



Mesa(WS)



Ceder Rough Sawn(CRS)



Tahoe(CS)



Deep Sawn(DS)



Smooth

TEXTURE	Beam-Hand Hewn(HS)	Beam-Mesa(WS)	Beam-Ceder Rough Sawn(CRS)	Beam-Tahoe(CS)	Beam-Deep Sawn(DS)	Smooth
4"X4"	BM4X4X288HS	BM4X4X288WS	BM4X4X288CRS	BM4X4X288CS	BM4X4X288DS	BM4X4X288
4"X6"	BM4X6X288HS	BM4X6X288WS	BM4X6X288CRS	BM4X6X288CS	BM4X6X288DS	BM4X6X288
6"X6"	BM6X6X288HS	BM6X6X288WS	BM6X6X288CRS	BM6X6X288CS	BM6X6X288DS	BM6X6X288
6"X8"	BM6X8X288HS	BM6X8X288WS	BM6X8X288CRS	BM6X8X288CS	BM6X8X288DS	BM6X8X288
8"X8"	BM8X8X288HS	BM8X8X288WS	BM8X8X288CRS	BM8X8X288CS	BM8X8X288DS	BM8X8X288
8"X10"	BM8X10X288HS	BM8X10X288WS	BM8X10X288CRS	BM8X10X288CS	BM8X10X288DS	BM8X10X288
10"X10"	BM10X10X288HS	BM10X10X288WS	BM10X10X288CRS	BM10X10X288CS	BM10X10X288DS	BM10X10X288
10"X12"	BM10X12X288HS	BM10X12X288WS	BM10X12X288CRS	BM10X12X288CS	BM10X12X288DS	BM10X12X288

WOODGRAIN BEAMS



Light Tahoe(LCS)



Deep Cedar Rough Sawn(DRS)



White Oak Cathedral(WOS)



Sanding Cedar Rough Sawn(SRS)



New Cedar Rough Sawn (CRSN)



White Oak Straight(WSS)

TEXTURE	Light Tahoe (LCS)	Deep Cedar Rough Sawn(DRS)	Sanding Cedar Rough Sawn(SRS)	White Oak Cathedral(WOS)	White Oak Straight(WSS)	New Cedar Rough Sawn (CRSN)
6"X6"	BM6X6X144LCS	BM6X6X144DRS	BM6X6X144SRS	BM6X6X144WOS	BM6X6X144WSS	BM6X6X144CRSN
6"X8"	BM6X8X144LCS	BM6X8X144DRS	BM6X8X144SRS	BM6X8X144WOS	BM6X8X144WSS	BM6X8X144CRSN
8"X8"	BM8X8X144LCS	BM8X8X144DRS	BM8X8X144SRS	BM8X8X144WOS	BM8X8X144WSS	BM8X8X144CRSN
8"X10"	BM8X10X144LCS	BM8X10X144DRS	BM8X10X144SRS	BM8X10X144WOS	BM8X10X144WSS	BM8X10X144CRSN

*Length can be available in 12"(300mm) increments,from 12"(300mm) to MAX 144"(3650mm).For more requirements regarding length and color, please contact the sales department.



ANTIQUES

TABLE

PUTAG 202

Home Sweet Home

W

W



SMOOTH BEAM

Smooth Classic Beam

Part#	Width	Overall Width	Overall Height	Length
BM4X5X192	4- $\frac{1}{4}$ " (108mm)	6- $\frac{7}{8}$ " (175mm)	5" (127mm)	192" (4877mm)



Trim Core Beam

Part#	Width	Overall Width	Overall Height	Length
BM5X3.6X144	4- $\frac{1}{16}$ " (104mm)	5" (127mm)	3- $\frac{5}{8}$ " (92mm)	144" (3658mm)



WOODGRAIN BEAMS

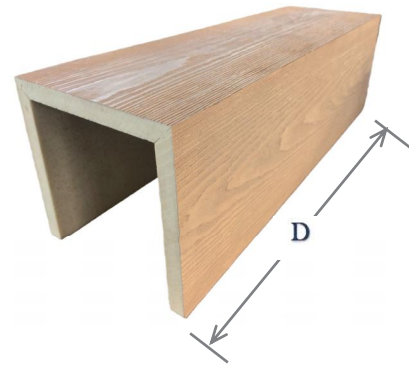
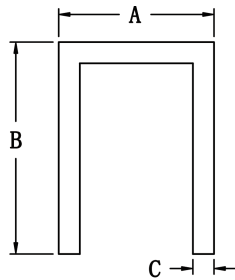

Custom Sizes Beam

Thickness(C)	Width(A)	Height(B)	Length(D)
1"(25mm)	ANY SIZE from 3"(76mm) to 12"(305mm)	ANY SIZE from 3"(76mm) to 12"(305mm)	ANY SIZE from 12"(300mm) to 288"(7300mm)

Flexible processing to meet your various needs.

PART NUMBER LOGIC

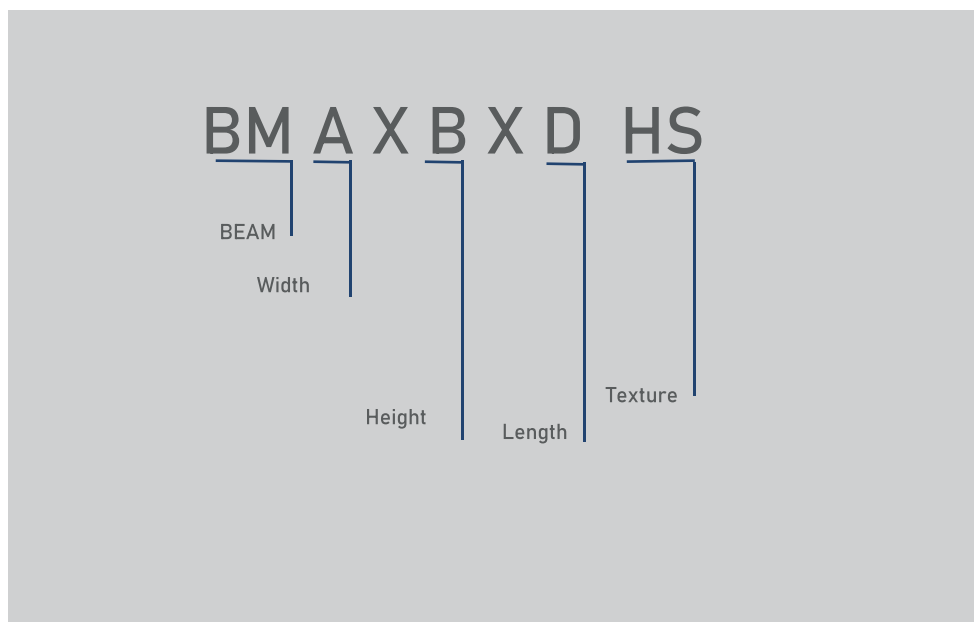

WOODGRAIN ROUND BEAMS

How to Choose Round Faux Beam

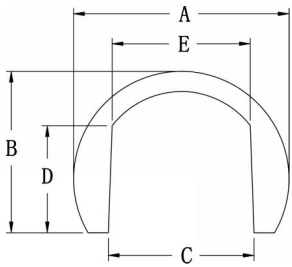

WxH Nominal Dimensions	Actual Width(A)	Actual Height(B)	Inside Top Width(C)	Inside Height(D)	Inside Bottom Width(E)
6"X4.5"	6" (152mm)	4-1/2" (114mm)	3-11/16" (94mm)	2-15/16" (74mm)	3-1/2" (89mm)
8"X6"	8" (203mm)	6" (152mm)	5-7/16" (138mm)	4" (101mm)	5-1/8" (131mm)
10"X7.5"	10" (254mm)	7-1/2" (191mm)	7-3/16" (182mm)	5-1/16" (128mm)	6-13/16" (173mm)
12"X9"	12" (305mm)	9" (229mm)	8-7/8" (226mm)	6-1/8" (155mm)	8-7/16" (215mm)

PART NUMBER LOGIC

BM 6 X 4.5 X 288 RHS

BEAM

Width

Height

Length

Round

Texture

ROUND WOODGRAIN BEAMS



Round Hand Hewn (RHS)



Round Sandblasted(RWS)



Round Adobe Peeled(RPS)









WxH Dimensions	Round Hand Hewn (RHS)	Round Sandblasted(RWS)	Round Adobe Peeled(RPS)
6"X4.5"	BM6X4.5X288RHS	BM6X4.5X288RWS	BM6X4.5X288RPS
8"X6"	BM8X6X288RHS	BM8X6X288RWS	BM8X6X288RPS
10"X7.5"	BM10X7.5X288RHS	BM10X7.5X288RWS	BM10X7.5X288RPS
12"X9"	BM12X9X288RHS	BM12X9X288RWS	BM12X9X288RPS

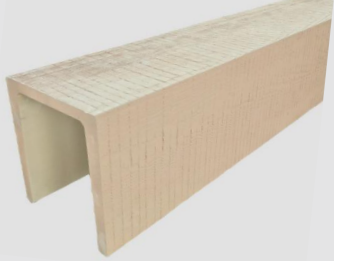

BEAM ACCESSORIES

Flat Trim for BEAM





Width	24"(610mm)	Length	144"(3658mm)	Projection	1"(25mm)
-------	------------	--------	--------------	------------	----------

	Texture	Part#	Can be used to Assembly
	Hand Hewn	BMFT1X24X144HS	
	Tahoe(CS)	BMFT1X24X144CS	
	Deep Sawn	BMFT1X24X144DS	
	Mesa	BMFT1X24X144WS	
	Smooth	BMFT1X24X144	

BEAM ACCESSORIES

Flat Trim for BEAM

Width	24"(610mm)	Length	144"(3658mm)	Projection	1"(25mm)
-------	------------	--------	--------------	------------	----------

	Texture	Part#	Can be used to Assembly
	NEW Rough Sawn	BMFT1X24X144CRSN	
	Rough Sawn	BMFT1X24X144CRS	

Differences In Detail



BEAM ACCESSORIES

Flat Trim for BEAM

Width	12"(305mm)	Length	144"(3658mm)	Projection	1"(25mm)
-------	------------	--------	--------------	------------	----------

	Texture	Part#	Can be used to Assembly
	White Oak Cathedral(WOS)	BMFT1X12X144WOS	
	Light Tahoe(LCS)	BMFT1X12X144LCS	
	Sanding Cedar Rough Sawn(SRS)	BMFT1X12X144SRS	
	Deep Cedar Rough Sawn(DRS)	BMFT1X12X144DRS	
	White Oak Straight(WSS)	BMFT1X12X144WSS	

BEAM MANTEL



Beam Mantel-Hand Hewn

Part#	Length	Width	Height
BM6X8X60HS-TC	60" (1524mm)	5-½" (140mm)	7-½" (191mm)
BM6X8X66HS-TC	66" (1676mm)		
BM6X8X72HS-TC	72" (1829mm)		
BM6X8X78HS-TC	78" (1981mm)		
BM6X8X84HS-TC	84" (2134mm)		
BM6X8X90HS-TC	90" (2286mm)		
BM8X10X60HS-TC	60" (1524mm)		
BM8X10X66HS-TC	66" (1676mm)		
BM8X10X72HS-TC	72" (1829mm)		
BM8X10X78HS-TC	78" (1981mm)		
BM8X10X84HS-TC	84" (2134mm)	7-½" (191mm)	9-½" (241mm)
BM8X10X90HS-TC	90" (2286mm)		

Beam Mantel-Rough Sawn

Part#	Length	Width	Height
BM6X8X60CRS-TC	60" (1524mm)	5-½" (140mm)	7-½" (191mm)
BM6X8X66CRS-TC	66" (1676mm)		
BM6X8X72CRS-TC	72" (1829mm)		
BM6X8X78CRS-TC	78" (1981mm)		
BM6X8X84CRS-TC	84" (2134mm)		
BM6X8X90CRS-TC	90" (2286mm)		
BM8X10X60CRS-TC	60" (1524mm)		
BM8X10X66CRS-TC	66" (1676mm)		
BM8X10X72CRS-TC	72" (1829mm)		
BM8X10X78CRS-TC	78" (1981mm)		
BM8X10X84CRS-TC	84" (2134mm)	7-½" (191mm)	9-½" (241mm)
BM8X10X90CRS-TC	90" (2286mm)		

BEAM MANTEL

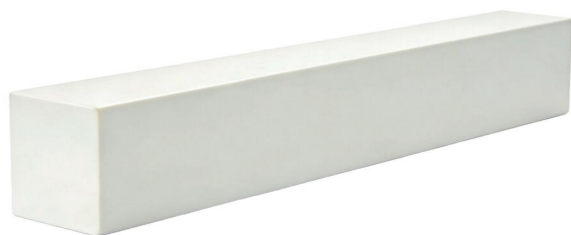

Beam Mantel-Smooth

Part#	Length	Width	Height
BM6X8X60-TC	60" (1524mm)		
BM6X8X66-TC	66" (1676mm)		
BM6X8X72-TC	72" (1829mm)	5-½" (140mm)	7-½" (191mm)
BM6X8X78-TC	78" (1981mm)		
BM6X8X84-TC	84" (2134mm)		
BM6X8X90-TC	90" (2286mm)		
BM8X10X60-TC	60" (1524mm)		
BM8X10X66-TC	66" (1676mm)		
BM8X10X72-TC	72" (1829mm)	7-½" (191mm)	9-½" (241mm)
BM8X10X78-TC	78" (1981mm)		
BM8X10X84-TC	84" (2134mm)		
BM8X10X90-TC	90" (2286mm)		



Beam Mantel-Mesa

Part#	Length	Width	Height
BM6X8X60WS-TC	60" (1524mm)		
BM6X8X66WS-TC	66" (1676mm)		
BM6X8X72WS-TC	72" (1829mm)	5-½" (140mm)	7-½" (191mm)
BM6X8X78WS-TC	78" (1981mm)		
BM6X8X84WS-TC	84" (2134mm)		
BM6X8X90WS-TC	90" (2286mm)		
BM8X10X60WS-TC	60" (1524mm)		
BM8X10X66WS-TC	66" (1676mm)		
BM8X10X72WS-TC	72" (1829mm)	7-½" (191mm)	9-½" (241mm)
BM8X10X78WS-TC	78" (1981mm)		
BM8X10X84WS-TC	84" (2134mm)		
BM8X10X90WS-TC	90" (2286mm)		



BEAM ACCESSORIES

Beam Plates-Hammered



Part#	Width	Height
BMP6X10H	5" (127mm)	10" (254mm)
BMP8X10H	7" (178mm)	10" (254mm)
BMP10X15H	9" (229mm)	15" (381mm)
BMP15X20H	14" (356mm)	20" (508mm)
BMP36X36H	36" (914mm)	36" (914mm)
BMP48X48H	48" (1219mm)	48" (1219mm)

Beam Plates-Smooth



Part#	Width	Height
BMP6X10S	5" (127mm)	10" (254mm)
BMP8X10S	7" (178mm)	10" (254mm)
BMP10X15S	9" (229mm)	15" (381mm)
BMP15X20S	14" (356mm)	20" (508mm)
BMP36X36S	36" (914mm)	36" (914mm)
BMP48X48S	48" (1219mm)	48" (1219mm)

Beam Straps-Hammered



Part#	Width	Inside Bottom Height
BMSP4X4H	3- $\frac{3}{4}$ " (95mm)	3- $\frac{1}{2}$ " (89mm)
BMSP4X6H	3- $\frac{3}{4}$ " (95mm)	5- $\frac{1}{2}$ " (140mm)
BMSP6X6H	5- $\frac{3}{4}$ " (146mm)	5- $\frac{1}{2}$ " (140mm)
BMSP6X8H	5- $\frac{3}{4}$ " (146mm)	7- $\frac{1}{2}$ " (191mm)
BMSP8X8H	7- $\frac{3}{4}$ " (197mm)	7- $\frac{1}{2}$ " (191mm)
BMSP8X10H	7- $\frac{3}{4}$ " (197mm)	9- $\frac{1}{2}$ " (241mm)
BMSP10X10H	9- $\frac{3}{4}$ " (248mm)	9- $\frac{1}{2}$ " (241mm)
BMSP10X12H	9- $\frac{3}{4}$ " (248mm)	11- $\frac{1}{2}$ " (292mm)

Beam Straps-Smooth



Part#	Width	Inside Bottom Height
BMSP4X4S	3- $\frac{3}{4}$ " (95mm)	3- $\frac{1}{2}$ " (89mm)
BMSP4X6S	3- $\frac{3}{4}$ " (95mm)	5- $\frac{1}{2}$ " (140mm)
BMSP6X6S	5- $\frac{3}{4}$ " (146mm)	5- $\frac{1}{2}$ " (140mm)
BMSP6X8S	5- $\frac{3}{4}$ " (146mm)	7- $\frac{1}{2}$ " (191mm)
BMSP8X8S	7- $\frac{3}{4}$ " (197mm)	7- $\frac{1}{2}$ " (191mm)
BMSP8X10S	7- $\frac{3}{4}$ " (197mm)	9- $\frac{1}{2}$ " (241mm)
BMSP10X10S	9- $\frac{3}{4}$ " (248mm)	9- $\frac{1}{2}$ " (241mm)
BMSP10X12S	9- $\frac{3}{4}$ " (248mm)	11- $\frac{1}{2}$ " (292mm)

BEAM ACCESSORIES

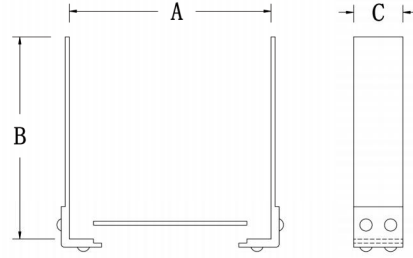

Beam Adjustable Strap-Smooth

Part#	Inside Width(A)	Inside Bottom Height(B)	Projection(C)
BMSP9.5X9.5S	9-1/2"(241.3mm)	9-1/2"(241.3mm)	2"(50.8mm)
BMSP12.5X12.5S	12-1/2"(317.5mm)	12-1/2"(317.5mm)	3"(76.2mm)
BMSP20.5X20.5S	20-1/2"(520.7mm)	20-1/2"(520.7mm)	4"(101.6mm)

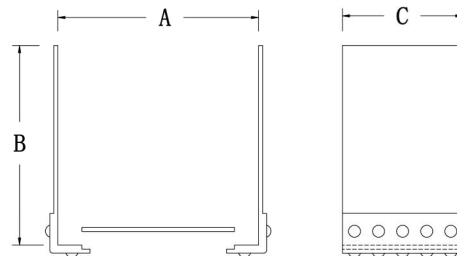

Widen Beam Adjustable Strap-Smooth

Part#	Inside Width(A)	Inside Bottom Height(B)	Projection(C)
BMSP9.5X9.5SW	9-1/2"(241.3mm)	9-1/2"(241.3mm)	5"(127.0mm)
BMSP12.5X12.5SW	12-1/2"(317.5mm)	12-1/2"(317.5mm)	7-1/2"(190.5mm)
BMSP20.5X20.5SW	20-1/2"(520.7mm)	20-1/2"(520.7mm)	10"(254.0mm)

BEAM ACCESSORIES

Beam End Cap

Part#	Width	Projection	Length
BC4X4	4" (102mm)	3/4" (19mm)	4" (102mm)
BC4X6	4" (102mm)	3/4" (19mm)	6" (152mm)
BC6X6	6" (152mm)	3/4" (19mm)	6" (152mm)
BC6X8	6" (152mm)	3/4" (19mm)	8" (203mm)
BC8X8	8" (203mm)	3/4" (19mm)	8" (203mm)
BC8X10	8" (203mm)	3/4" (19mm)	10" (254mm)
BC10X10	10" (254mm)	3/4" (19mm)	10" (254mm)
BC10X12	10" (254mm)	3/4" (19mm)	12" (305mm)

Beam Top-Mesa

Part#	Width	Projection	Length
BM6X144T	5-1/2" (140mm)	3/4" (19mm)	144" (3658mm)
BM8X144T	7-1/2" (191mm)	3/4" (19mm)	144" (3658mm)



WOODGRAIN RAFTER TAILS



Bullnose Profile	Cove Profile	Scroll Profile	Slant Profile	Straight Profile	Part#	A	B	C
BMBL4X6X12RS	BMCV4X6X12RS	BMSC4X6X12RS	BMSL4X6X12RS	BMST4X6X12RS		12" (305mm)		
BMBL4X6X18RS	BMCV4X6X18RS	BMSC4X6X18RS	BMSL4X6X18RS	BMST4X6X18RS		18" (457mm)		
BMBL4X6X24RS	BMCV4X6X24RS	BMSC4X6X24RS	BMSL4X6X24RS	BMST4X6X24RS		24" (610mm)		
BMBL4X6X30RS	BMCV4X6X30RS	BMSC4X6X30RS	BMSL4X6X30RS	BMST4X6X30RS		30" (762mm)	3-½" (89mm)	5-½" (140mm)
BMBL4X6X36RS	BMCV4X6X36RS	BMSC4X6X36RS	BMSL4X6X36RS	BMST4X6X36RS		36"(914mm)		
BMBL4X6X42RS	BMCV4X6X42RS	BMSC4X6X42RS	BMSL4X6X42RS	BMST4X6X42RS		42" (1067mm)		
BMBL4X8X18RS	BMCV4X8X18RS	BMSC4X8X18RS	BMSL4X8X18RS	BMST4X8X18RS		18" (457mm)		
BMBL4X8X24RS	BMCV4X8X24RS	BMSC4X8X24RS	BMSL4X8X24RS	BMST4X8X24RS		24" (610mm)		
BMBL4X8X30RS	BMCV4X8X30RS	BMSC4X8X30RS	BMSL4X8X30RS	BMST4X8X30RS		30" (762mm)	3-½" (89mm)	7-½" (191mm)
BMBL4X8X36RS	BMCV4X8X36RS	BMSC4X8X36RS	BMSL4X8X36RS	BMST4X8X36RS		36"(914mm)		
BMBL4X8X42RS	BMCV4X8X42RS	BMSC4X8X42RS	BMSL4X8X42RS	BMST4X8X42RS		42" (1067mm)		

WOODGRAIN RAFTER TAILS

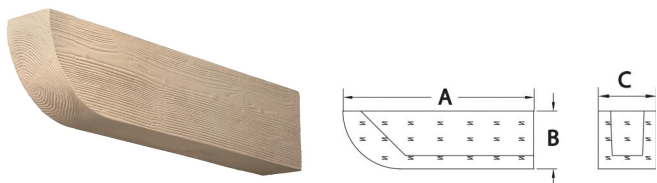

Rafter Tails Standard Woodgrain

Part#	Length(A)	B(Height)	Width(C)
BMS6X4X24S	24" (610mm)	5-1/4" (133mm)	3-1/4" (83mm)
BMS8X4X24S	24" (610mm)	7-1/4" (184mm)	3-1/4" (83mm)

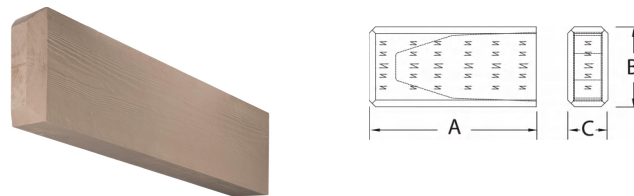

Rafter Tails Standard Woodgrain

Part#	Length(A)	Height(B)	Width(C)
BMT25X12X6S	25" (635mm)	12" (305mm)	6" (152mm)



Rafter Tails Double-Ended Standard Woodgrain

Part#	Length(A)	Height(B)	Width(C)
BMT4X8X42S	4" (102mm)	8" (203mm)	41-1/4" (1060mm)



BALUSTRADES & COLUMNS

LEGEN BALUSTRADE RECOMMEND

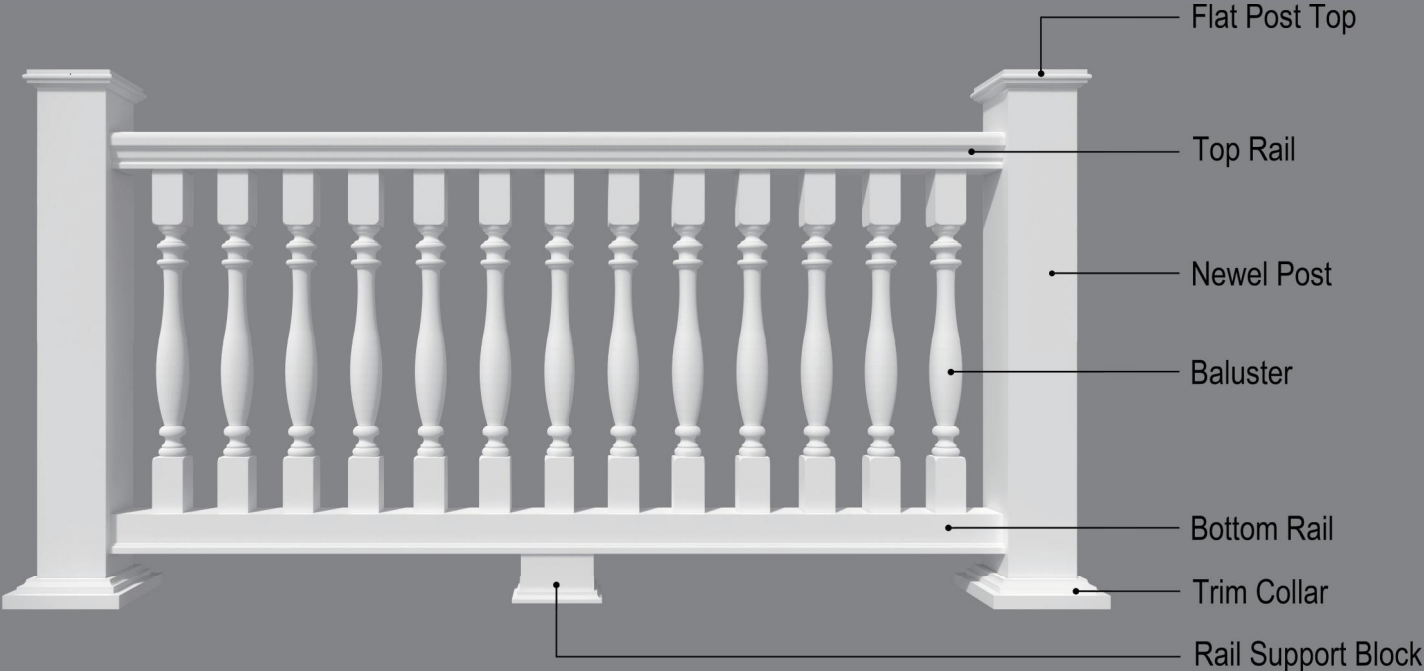

Other choices:



Post Ball



Newel Post



Column



5" BALUSTRADE SYSTEM



Top Straight Rails

Part#	Top Width(A)	Bottom Width(B)	Height(C)	Length
TR5X96	4-5/8" (117mm)	3-1/2" (83mm)	3-1/8" (79mm)	96" (2438mm)
TR5X144				144" (3658mm)

Bottom Straight Rails

Part#	Top Width(A)	Bottom Width(B)	Height(C)	Length
BR5X96	3-3/4" (95mm)	4-1/2" (114mm)	3-1/8" (79mm)	96" (2438mm)
BR5X144				144" (3658mm)

Rail Support Block

Part#	Top Width	Top Length	Height	Coordinate
RS2X4X6	2" (51mm)	6" (152mm)	4" (102mm)	Rail 5"/7"
RS4X4X6	4" (102mm)	6" (152mm)	4" (152mm)	

Balustrade Rail Installation Kits

Part#	Kit Contents	Installation Notes
BRK5	(2) Angle Brackets & Mounting Hardware (6) White flat screws	Connects both ends of one 5" top or bottom rail to support structure. Order two kits per section.

5" BALUSTRADE SYSTEM

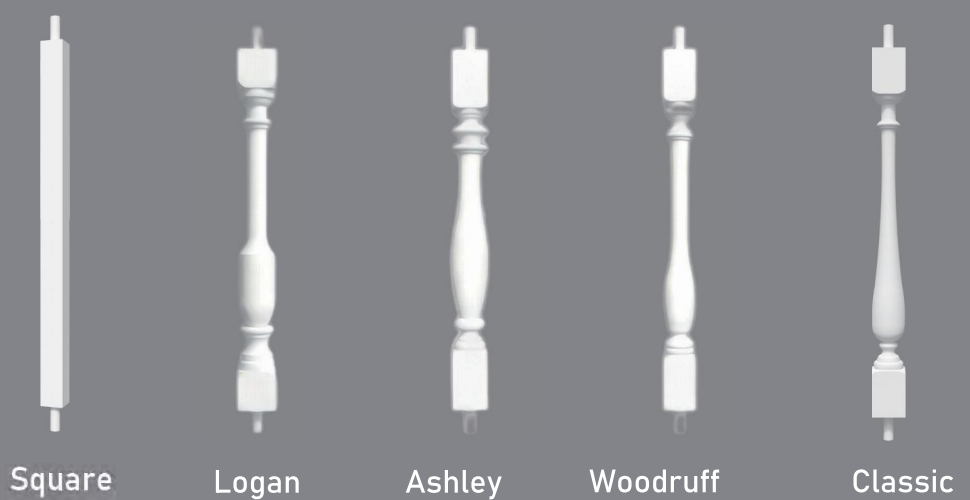
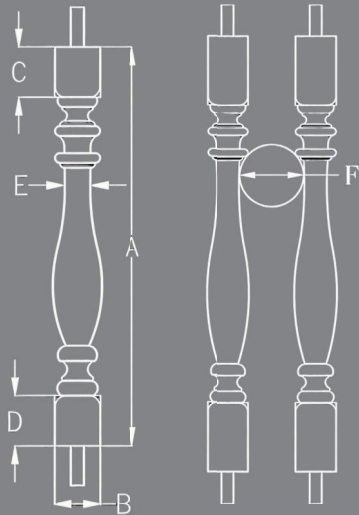

Spindle Height-A
Spindle Width-B

Top Block Height-C
Bottom Block Height-D

Spindle Thinnest Width-E
Maximum Center-to-Center Distance-F

	Part#	A	B	C	D	E	F
Square	BL2X20Q	20"(508mm)	1-3/4"(44mm)	-	-	-	5-3/8"(137mm)
	BL2X24Q	24"(610mm)	1-3/4"(44mm)	-	-	-	5-3/8"(137mm)
	BL2X28Q	28"(711mm)	1-3/4"(44mm)	-	-	-	5-3/8"(137mm)
	BL2X32Q	32"(813mm)	1-3/4"(44mm)	-	-	-	5-3/8"(137mm)
Logan	BL3X24L	24"(610mm)	3"(76mm)	3"(76mm)	3"(76mm)	1-1/2"(38mm)	5-1/2"(140mm)
	BL3X28L	28"(711mm)	3"(76mm)	3"(76mm)	3"(76mm)	1-1/2"(38mm)	5-1/2"(140mm)
	BL2.5X15A	15"(381mm)	2-1/2"(64mm)	3"(76mm)	3"(76mm)	1-7/8"(48mm)	5-7/8"(149mm)
Ashley	BL3X20A	20"(508mm)	2-1/2"(64mm)	2-1/2"(64mm)	2-1/2"(64mm)	1-1/2"(38mm)	5-3/8"(137mm)
	BL3X24A	24"(610mm)	2-1/2"(64mm)	4-1/2"(114mm)	4-1/2"(114mm)	1-3/8"(35mm)	5-3/8"(137mm)
	BL3X28A	28"(711mm)	2-1/2"(64mm)	4-1/2"(114mm)	4-1/2"(114mm)	1-3/8"(35mm)	5-3/8"(137mm)
	BL3X32A	32"(813mm)	2-1/2"(64mm)	4-1/2"(114mm)	4-1/2"(114mm)	1-3/8"(35mm)	5-3/8"(137mm)
	BL3X36A	36"(914mm)	2-1/2"(64mm)	6"(152mm)	6"(152mm)	1-1/2"(32mm)	5-3/8"(137mm)
Woodruff	BL3X18W	18"(457mm)	2-1/2"(64mm)	4"(102mm)	4"(102mm)	1-3/8"(35mm)	5-1/2"(140mm)
	BL3X20W	20"(508mm)	2-1/2"(64mm)	4"(102mm)	4"(102mm)	1-1/2"(32mm)	5-1/4"(133mm)
	BL3X24W	24"(610mm)	2-1/2"(64mm)	4"(102mm)	4"(102mm)	1-1/2"(32mm)	5-1/8"(130mm)
	BL3X28W	28"(711mm)	2-1/2"(64mm)	4"(102mm)	4"(102mm)	1-1/2"(32mm)	5-1/8"(130mm)
	BL3X32W	32"(813mm)	2-1/2"(64mm)	4"(102mm)	4"(102mm)	1-1/2"(32mm)	5-1/8"(130mm)
	BL3X36W	36"(914mm)	2-1/2"(64mm)	4"(102mm)	4"(102mm)	1-1/2"(38mm)	5-1/8"(130mm)
Classic	BL3X20C	20"(508mm)	2-1/2"(64mm)	3-1/2"(89mm)	3-1/2"(89mm)	1-1/8"(29mm)	5"(127mm)
	BL3X24C	24"(610mm)	2-1/2"(64mm)	3-1/2"(89mm)	3-1/2"(89mm)	1-1/8"(29mm)	5"(127mm)
	BL3X28C	28"(711mm)	2-1/2"(64mm)	3-1/2"(89mm)	3-1/2"(89mm)	1"(25mm)	5"(127mm)
	BL3X32C	32"(813mm)	2-1/2"(64mm)	3-1/2"(89mm)	3-1/2"(89mm)	1-1/8"(29mm)	5-1/8"(130mm)

7" BALUSTRADE SYSTEM



Top Straight Rails

	Part#	Top Width (A)	Bottom Width (B)	Height (C)	Length
	TR7X96				96" (2438mm)
	TR7X120	7" (178mm)	5-½" (140mm)	5-½" (133mm)	120" (3048mm)
	TR7X144				144" (3658mm)

Bottom Straight Rails

	Part#	Top Width (A)	Bottom Width (B)	Height (C)	Length
	BR7X96				96" (2438mm)
	BR7X120	5-½" (140mm)	7" (178mm)	5-½" (133mm)	120" (3048mm)
	BR7X144				144" (3658mm)

Rail Support Block

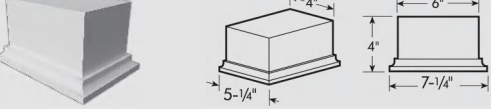
	Part#	Top Width	Top Length	Height	Coordinate
	RS2X4X6	2" (51mm)	6" (152mm)	4" (102mm)	Rail 5"/7"
	RS4X4X6	4" (102mm)	6" (152mm)	4" (152mm)	

Balustrade Rail Installation Kits

Part#	Kit Contents	Installation Notes
 BRK6-7	(2) Angle Brackets & Mounting Hardware (8) White flat screws	Connects both ends of one 7" top or bottom rail to support structure. Order two kits per section.

7" BALUSTRADE SYSTEM

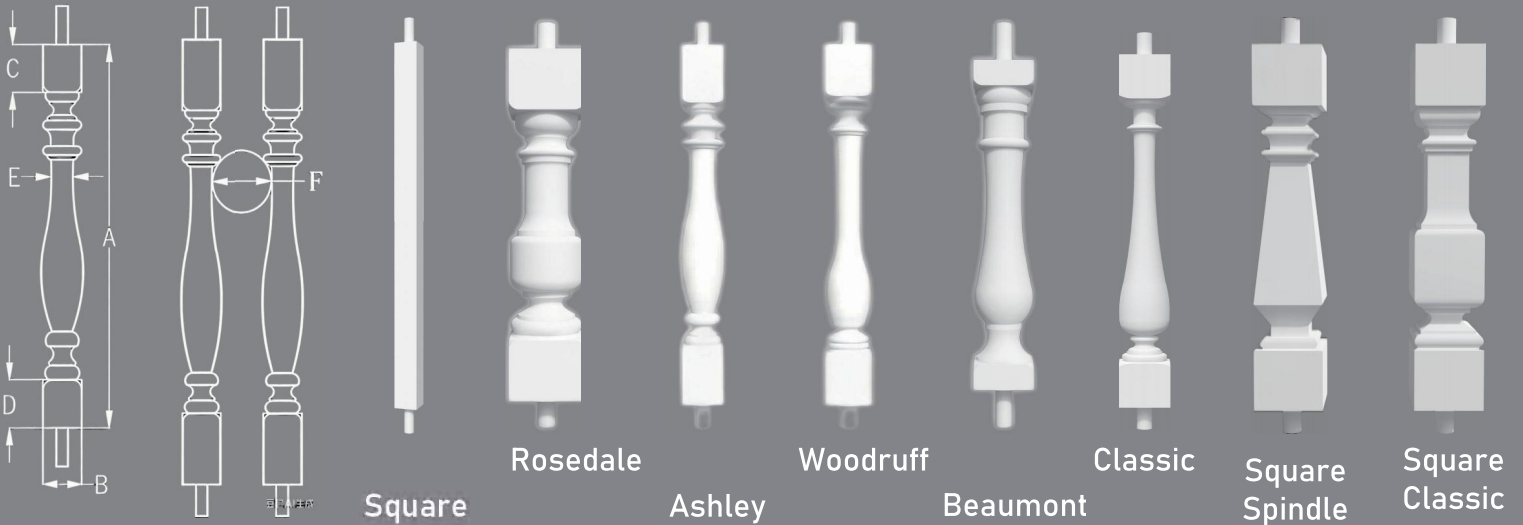

7"	Part#	A	B	C	D	E	F	
Square	BL5X28Q	28"(711mm)	4-7/8"(124mm)	-	-	-		
Rosedale	BL5X20R	20"(508mm)	4-1/2"(114mm)	4"(102mm)	4"(102mm)	2-3/8"(70mm)	6-5/8"(168mm)	
Ashley	BL4X24A	24"(610mm)	4-1/2"(114mm)	4-1/2"(114mm)	4-1/2"(114mm)	3-1/2"(89mm)	7-3/8"(187mm)	
	BL5X20A	20"(508mm)	4-1/2"(114mm)	3-1/2"(89mm)	3-1/2"(89mm)	3-1/2"(89mm)	7-3/8"(187mm)	
	BL5X24A	24"(610mm)	4-1/2"(114mm)	3-1/2"(89mm)	3-1/2"(89mm)	3-1/2"(89mm)	7-3/8"(187mm)	
	BL5X32A	32"(813mm)	4-1/2"(114mm)	4-1/2"(114mm)	4-1/2"(114mm)	3-3/8"(86mm)	7-3/8"(187mm)	
	BL5X20W	20"(508mm)	4-1/2"(114mm)	4"(102mm)	4"(102mm)	3-1/4"(83mm)	7-1/8"(181mm)	
Woodruff	BL5X24W	24"(610mm)	4-1/2"(114mm)	4"(102mm)	4"(102mm)	3-1/2"(89mm)	7-1/8"(181mm)	
	BL5X28W	28"(711mm)	4-1/2"(114mm)	4"(102mm)	4"(102mm)	3-1/2"(89mm)	7-1/8"(181mm)	
	BL5X32W	32"(813mm)	4-1/2"(114mm)	4"(102mm)	4"(102mm)	3-1/2"(89mm)	7-1/8"(181mm)	
	BL4X22B	22"(559mm)	4"(102mm)	1-1/8"(29mm)	1-3/8"(44mm)	2-3/8"(60mm)	6-1/4"(159mm)	
Beaumont	BL5X19B	19-1/8"(486mm)	5-1/4"(133mm)	1-1/8"(29mm)	1-3/8"(44mm)	2-3/8"(70mm)	6-3/4"(171mm)	
	BL5X22B	22"(559mm)	5"(127mm)	2-1/8"(54mm)	3-3/8"(95mm)	3-1/4"(83mm)	7-1/8"(181mm)	
	BL5X20C	20"(508mm)	5"(127mm)	5"(127mm)	5"(127mm)	3-5/8"(92mm)	7-5/8"(194mm)	
	BL5X24C	24"(610mm)	5"(127mm)	5"(127mm)	5"(127mm)	3-5/8"(92mm)	7-5/8"(194mm)	
Classic	BL5X28C	28"(711mm)	5"(127mm)	5"(127mm)	5"(127mm)	3-1/2"(89mm)	7-1/2"(191mm)	
	BL5X30C	30-1/2"(775mm)	5"(127mm)	5"(127mm)	5"(127mm)	3-5/8"(92mm)	7-1/2"(191mm)	
	BL5X32C	32"(813mm)	5"(127mm)	5"(127mm)	5"(127mm)	3-1/2"(89mm)	7-1/2"(191mm)	
	BL4X27CO	27"(686mm)	4-1/4"(108mm)	4"(102mm)	4"(102mm)	1-7/8"(48mm)	5-3/4"(146mm)	
	BL4X31CO	31"(787mm)	4-1/4"(108mm)	4"(102mm)	4"(102mm)	1-1/2"(38mm)	5-3/4"(146mm)	
	BL5X28CO	28"(711mm)	4-1/2"(114mm)	3-3/8"(86mm)	3-3/8"(86mm)	2"(51mm)	5-7/8"(149mm)	
	Square Spindle	BL5X24SF	24"(610mm)	4-1/2"(114mm)	4"(102mm)	4"(102mm)	2-7/16"(62mm)	5"(127mm)
	Square Classic	BL5X24CF	24"(610mm)	4-1/2"(114mm)	4"(102mm)	4"(102mm)	2-11/16"(69mm)	24"(610mm)

NEWEL POST



Plain Newel Post

Part#	Balustrade System	Width	Height
NP6X48	5"	5-½"(140mm)	48"(1219mm)
NP8X48	7"	7-½"(191mm)	48"(1219mm)



Corner Panel Newel Post

Part#	Balustrade System	Width	Height
NCP8X48	7"	8"(203mm)	48"(1219mm)



Straight Panel Newel Post



Part#	Balustrade System	Width	Height
NSP8X48	7"	8"(203mm)	48"(1219mm)

Newel Posts Installation Kits

	Part #	Kit Contents	Installation Notes (Use one kit per post)
	PK400	(1)Long Galv. Channel (1)Zinc Plated Threaded Rod (1)Galv. Mounting Plate (1)Lock Washer	Secures one 6" newel post to the structural substrate.
PK600	(1)Zinc Plated Hex Nut	Secures one 8" newel post to the structural substrate.	

POST ACCESSORIES

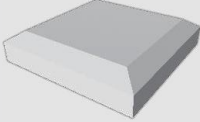
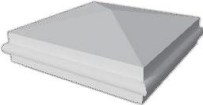
Post Accessories

	Part#	Top Width	Height	Coordinate
	NPT7X7	4-½"(114mm)	1-½"(38mm)	B5X7 NP6X48
	NPT10X10	6-½"(159mm)	2"(51mm)	NP8X48 NPCP8X48 NPSP8X48
	NPT6X6P	5-⅞"(149mm)	2-⅛"(54mm)	NP6X48
	NPT8X8P	8-⅛"(206mm)	3"(76mm)	NP8X48
	NPT9X9P	8-⅞"(225mm)	3"(76mm)	NPCP8X48 NPSP8X48
	NPT7X7P	6-½"(165mm)	1-½"(38mm)	NP6X48

Post Accessories

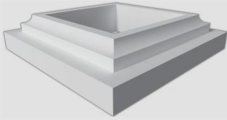
	Part#	Top Inside Width	Bottom Outside Width	Height	Coordinate
	T6C	5-⅝"(143mm)	9-⅛"(232mm)	2"(51mm)	NP6X48
	T8C	7-⅝"(194mm)	11-⅛"(283mm)	2"(51mm)	NP8X48
	T8-8C	8-⅛"(206mm)	11-⅛"(283mm)	2"(51mm)	NPCP8X48 NPSP8X48



POST ACCESSORIES



	Acorn	Pedestal Ball	Post Ball	Decorative Ball
Part#	AF10	B3X4	B3X5	B7X9
Overall Height	11-1/8" (283mm)	4-5/8" (117mm)	5-1/4" (133mm)	8-1/2" (216mm)
Ball Diameter	4-7/8" (124mm)	3-1/8" (79mm)	3-1/4" (83mm)	6-1/4" (159mm)
Base Diameter	4-1/2" (114mm)	3-1/4" (83mm)	3-1/4" (83mm)	6-1/2" (165mm)



Post Ball

Part#	B5X7	B6X8	B6X9	B8X10	B10X13	B12X16
Overall Height	6-3/4" (171mm)	7-3/4" (197mm)	9" (229mm)	10" (254mm)	12-7/8" (327mm)	16" (406mm)
Ball Diameter	5-1/2" (133mm)	5-7/8" (149mm)	7" (178mm)	8" (203mm)	10" (254mm)	12" (305mm)
Base Diameter	4-3/8" (111mm)	5-7/8" (149mm)	5-7/8" (149mm)	8-1/4" (210mm)	8-1/2" (216mm)	12" (305mm)



Pineapple

Part#	PAPE5X11	PAPE6X14
Overall Height	11" (279mm)	14" (356mm)
Ball Diameter	5-5/8" (143mm)	7-1/8" (181mm)
Base Diameter	4-3/4" (121mm)	6-1/8" (156mm)



Spires

Part#	S4X21	S6X32	S8X56
Overall Height	21-1/4" (540mm)	32-1/4" (819mm)	56" (1422mm)
Ball Diameter	7" (178mm)	6" (152mm)	8" (203mm)
Base Diameter	3-1/2" (89mm)	4-1/4" (108mm)	8" (203mm)

PORCH POSTS&COLUMNS

Colonial Porch Post

Part#	Balustrade System	Width (A)	Overall Height (B)	Bottom Block Height(C)	Load Bearing Capacity
PP6X96		5-½" (140mm)	96" (2438mm)	44-½" (1130mm)	
PP6X108	5"	5-½" (140mm)	108" (2743mm)	44-½" (1130mm)	2800KGS
PP6X120		5-½" (140mm)	120" (3048mm)	44-½" (1130mm)	

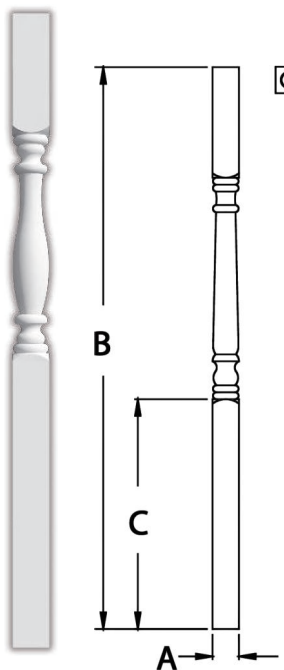

PP8X120A	7"	7-½" (191mm)	120" (3048mm)	42" (1067mm)	5500KGS
----------	----	-----------------	------------------	-----------------	---------

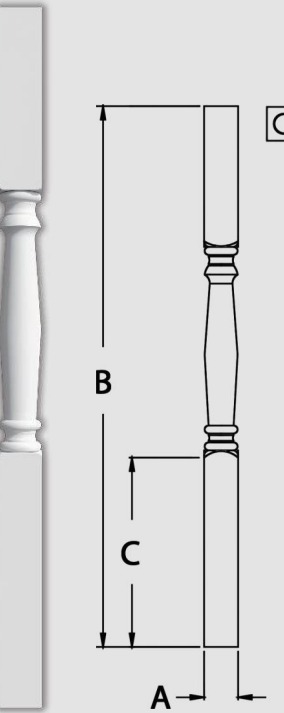

PORCH POSTS&COLUMNS

Panel Square Columns



Part#	Width	Base Width(A)	Height(B)	Load Bearing Capacity
SPCOL8X96	6" (152mm)	8" (203mm)	96" (2438mm)	5500KGS
SPCOL11X96	8" (203mm)	10-½" (267mm)	96" (2438mm)	
SPCOL11X108	8" (203mm)	10-½" (267mm)	108" (2743mm)	

Structural Woodgrain Column

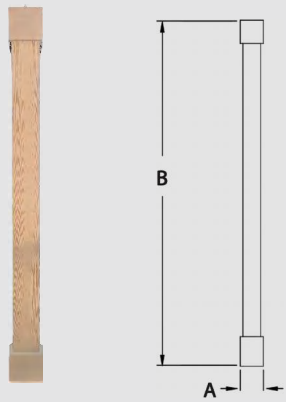

Part#	Width(A)	Height(B)	Load Bearing Capacity
SKPP6X96S	7" (178mm)	96" (2438mm)	5500KGS
SKPP6X108S	7" (178mm)	108" (2743mm)	
SKPP6X120S	7" (178mm)	120" (3048mm)	

Lamp Post

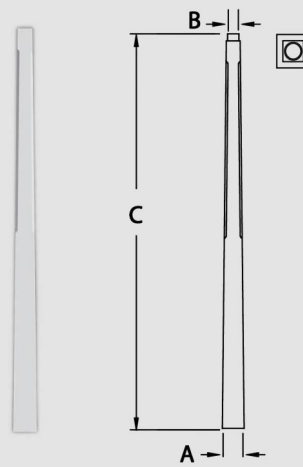

Part#	Bottom width(A)	Top Width(B)	Overall Height(C)
LP6X96	5-½" (140mm)	3-½" (89mm)	96" (2438mm)



COLUMN WRAP

COLUMN WRAP

How to Choose

1 Material&Texture



Smooth Plain PVC



Wood-Grained Polyurethane

2 Style

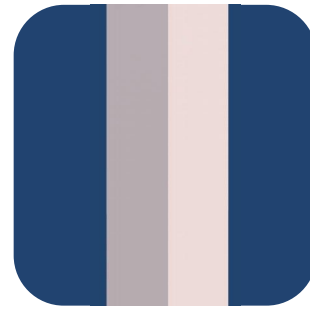

Square



Tapered

3 Assembled Mode



Semi-assembled Panel



Flat Panel

4 Panel Style



Flat Panel(FT)



Fluted(FL)



Raised Panel(RS)



Recessed Panel(RC)

5 Top & Base (See page 167&169)

COLUMN WRAP

Square Column Wrap Semi-Assembled PVC Flat Panel with Plain Top & Base

Part #	Nominal Shaft Width	Actual Shaft Width	Actual Inside Width	Height
CPVPS6X72FT				72"(1829mm)
CPVPS6X96FT				96"(2438mm)
CPVPS6X108FT	6"	5- ³ / ₈ " (146mm)	4" (102mm)	108"(2743mm)
CPVPS6X120FT				120"(3048mm)
CPVPS6X144FT				144"(3658mm)
CPVPS8X72FT				72"(1829mm)
CPVPS8X96FT				96"(2438mm)
CPVPS8X108FT	8"	7- ³ / ₈ " (197mm)	4- ⁷ / ₈ " (124mm)	108"(2743mm)
CPVPS8X120FT				120"(3048mm)
CPVPS8X144FT				144"(3658mm)
CPVPS10X72FT				72"(1829mm)
CPVPS10X96FT				96"(2438mm)
CPVPS10X108FT	10"	9- ³ / ₈ " (248mm)	6- ⁷ / ₈ " (175mm)	108"(2743mm)
CPVPS10X120FT				120"(3048mm)
CPVPS10X144FT				144"(3658mm)
CPVPS12X72FT				72"(1829mm)
CPVPS12X96FT				96"(2438mm)
CPVPS12X108FT	12"	11- ³ / ₈ "(298mm)	8- ⁷ / ₈ "(225mm)	108"(2743mm)
CPVPS12X120FT				120"(3048mm)
CPVPS12X144FT				144"(3658mm)

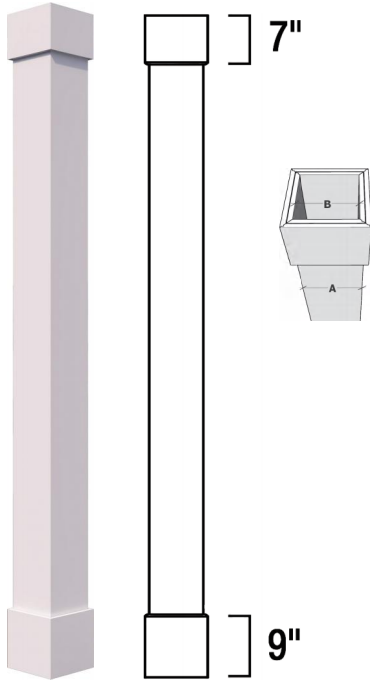

Square Column Wrap Assembled PVC Flat Panel (Top&Base ordered Separately)

Part #	Nominal Shaft Width	Actual Shaft Width	Actual Inside Width	Height
CPVPSFP6X6X96FT				96" (2438mm)
	6"	5- ³ / ₈ " (146mm)	4" (102mm)	
CPVPSFP6X6X108FT				108" (2743mm)

*Accessories are sold separately .

COLUMN WRAP

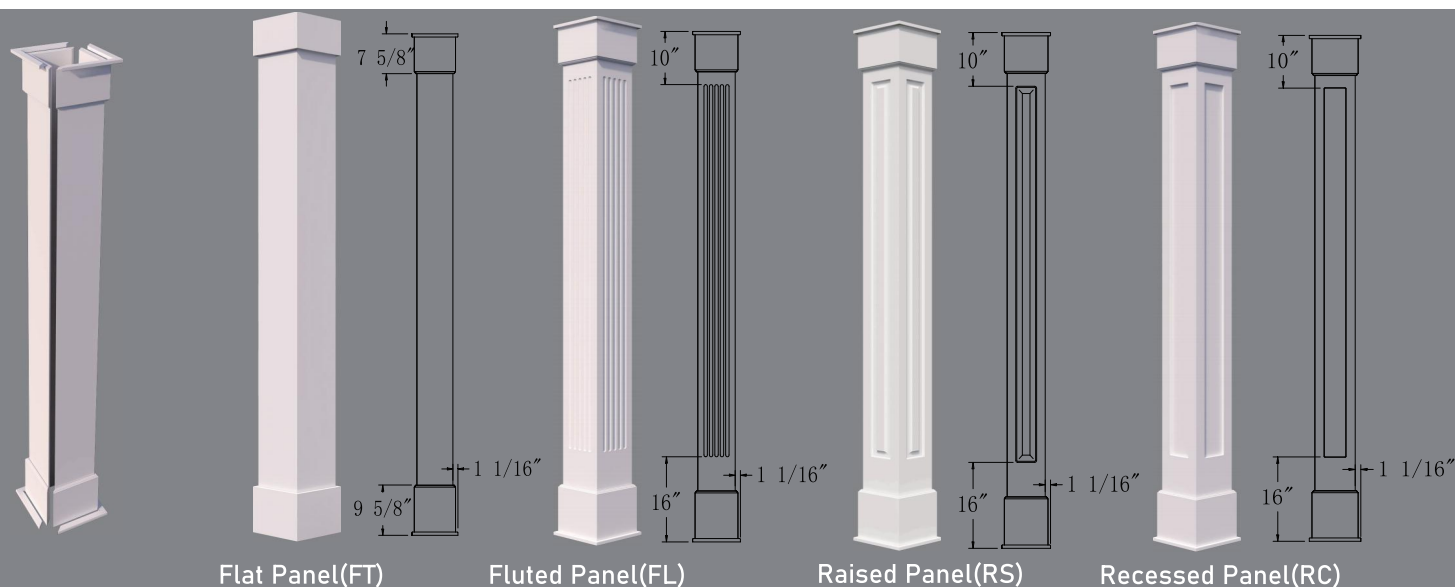

Square Column Wrap Semi-Assembled PVC Panel with Traditional Top & Base

Flat Panel(FT)	Fluted Panel(FL)	Raised Panel(RS)	Recessed Panel(RC)	Nominal Shaft Width	Actual Shaft Width	Actual Inside Width	Height
CPVPM6X72FT	--	--	--	6	5- ³ / ₄ " (146mm)	4- ³ / ₄ " (121mm)	72"(1829mm)
CPVPM6X96FT	--	--	--				96"(2438mm)
CPVPM6X108FT	--	--	--				108"(2743mm)
CPVPM6X120FT	--	--	--				120"(3048mm)
CPVPM6X144FT	--	--	--				144"(3658mm)
CPVPM8X72FT	CPVPM8X120FL	CPVPM8X72RS	CPVPM8X72RC	8"	7- ³ / ₄ " (197mm)	6- ³ / ₄ " (171mm)*	72"(1829mm)
CPVPM8X96FT	CPVPM8X144FL	CPVPM8X96RS	CPVPM8X96RC				96"(2438mm)
CPVPM8X108FT	CPVPM8X72FL	CPVPM8X108RS	CPVPM8X108RC				108"(2743mm)
CPVPM8X120FT	CPVPM8X96FL	CPVPM8X120RS	CPVPM8X120RC				120"(3048mm)
CPVPM8X144FT	CPVPM8X108FL	CPVPM8X144RS	CPVPM8X144RC				144"(3658mm)
CPVPM10X72FT	CPVPM10X72FL	CPVPM10X72RS	CPVPM10X72RC	10"	9- ³ / ₄ " (248mm)	8- ³ / ₄ " (222mm)*	72"(1829mm)
CPVPM10X96FT	CPVPM10X96FL	CPVPM10X96RS	CPVPM10X96RC				96"(2438mm)
CPVPM10X108FT	CPVPM10X108FL	CPVPM10X108RS	CPVPM10X108RC				108"(2743mm)
CPVPM10X120FT	CPVPM10X120FL	CPVPM10X120RS	CPVPM10X120RC				120"(3048mm)
CPVPM10X144FT	CPVPM10X144FL	CPVPM10X144RS	CPVPM10X144RC				144"(3658mm)
CPVPM12X72FT	CPVPM12X72FL	CPVPM12X72RS	CPVPM12X72RC	12"	11- ³ / ₄ " (298mm)	10- ³ / ₄ " (273mm)*	72"(1829mm)
CPVPM12X96FT	CPVPM12X96FL	CPVPM12X96RS	CPVPM12X96RC				96"(2438mm)
CPVPM12X108FT	CPVPM12X108FL	CPVPM12X108RS	CPVPM12X108RC				108"(2743mm)
CPVPM12X120FT	CPVPM12X120FL	CPVPM12X120RS	CPVPM12X120RC				120"(3048mm)
CPVPM12X144FT	CPVPM12X144FL	CPVPM12X144RS	CPVPM12X144RC				144"(3658mm)

*Actual Inside Width reduce 1"(25mm) for Recessed Panel

COLUMN WRAP

Square Column Wrap

Assembled PVC Flat Panel (Top & Base ordered Separately)

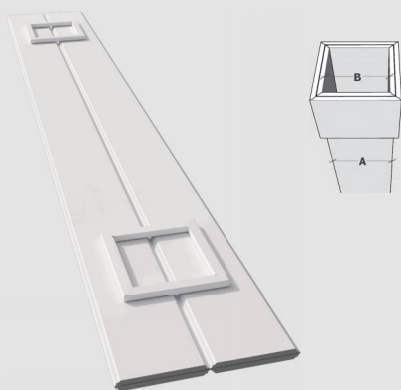







Flat Panel(FT)	Normal Shaft Width	Actual Shaft Width(A)	Actual Inside Width(B)	Height
CPVPMFP6X96FT				96"(2438mm)
CPVPMFP6X108FT	6"	5- ³ / ₄ " (146mm)	4- ³ / ₄ " (121mm)	108"(2743mm)
CPVPMFP6X120FT				120"(3048mm)
CPVPMFP8X96FT				96"(2438mm)
CPVPMFP8X108FT	8"	7- ³ / ₄ " (197mm)	6- ³ / ₄ " (171mm)	108"(2743mm)
CPVPMFP8X120FT				120"(3048mm)
CPVPMFP10X96FT				96"(2438mm)
CPVPMFP10X108FT	10"	9- ³ / ₄ " (248mm)	8- ³ / ₄ " (222mm)	108"(2743mm)
CPVPMFP10X120FT				120"(3048mm)

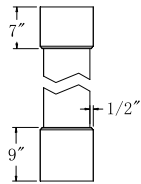
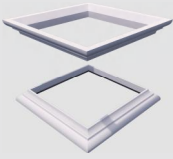
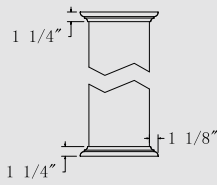

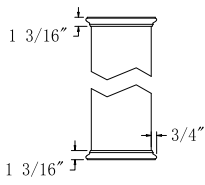
COLUMN WRAP ACCESSORIES

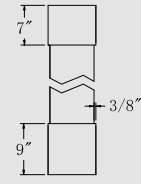
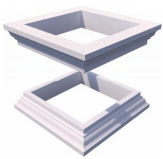
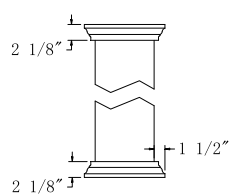
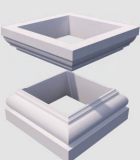
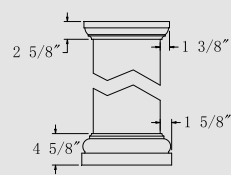
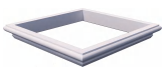
Top & Base Accessories for Straight Column Wrap

Style	Top & Base	Dimensions	Material	6"X6"	8"X8"	10"X10"	12"X12"
Traditional			PVC	CPCB6TR	CPCB8TR	CPCB10TR	CPCB12TR
Craftsman			PVC	CPCB6CF	CPCB8CF	CPCB10CF	CPCB12CF
Greek			PVC	CPCB6GK	CPCB8GK	CPCB10GK	CPCB12GK
Plain			PVC	CPCB6PL	CPCB8PL	CPCB10PL	CPCB12PL
Roman			PVC	CPCB6RO	CPCB8RO	CPCB10RO	CPCB12RO
Tuscan			PU	CPCB6TS	CPCB8TS	CPCB10TS	CPCB12TS
Neck Mould			PVC	CP6NM	CP8NM	CP10NM	CP12NM

COLUMN WRAP

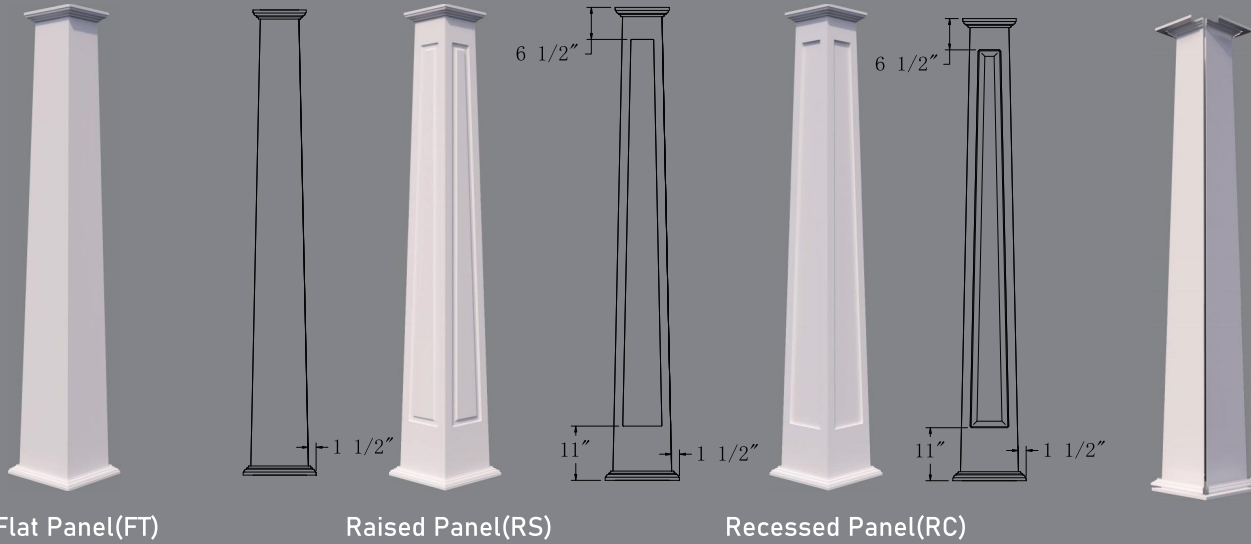

Tapered Column Wrap Assembled PVC Shaft with Craftsman Top & Base



Flat Panel(FT)	Raised Panel(RS)	Recessed Panel(RC)	Normal Shaft Width	Actual Shaft Width	Height
CPVPM8X12X48FT	CPVPM8X12X48RS	CPVPM8X12X48RC	Top: 8" Base: 12"	Top:7- ³ / ₄ " (197mm) Base:11- ³ / ₄ " (298mm)	48"(1219mm)
CPVPM8X12X54FT	CPVPM8X12X54RS	CPVPM8X12X54RC			54"(1372mm)
CPVPM8X12X60FT	CPVPM8X12X60RS	CPVPM8X12X60RC			60"(1524mm)
CPVPM8X12X66FT	CPVPM8X12X66RS	CPVPM8X12X66RC			66"(1676mm)
CPVPM8X12X72FT	CPVPM8X12X72RS	CPVPM8X12X72RC			72"(1829mm)
CPVPM8X12X96FT	CPVPM8X12X96RS	CPVPM8X12X96RC			96"(2438mm)
CPVPM11X16X48FT	CPVPM11X16X48RS	CPVPM11X16X48RC	Top:11" Base:16"	Top:10- ³ / ₄ " (273mm) Base:15- ³ / ₄ " (400mm)	48"(1219mm)
CPVPM11X16X54FT	CPVPM11X16X54RS	CPVPM11X16X54RC			54"(1372mm)
CPVPM11X16X60FT	CPVPM11X16X60RS	CPVPM11X16X60RC			60"(1524mm)
CPVPM11X16X66FT	CPVPM11X16X66RS	CPVPM11X16X66RC			66"(1676mm)
CPVPM11X16X72FT	CPVPM11X16X72RS	CPVPM11X16X72RC			72"(1829mm)
CPVPM11X16X96FT	CPVPM11X16X96RS	CPVPM11X16X96RC			96"(2438mm)
CPVPM13X20X48FT	CPVPM13X20X48RS	CPVPM13X20X48RC	Top:13" Base:20"	Top:12- ³ / ₄ " (324mm) Base:19- ³ / ₄ " (502mm)	48"(1219mm)
CPVPM13X20X54FT	CPVPM13X20X54RS	CPVPM13X20X54RC			54"(1372mm)
CPVPM13X20X60FT	CPVPM13X20X60RS	CPVPM13X20X60RC			60"(1524mm)
CPVPM13X20X66FT	CPVPM13X20X66RS	CPVPM13X20X66RC			66"(1676mm)
CPVPM13X20X72FT	CPVPM13X20X72RS	CPVPM13X20X72RC			72"(1829mm)
CPVPM13X20X96FT	CPVPM13X20X96RS	CPVPM13X20X96RC			96"(2438mm)
CPVPM16X24X48FT	CPVPM16X24X48RS	CPVPM16X24X48RC	Top:16" Base:24"	Top:15- ³ / ₄ " (400mm) Base:23- ³ / ₄ " (603mm)	48"(1219mm)
CPVPM16X24X54FT	CPVPM16X24X54RS	CPVPM16X24X54RC			54"(1372mm)
CPVPM16X24X60FT	CPVPM16X24X60RS	CPVPM16X24X60RC			60"(1524mm)
CPVPM16X24X66FT	CPVPM16X24X66RS	CPVPM16X24X66RC			66"(1676mm)
CPVPM16X24X72FT	CPVPM16X24X72RS	CPVPM16X24X72RC			72"(1829mm)
CPVPM16X24X96FT	CPVPM16X24X96RS	CPVPM16X24X96RC			96"(2438mm)

COLUMN WRAP

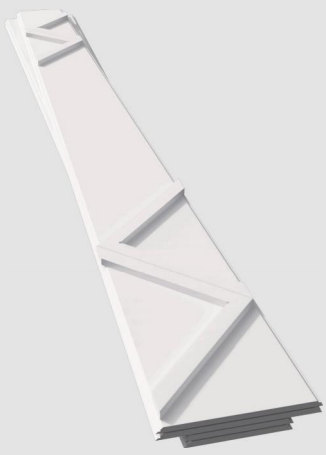
Tapered Column Wrap-Assembled PVC Flat Shaft (Top & Base ordered Separately)

	Flat Panel(FT)	Normal Shaft Width	Actual Shaft Width	Height
	CPVPMFP8X12X60FT			60"(1524mm)
	CPVPMFP8X12X66FT	Top:8"(203mm) Base:12"(305mm)	Top:7-3/4"(197mm) Base:11-3/4"(298mm)	66"(1676mm)
	CPVPMFP8X12X72FT			72"(1829mm)
	CPVPMFP11X16X60FT			60"(1524mm)
	CPVPMFP11X16X66FT	Top:11"(279mm) Base:16"(406mm)	Top:10-3/4"(273mm) Base:15-3/4"(400mm)	66"(1676mm)
	CPVPMFP11X16X72FT			72"(1829mm)

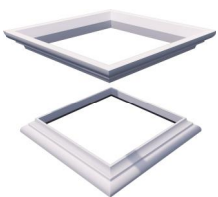
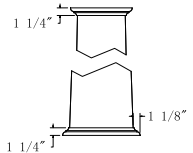
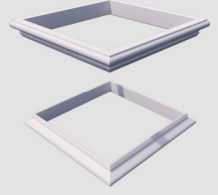
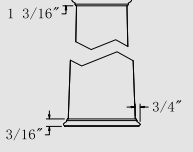
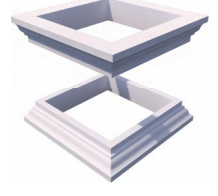
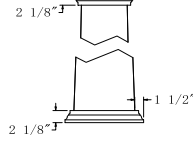
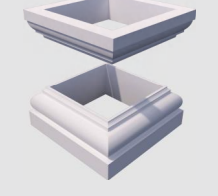
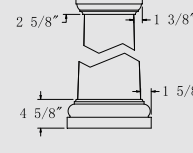
Top & Base Accessories for Tapered Column Wrap

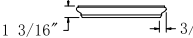
Style	Top & Base	Dimensions	Material	8"X12"	11"X16"	13"X20"	16"X24"
Craftman			PVC	CPCB8X12CF	CPCB11X16CF	CPCB13X20CF	CPCB16X24CF
Greek			PVC	CPCB8X12GK	CPCB11X16GK	CPCB13X20GK	CPCB16X24GK
Roman			PVC	CPCB8X12RO	CPCB11X16RO	CPCB13X20RO	CPCB16X24RO
Tuscan			PU	CPCB8X12TS	CPCB11X16TS	CPCB13X20TS	CPCB16X24TS
Neck Mould			PVC	CP17NM			



PUR COLUMN WRAP

Square Woodgrain Column Wrap Assembled PUR Panel with Standard Top & Base



Flat Panel(FT)	Nominal Shaft Width	Actual Shaft Width	Actual Inside Width	Height
CPUFP6X96FT				96"(2438mm)
CPUFP6X108FT	6"	5- $\frac{3}{4}$ " (146mm)	4- $\frac{1}{2}$ " (108mm)	108"(2743mm)
CPUFP6X120FT				120"(3048mm)
CPUFP8X96FT				96"(2438mm)
CPUFP8X108FT	8"	7- $\frac{3}{4}$ " (197mm)	6- $\frac{1}{2}$ " (159mm)	108"(2743mm)
CPUFP8X120FT				120"(3048mm)
CPUFP10X96FT				96"(2438mm)
CPUFP10X108FT	10"	9- $\frac{3}{4}$ " (248mm)	8- $\frac{1}{2}$ " (210mm)	108"(2743mm)
CPUFP10X120FT				120"(3048mm)
CPUFP12X96FT				96"(2438mm)
CPUFP12X108FT	12"	11- $\frac{3}{4}$ " (298mm)	10- $\frac{1}{2}$ " (260mm)	108"(2743mm)
CPUFP12X120FT				120"(3048mm)

**Length can also assemble PVC&PUR Column Wrap with multiple Woodgrain PUR boards or plain PVC boards according to customer needs ,ANY SIZE actual width from 5- $\frac{3}{4}$ "(146mm) to 23- $\frac{3}{4}$ "(603mm),actual Height from 48"(1219mm)to 144"(3658mm).Flexible processing to meet various needs.*

PUR COLUMN WRAP

Tapered Woodgrain Column Wrap Assembled PUR Panel with Standard Top & Base

	Flat Panel(FT)	Nominal Shaft Width	Actual Shaft Width	Height
	CPUFP8X12X48FT			
CPUFP8X12X54FT				54"(1372mm)
CPUFP8X12X60FT		TOP:8"	Top:7-3/4" (197mm)	60"(1524mm)
CPUFP8X12X66FT		BASE:12"	Base:11-3/4" (298mm)	66"(1676mm)
CPUFP8X12X72FT				72"(1829mm)
CPUFP8X12X96FT				96"(2438mm)
CPUFP11X16X48FT				48"(1219mm)
CPUFP11X16X54FT				54"(1372mm)
CPUFP11X16X60FT		Top:11"	Top:10-3/4" (273mm)	60"(1524mm)
CPUFP11X16X66FT		Base:16"	Base:15-3/4" (400mm)	66"(1676mm)
CPUFP11X16X72FT				72"(1829mm)
CPUFP11X16X96FT				96"(2438mm)

Accessories

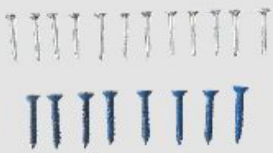
Part #	Description	Qty	Remark	
	CPINSTALLKIT	Adhesive	1	Ordered Separately
	CPINSTALLKIT-1	1-1/4"(32mm) Flat head concrete screw(Blue coating)	8	Ship with Column Wrap
		1-1/4"(32mm) Flat head screws	12	



PUR COLUMN BASE

Column Wrap Accessories-Stone Column Base

Part#	Nominal Shaft Base Width	Actual Shaft Base Width	Column Base Width(A)	Column Base Height(H)
CPBPS16X16X16				16" (406mm)
CPBPS16X16X24	12"	11-3/4" (298mm)	16" (406mm)	24" (610mm)
CPBPS16X16X32				32" (813mm)
CPBPS20X20X24				24" (610mm)
CPBPS20X20X32	16"	15-3/4" (400mm)	20" (508mm)	32" (813mm)
CPBPS20X20X36				36" (914mm)

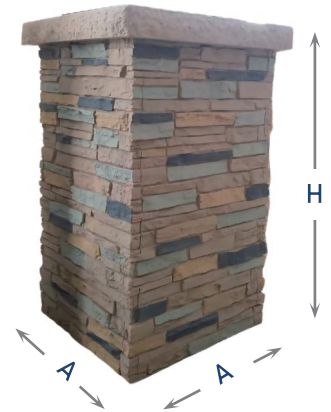

How to use it!

* Fast installation, flexible collocation, Legen combined column bases can meet your various needs.

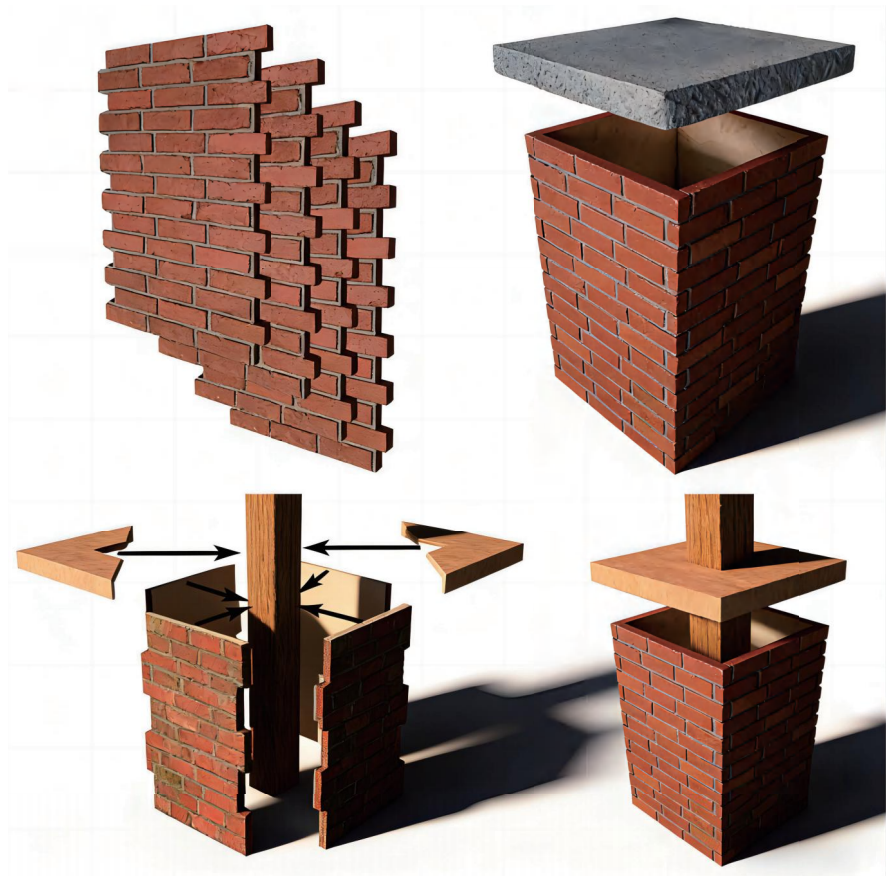

PUR COLUMN BASE

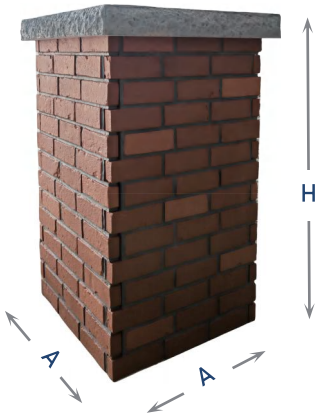

Column Wrap Accessories-Brick Column Base

Part#	Nominal Shaft Base Width	Actual Shaft Base Width	Column base Width(A)	Column base Height(H)
CPBPB16X16X16				16"(406mm)
CPBPB16X16X24	12"	11-3/4" (298mm)	16" (406mm)	24"(610mm)
CPBPB16X16X32				32"(813mm)
CPBPB20X20X24				24"(610mm)
CPBPB20X20X32	16"	15-3/4" (400mm)	20" (508mm)	32"(813mm)
CPBPB20X20X36				36"(914mm)





WOODGRAIN SIDING

WOODGRAIN SIDING









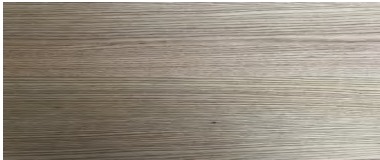

Woodgrain Siding



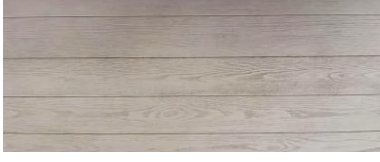

Part#	Projection	Height	Length
FT9X4X216S	3-½" (89mm)	8-½" (216mm)	216" (5486mm)
FT30X228X1S	1" (25mm)	30" (762mm)	228" (5791mm)
FT110-12S	¾" (19mm)	5-½" (140mm)	144" (3658mm)
FT111-12S	1-½" (38mm)	5-½" (140mm)	144" (3658mm)
FT150-12S	1-½" (38mm)	3-½" (89mm)	144" (3658mm)
FT151-12S	¾" (19mm)	3-½" (89mm)	144" (3658mm)
FT173-12S	¾" (19mm)	11-½" (292mm)	144" (3658mm)
FT187-12S	¾" (19mm)	7-½" (191mm)	144" (3658mm)
FT192-12S	1-½" (38mm)	11-½" (292mm)	144" (3658mm)
FT197-12S	1-½" (38mm)	7-½" (191mm)	144" (3658mm)







WOORGRAIN SIDING

Siding	Part #	Texture	Width	Length	Projection	Siding Joint Mode
	FT0.75X6.75X94S	Oak	6-3/4" (170mm)	94-1/8" (2390mm)	3/4" (19mm)	A,B,C
	FT1X19.5X142S	Oak	19-3/4" (500mm)	141-3/4" (3600mm)	1" (25mm)	A,B,C
	FT0.75X6.75X98S	Pine	6-3/4" (170mm)	98" (2490mm)	3/4" (19mm)	A,B,C
	FT1X8X99S		8" (200mm)	98-7/16" (2500mm)	1" (25mm)	A,B,C
	FT0.75X8X142S	Pine	8" (200mm)	141-3/4" (3600mm)	3/4" (19mm)	A,B,C
	FT0.75X6.75X98LS	Lauan	6-3/4" (170mm)	98" (2490mm)	3/4" (19mm)	A,B,C
	FT0.75X7X79S	Lauan	6-15/16" (176mm)	78-3/4" (2000mm)	3/4" (19mm)	A,B,C
	FT0.5X24X118S	Pine	23-5/8" (600mm)	118-1/8" (3000mm)	1/2" (13mm)	A,B
	TL1X25X96	Tile	25-1/2" (640mm)	96" (2438mm)	1" (25mm)	D

WOODGRAIN SIDING

Siding	Part #	Texture	Width	Length	Projection	Siding Joint Mode
	FSP103X17	Fishscale Panel-Round	16-1/2" (413mm)	102-5/8" (2581mm)	3/4" (19mm)	B
	SDG0.75X18.5X50S	Pine	18-3/8" (467mm)	50-3/8" (1280mm)	3/4" (19mm)	B
	SDG0.75X14X48S	Vertical grain	14-1/8" (359mm)	48-1/4" (1226mm)	3/4" (19mm)	B
	MD2.4X2.4X102S-IC	Pine	2-3/8" (60mm)	101-1/8" (2569mm)	2-3/8" (60mm)	-
	MD2.4X2.4X102S-OC	Pine	2-3/8" (60mm)	101-1/8" (2569mm)	2-3/8" (60mm)	-

Siding Joint Mode

Butted Joint(A) (Suitable for all thicknesses)	LAP Joint(B) (Recommended Above 1/2" Thickness)	Half-blind Lap Joint(C) (Recommended Above 3/4" Thickness)	Withholding Joint(D) (Tile Siding)
			



PREMIUM ADHESIVE

	Part#	Description
	RF-C0640	10.5 OZ Cartridge

Premium Adhesive Comparison---Why it's important to use the correct adhesive.

ADHESIVE BASE	URETHANE BASE PLPREMIUM ADHESIVE	SOLVENT BASE CONSTRUCTION ADHESIVE	WATER BASE CONSTRUCTION ADHESIVE
Exceeds VOC Compliance Regulations	YES	NO	YES
Environmentally safest grade	A	F	D+
Exceeds all treated, subfloor specs. & Building Codes	YES	NO	NO
Compatible with all building materials	YES	NO	NO
Special storage	NO	NO	YES
Workability below freezing	EXCELLENT	FAIR-POOR	NOT POSSIBLE
Permanent overnight bond	YES	NO	NO
Flammability	250° FLASHPOINT	0° EXTREMES FLAMMABLE; VAPORS MAY CAUSE FLASH FIRES	110°
High heat resistance(cured)	400°	190° MAXIMUM	180° MAXIMUM
Vapor toxicity	NONE	USE ONLY WITH CROSS VENTILATION	USE ONLY WITH CROSS VENTILATION
Repositioning up to one hour without losing strength	YES	NO	NO
Shrinkage	NIL	35-40%	35-40%
Workable yield of adhesive per 10.6 oz. tube to pass Building Codes	32 FT.	14 FT.	14 FT.
Chemical resistance	EXCELLENT	FAIR	FAIR
SHEAR STRENGTH*	24 HRS/7 DAYS	24 HRS/7 DAYS	24 HRS/7 DAYS
Polyurethane foam to brick	37 LBS. / 37 LBS.	12 LBS. / 37 LBS.	18 LBS. / 21 LBS.
Polyurethane foam to cinder block	37 LBS. / 37 LBS.	12 LBS. / 37 LBS.	18 LBS. / 21 LBS.
Polyurethane foam to concrete	37 LBS. / 37 LBS.	12 LBS. / 37 LBS.	18 LBS. / 21 LBS.
Polyurethane foam to Douglas fir	37 LBS. / 37 LBS.	12 LBS. / 37 LBS.	18 LBS. / 21 LBS.
Polyurethane foam to metal	37 LBS. / 37 LBS.	12 LBS. / 37 LBS.	18 LBS. / 21 LBS.
Polyurethane foam to Oriented Strandboard(OSB)	37 LBS. / 37 LBS.	12 LBS. / 37 LBS.	18 LBS. / 21 LBS.
Polyurethane foam to stucco	37 LBS. / 37 LBS.	12 LBS. / 37 LBS.	18 LBS. / 21 LBS.
Polyurethane foam to treated lumber	37 LBS. / 37 LBS.	12 LBS. / 37 LBS.	18 LBS. / 21 LBS.



INDEX

Part#	Page	Description	Part#	Page	Description
A5X10	129	ACORN-HALF ROUND, SMOOTH	BCD11X13X6S	114	CORBEL, TIMBER TEXTURE
A5X12	129	ACORN-HALF ROUND, SMOOTH	BCD11X15	106	BRACKET SMOOTH
A7X15	129	ACORN-HALF ROUND, SMOOTH	BCD11X16	106	BRACKET SMOOTH
AF10	159	FINIAL ACORN FULL ROUND SMOOTH	BCD11X16X6	107	BRACKET SMOOTH
AF24X4	26	TRIM HALF ROUND ARCH FLAT SMOOTH	BCD11X17	107	BRACKET SMOOTH
AF36X4	26	TRIM HALF ROUND ARCH FLAT SMOOTH	BCD11X20	107	BRACKET SMOOTH
AF36X6	26	TRIM HALF ROUND ARCH FLAT SMOOTH	BCD11X20X6	107	BRACKET SMOOTH
AF37X4	26	TRIM HALF ROUND ARCH FLAT SMOOTH	BCD11X20X8	107	BRACKET SMOOTH
AF48X4	26	TRIM HALF ROUND ARCH FLAT SMOOTH	BCD11X30	107	BRACKET SMOOTH
AF48X6	26	TRIM HALF ROUND ARCH FLAT SMOOTH	BCD12X10	107	BRACKET SMOOTH
AF72X4	26	TRIM HALF ROUND ARCH FLAT SMOOTH	BCD12X12	107	BRACKET SMOOTH
AM36X10L108	26	TRIM HALF RND ARCH DECO W/FLANK SMOOTH	BCD12X12GP	107	BRACKET SMOOTH
AM36X10SK	25	PEDIMENT HALF RND SNBST W/T & KEY SMOOTH	BCD12X12WW	107	BRACKET SMOOTH
AM36X4	26	TRIM HALF ROUND ARCH DECORATIVE SMOOTH	BCD12X12X3	107	BRACKET SMOOTH
AM36X6	26	TRIM HALF ROUND ARCH DECORATIVE SMOOTH	BCD12X12X4	107	BRACKET SMOOTH
AM40X54PSK	25	PEDIMENT HALF RND SNBST W/T & KEY SMOOTH	BCD12X16	108	BRACKET SMOOTH
AM40X6	26	TRIM HALF ROUND ARCH DECORATIVE SMOOTH	BCD12X17	108	BRACKET SMOOTH
AM48X4	26	TRIM HALF ROUND ARCH DECORATIVE SMOOTH	BCD12X18X3X1S	114	BRACKET, TIMBER TEXTURE
AM48X6	26	TRIM HALF ROUND ARCH DECORATIVE SMOOTH	BCD12X20X3S	114	BRACKET, TIMBER TEXTURE
AM60X6	26	TRIM HALF ROUND ARCH DECORATIVE SMOOTH	BCD12X21X3	108	BRACKET SMOOTH
AM72X6	26	TRIM HALF ROUND ARCH DECORATIVE SMOOTH	BCD12X24X3	108	BRACKET SMOOTH
AMC36X10	26	TRIM HALF RND ARCH DECO W/END CAP SMOOTH	BCD12X24X3S	114	BRACKET, TIMBER TEXTURE
AMC64X10	26	TRIM HALF RND ARCH DECO W/END CAP SMOOTH	BCD13X13X3	109	BRACKET SMOOTH
AP115	23	PEDIMENT ACORN ADJ SMOOTH	BCD13X15	109	BRACKET SMOOTH
AP56	23	PEDIMENT ACORN SMOOTH	BCD13X18X8S	114	BRACKET, TIMBER TEXTURE
AP61	23	PEDIMENT ACORN SMOOTH	BCD13X6	108	BRACKET SMOOTH
AP667	23	PEDIMENT ACORN SMOOTH	BCD14X12X6S	115	CORBEL, TIMBER TEXTURE
AP86	23	PEDIMENT ACORN SMOOTH	BCD14X14	109	BRACKET SMOOTH
AP91	23	PEDIMENT ACORN SMOOTH	BCD14X15	109	BRACKET SMOOTH
AP98	23	PEDIMENT ACORN SMOOTH	BCD14X16	109	BRACKET SMOOTH
B10X13	159	NEWEL POST BALL SMOOTH	BCD14X16X3.5S	114	BRACKET, TIMBER TEXTURE
B12X16	159	FINIAL BALL SMOOTH	BCD14X16X4	109	BRACKET SMOOTH
B3X4	159	FINIAL BALL SMOOTH	BCD14X16X6S	117	BRACKET, TIMBER TEXTURE
B3X5	159	FINIAL BALL SMOOTH	BCD14X26	107	BRACKET SMOOTH
B5X7	159	NEWEL POST BALL SMOOTH	BCD14X30X7.5S	114	BRACKET, TIMBER TEXTURE
B6X8	159	FINIAL BALL SMOOTH	BCD15X15	109	BRACKET SMOOTH
B6X9	159	FINIAL BALL SMOOTH	BCD15X18X6	109	BRACKET SMOOTH
B7X9	159	FINIAL BALL SMOOTH	BCD15X28	109	BRACKET SMOOTH
B8X10	159	FINIAL BALL SMOOTH	BCD16X16	109	BRACKET SMOOTH
BC10X10	147	BEAM END CAP	BCD16X18X3	109	BRACKET SMOOTH
BC10X12	147	BEAM END CAP	BCD16X18X4S	114	BRACKET, TIMBER TEXTURE
BC4X4	147	BEAM END CAP	BCD16X23X3	110	BRACKET SMOOTH
BC4X6	147	BEAM END CAP	BCD16X32X4S	114	BRACKET, TIMBER TEXTURE
BC6X6	147	BEAM END CAP	BCD16X7X3S	115	CORBEL, TIMBER TEXTURE
BC6X8	147	BEAM END CAP	BCD16X8S	115	CORBEL, TIMBER TEXTURE
BC8X10	147	BEAM END CAP	BCD16X9	109	BRACKET SMOOTH
BC8X8	147	BEAM END CAP	BCD17X17	110	BRACKET SMOOTH
BCD10X10X9	106	BRACKET SMOOTH	BCD18X10	110	BRACKET SMOOTH
BCD10X11	106	BRACKET SMOOTH	BCD18X18X3X1S	114	BRACKET, TIMBER TEXTURE
BCD10X12	106	BRACKET SMOOTH	BCD18X18X4	110	BRACKET SMOOTH
BCD10X12X4	106	BRACKET SMOOTH	BCD18X24	110	BRACKET SMOOTH
BCD10X14	106	BRACKET SMOOTH	BCD18X24X3	110	BRACKET SMOOTH
BCD10X16	106	BRACKET SMOOTH	BCD18X24X3X2S	114	BRACKET, TIMBER TEXTURE
BCD10X16X4	106	BRACKET SMOOTH	BCD18X24X4	110	BRACKET SMOOTH
BCD11X11X5S	116	CORBEL, TIMBER TEXTURE	BCD18X30X4	110	BRACKET SMOOTH
BCD11X12X3	106	BRACKET SMOOTH	BCD18X35	110	BRACKET SMOOTH

INDEX

Part#	Page	Description	Part#	Page	Description
BCD18X8X6S	115	CORBEL, TIMBER TEXTURE	BCD4X6X6	101	DENTIL BLOCK SMOOTH
BCD18X9X3	110	BRACKET SMOOTH	BCD4X6X7	102	DENTIL BLOCK SMOOTH
BCD18X9X3S	115	CORBEL, TIMBER TEXTURE	BCD4X6X9	102	DENTIL BLOCK SMOOTH
BCD19X20	110	BRACKET SMOOTH	BCD5X10	103	BRACKET SMOOTH
BCD19X24X4	110	BRACKET SMOOTH	BCD5X20	103	BRACKET SMOOTH
BCD19X31	111	BRACKET SMOOTH	BCD5X4	102	BRACKET SMOOTH
BCD19X36X4	111	BRACKET SMOOTH	BCD5X4X7	102	DENTIL BLOCK SMOOTH
BCD20X24X5	111	BRACKET SMOOTH	BCD5X5S	115	CORBEL, TIMBER TEXTURE
BCD20X30X6	111	BRACKET SMOOTH	BCD5X5X3	102	DENTIL BLOCK SMOOTH
BCD22X21	111	BRACKET SMOOTH	BCD5X5X3S	116	CORBEL, TIMBER TEXTURE
BCD22X22	111	BRACKET SMOOTH	BCD5X5X9	102	BRACKET SMOOTH
BCD22X24X4S	117	BRACKET, TIMBER TEXTURE	BCD5X6X10	102	DENTIL BLOCK SMOOTH
BCD22X24X6S	117	BRACKET, TIMBER TEXTURE	BCD5X6X11	102	DENTIL BLOCK SMOOTH
BCD22X26	111	BRACKET SMOOTH	BCD5X6X18	103	DENTIL BLOCK SMOOTH
BCD22X30	111	BRACKET SMOOTH	BCD5X6X6	102	DENTIL BLOCK SMOOTH
BCD22X30X6S	115	BRACKET, TIMBER TEXTURE	BCD5X6X8	102	DENTIL BLOCK SMOOTH
BCD22X30X8S	114	BRACKET, TIMBER TEXTURE	BCD5X8	103	DENTIL BLOCK SMOOTH
BCD23X26	111	BRACKET SMOOTH	BCD5X8X10	103	DENTIL BLOCK SMOOTH
BCD24X18X4S	115	BRACKET, TIMBER TEXTURE	BCD5X8X6	103	BRACKET SMOOTH
BCD24X24X12	111	BRACKET SMOOTH	BCD6X24	104	BRACKET SMOOTH
BCD24X24X5	111	BRACKET SMOOTH	BCD6X24X6	104	BRACKET SMOOTH
BCD24X36	111	BRACKET SMOOTH	BCD6X4X6	103	DENTIL BLOCK SMOOTH
BCD24X5X5S	115	CORBEL, TIMBER TEXTURE	BCD6X4X6L12	103	DENTIL BLOCK SMOOTH
BCD24X8X4S	115	CORBEL, TIMBER TEXTURE	BCD6X4X6R12	103	DENTIL BLOCK SMOOTH
BCD24X8X6S	115	CORBEL, TIMBER TEXTURE	BCD6X5X7	103	DENTIL BLOCK SMOOTH
BCD25X25	112	BRACKET SMOOTH	BCD6X6X5	103	DENTIL BLOCK SMOOTH
BCD25X27	112	BRACKET SMOOTH	BCD6X6X8	103	DENTIL BLOCK SMOOTH
BCD26X24X6S	117	BRACKET, TIMBER TEXTURE	BCD6X6X9	104	DENTIL BLOCK SMOOTH
BCD26X28	112	BRACKET SMOOTH	BCD6X6X9.25	104	DENTIL BLOCK SMOOTH
BCD28X30	112	BRACKET SMOOTH	BCD6X7X9	104	DENTIL BLOCK SMOOTH
BCD2X10	101	BRACKET SMOOTH	BCD6X8	104	BRACKET SMOOTH
BCD3.5X3.5X3.5	101	DENTIL BLOCK SMOOTH	BCD6X9X7	104	DENTIL BLOCK SMOOTH
BCD3.5X3.5X7	101	DENTIL BLOCK SMOOTH	BCD7X11S	116	CORBEL, TIMBER TEXTURE
BCD3.5X5.5X5.5	101	DENTIL BLOCK SMOOTH	BCD7X11X3	104	BRACKET SMOOTH
BCD30X30	112	BRACKET SMOOTH	BCD7X12X4	104	BRACKET SMOOTH
BCD30X30X8	112	BRACKET SMOOTH	BCD7X13X7S	116	CORBEL, TIMBER TEXTURE
BCD31X30X5	112	BRACKET SMOOTH	BCD7X15X4S	116	CORBEL, TIMBER TEXTURE
BCD32X31X5	112	TRELLIS OUTLOOKER SMOOTH	BCD7X16	104	BRACKET SMOOTH
BCD32X31X5S	115	BRACKET, TIMBER TEXTURE	BCD7X18	104	BRACKET SMOOTH
BCD32X32	112	BRACKET SMOOTH	BCD7X6X12	104	BRACKET SMOOTH
BCD36X36	112	BRACKET SMOOTH	BCD8X13	105	BRACKET SMOOTH
BCD36X36X4	112	BRACKET SMOOTH	BCD8X15	105	BRACKET SMOOTH
BCD36X36X6	112	BRACKET SMOOTH	BCD8X17	105	BRACKET SMOOTH
BCD36X42	112	BRACKET SMOOTH	BCD8X29X4	105	BRACKET SMOOTH
BCD39X10X5.5S	114	CORBEL, TIMBER TEXTURE	BCD8X6	105	BRACKET SMOOTH
BCD3X3X3	101	DENTIL BLOCK SMOOTH	BCD8X6X6	105	DENTIL BLOCK SMOOTH
BCD3X3X4	101	DENTIL BLOCK SMOOTH	BCD8X7X18	105	BRACKET SMOOTH
BCD3X5X6	101	DENTIL BLOCK SMOOTH	BCD8X8	105	BRACKET SMOOTH
BCD4.5X4X4	102	DENTIL BLOCK SMOOTH	BCD8X8X4	105	BRACKET SMOOTH
BCD40X40	112	BRACKET SMOOTH	BCD8X8X6S	116	CORBEL, TIMBER TEXTURE
BCD4X18X4	102	BRACKET SMOOTH	BCD8X9X14	105	BRACKET SMOOTH
BCD4X4X4	101	DENTIL BLOCK SMOOTH	BCD9X11	105	BRACKET SMOOTH
BCD4X4X7	101	DENTIL BLOCK SMOOTH	BCD9X11X16	106	DENTIL BLOCK SMOOTH
BCD4X4X9	101	DENTIL BLOCK SMOOTH	BCD9X13	106	BRACKET SMOOTH
BCD4X5X7	101	DENTIL BLOCK SMOOTH	BCD9X8X8	105	DENTIL BLOCK SMOOTH
BCD4X5X8	101	DENTIL BLOCK SMOOTH	BCDCV18X12X6S	117	CORBEL, TIMBER TEXTURE, COVE

INDEX

Part#	Page	Description	Part#	Page	Description
BCDCV18X24X4S	117	BRACKET, TIMBER TEXTURE, COVE KNEE BRACE	BL5X32C	156	BALUSTER CLASSIC SMOOTH
BCDCV18X24X6S	117	BRACKET, TIMBER TEXTURE, COVE KNEE BRACE	BL5X32W	156	BALUSTER WOODRUFF SMOOTH
BCDCV18X6X6S	117	CORBEL, TIMBER TEXTURE, COVE	BM10X10X288	132	BEAM SMOOTH
BCDCV18X8X4S	117	CORBEL, TIMBER TEXTURE, COVE	BM10X10X288CRS	132	BEAM ROUGH SAWN, WESTERN RED CEDAR
BCDCV18X8X6S	117	CORBEL, TIMBER TEXTURE, COVE	BM10X10X288CS	132	BEAM TAHOE, WESTERN RED CEDAR
BCDCV21X30X4S	117	BRACKET, TIMBER TEXTURE, COVE KNEE BRACE	BM10X10X288DS	132	BEAM,HAND DEEP STAINABLE
BCDCV21X30X6S	117	BRACKET, TIMBER TEXTURE, COVE KNEE BRACE	BM10X10X288HS	132	BEAM HAND HEWN, ELM
BCDOG15X7S	117	CORBEL, TIMBER TEXTURE	BM10X10X288WS	132	BEAM MESA, REDWOOD
BCDOG20X7S	117	CORBEL, TIMBER TEXTURE, OGEE	BM10X12X288	132	BEAM SMOOTH
BCDOG24X6S	117	CORBEL, TIMBER TEXTURE, OGEE	BM10X12X288CRS	132	BEAM ROUGH SAWN, WESTERN RED CEDAR
BCDOG8X12S	117	CORBEL, TIMBER TEXTURE, OGEE	BM10X12X288CS	132	BEAM TAHOE, WESTERN RED CEDAR
BCDOGA15X7S	117	CORBEL, TIMBER TEXTURE	BM10X12X288DS	132	BEAM,HAND DEEP STAINABLE
BCDS18X24X6S	115	BRACKET, TIMBER TEXTURE, FLAT KNEE BRACE	BM10X12X288HS	132	BEAM HAND HEWN, ELM
BL2.5X15A	154	BALUSTER ASHLEY SMOOTH	BM10X12X288WS	132	BEAM MESA, REDWOOD
BL2X20Q	154	BALUSTER SQUARE SMOOTH	BM10X7.5X288RHS	138	ROUND BEAM HAND HEWN
BL2X24Q	154	BALUSTER SQUARE SMOOTH	BM10X7.5X288RPS	138	ROUND ADOBE PEELED
BL2X28Q	154	BALUSTER SQUARE SMOOTH	BM10X7.5X288RWS	138	BEAM ROUND SANDBLASTE
BL2X32Q	154	BALUSTER SQUARE SMOOTH	BM12X9X288RHS	138	ROUND BEAM HAND HEWN
BL3X18W	154	BALUSTER WOODRUFF SMOOTH	BM12X9X288RPS	138	ROUND ADOBE PEELED
BL3X20A	154	BALUSTER ASHLEY SMOOTH	BM12X9X288RWS	138	BEAM ROUND SANDBLASTE
BL3X20C	154	BALUSTER CLASSIC SMOOTH	BM4X4X288	132	BEAM SMOOTH
BL3X20W	154	BALUSTER WOODRUFF SMOOTH	BM4X4X288CRS	132	BEAM ROUGH SAWN, WESTERN RED CEDAR
BL3X24A	154	BALUSTER ASHLEY SMOOTH	BM4X4X288CS	132	BEAM TAHOE, WESTERN RED CEDAR
BL3X24C	154	BALUSTER CLASSIC SMOOTH	BM4X4X288DS	132	BEAM,HAND DEEP STAINABLE
BL3X24L	154	BALUSTER LOGAN SMOOTH	BM4X4X288HS	132	BEAM HAND HEWN, ELM
BL3X24W	154	BALUSTER WOODRUFF SMOOTH	BM4X4X288WS	132	BEAM MESA, REDWOOD
BL3X28A	154	BALUSTER ASHLEY SMOOTH	BM4X5X192	135	BEAM SMOOTH
BL3X28C	154	BALUSTER CLASSIC SMOOTH	BM4X6X288	132	BEAM SMOOTH
BL3X28L	154	BALUSTER LOGAN SMOOTH	BM4X6X288CRS	132	BEAM ROUGH SAWN, WESTERN RED CEDAR
BL3X28W	154	BALUSTER WOODRUFF SMOOTH	BM4X6X288CS	132	BEAM TAHOE, WESTERN RED CEDAR
BL3X32A	154	BALUSTER ASHLEY SMOOTH	BM4X6X288DS	132	BEAM,HAND DEEP STAINABLE
BL3X32C	154	BALUSTER CLASSIC SMOOTH	BM4X6X288HS	132	BEAM HAND HEWN, ELM
BL3X32W	154	BALUSTER WOODRUFF SMOOTH	BM4X6X288WS	132	BEAM MESA, REDWOOD
BL3X36A	154	BALUSTER ASHLEY SMOOTH	BM5X3.6X144	135	BEAM SMOOTH
BL3X36W	154	BALUSTER WOODRUFF SMOOTH	BM6X144T	147	BEAM TOP MESA
BL4X22B	156	BALUSTER BEAUMONT SMOOTH	BM6X4.5X288RHS	138	ROUND BEAM HAND HEWN
BL4X24A	156	BALUSTER ASHLEY SMOOTH	BM6X4.5X288RPS	138	ROUND ADOBE PEELED
BL4X27CO	156	BALUSTER CLASSIC SMOOTH	BM6X4.5X288RWS	138	BEAM ROUND SANDBLASTE
BL4X31CO	156	BALUSTER CLASSIC SMOOTH	BM6X6X144CRSN	133	BEAM CEDER ROUGH SAWN NEW
BL5X19B	156	BALUSTER BEAUMONT SMOOTH	BM6X6X144DRS	133	BEAM DEEP CEDAR ROUGH SAWN
BL5X20A	156	BALUSTER ASHLEY SMOOTH	BM6X6X144LCS	133	BEAM LIGHT TAHOE
BL5X20C	156	BALUSTER CLASSIC SMOOTH	BM6X6X144SRS	133	BEAM SANDING CEDAR ROUGH SAWN
BL5X20R	156	BALUSTER ROSEDALE SMOOTH	BM6X6X144W0S	133	BEAM WHITE OAK CATHEDRAL
BL5X20W	156	BALUSTER WOODRUFF SMOOTH	BM6X6X144WSS	133	BEAM WHITE OAK STRAIGHT
BL5X22B	156	BALUSTER BEAUMONT SMOOTH	BM6X6X288	132	BEAM SMOOTH
BL5X24A	156	BALUSTER ASHLEY SMOOTH	BM6X6X288CRS	132	BEAM ROUGH SAWN, WESTERN RED CEDAR
BL5X24C	156	BALUSTER CLASSIC SMOOTH	BM6X6X288CS	132	BEAM TAHOE, WESTERN RED CEDAR
BL5X24CF	156	BALUSTER SQUARE CLASSIC SMOOTH	BM6X6X288DS	132	BEAM,HAND DEEP STAINABLE
BL5X24SF	156	BALUSTER SQUARE SPINDLE SMOOTH	BM6X6X288HS	132	BEAM HAND HEWN, ELM
BL5X24W	156	BALUSTER WOODRUFF SMOOTH	BM6X6X288WS	132	BEAM MESA, REDWOOD
BL5X28C	156	BALUSTER CLASSIC SMOOTH	BM6X8X144CRSN	133	BEAM CEDER ROUGH SAWN NEW
BL5X28CO	156	BALUSTER CLASSIC SMOOTH	BM6X8X144DRS	133	BEAM DEEP CEDAR ROUGH SAWN
BL5X28Q	156	BALUSTER SQUARE SMOOTH	BM6X8X144LCS	133	BEAM LIGHT TAHOE
BL5X28W	156	BALUSTER WOODRUFF SMOOTH	BM6X8X144SRS	133	BEAM SANDING CEDAR ROUGH SAWN
BL5X30C	156	BALUSTER CLASSIC SMOOTH	BM6X8X144W0S	133	BEAM WHITE OAK CATHEDRAL
BL5X32A	156	BALUSTER ASHLEY SMOOTH	BM6X8X144WSS	133	BEAM WHITE OAK STRAIGHT

Part#	Page	Description
BM6X8X288	132	BEAM SMOOTH
BM6X8X288CRS	132	BEAM ROUGH SAWN, WESTERN RED CEDAR
BM6X8X288CS	132	BEAM TAHOE, WESTERN RED CEDAR
BM6X8X288DS	132	BEAM,HAND DEEP STAINABLE
BM6X8X288HS	132	BEAM HAND HEWN, ELM
BM6X8X288WS	132	BEAM MESA, REDWOOD
BM6X8X60CRS-TC	142	BEAM MANTEL ROUGH SAWN
BM6X8X60HS-TC	142	BEAM MANTEL HAND HEWN
BM6X8X60-TC	143	BEAM MANTEL SMOOTH
BM6X8X60WS-TC	143	BEAM MANTEL MESA,REDWOOD
BM6X8X66CRS-TC	142	BEAM MANTEL ROUGH SAWN
BM6X8X66HS-TC	142	BEAM MANTEL HAND HEWN
BM6X8X66-TC	143	BEAM MANTEL SMOOTH
BM6X8X66WS-TC	143	BEAM MANTEL MESA,REDWOOD
BM6X8X72CRS-TC	142	BEAM MANTEL ROUGH SAWN
BM6X8X72HS-TC	142	BEAM MANTEL HAND HEWN
BM6X8X72-TC	143	BEAM MANTEL SMOOTH
BM6X8X72WS-TC	143	BEAM MANTEL MESA,REDWOOD
BM6X8X78CRS-TC	142	BEAM MANTEL ROUGH SAWN
BM6X8X78HS-TC	142	BEAM MANTEL HAND HEWN
BM6X8X78-TC	143	BEAM MANTEL SMOOTH
BM6X8X78WS-TC	143	BEAM MANTEL MESA,REDWOOD
BM6X8X84CRS-TC	142	BEAM MANTEL ROUGH SAWN
BM6X8X84HS-TC	142	BEAM MANTEL HAND HEWN
BM6X8X84-TC	143	BEAM MANTEL SMOOTH
BM6X8X84WS-TC	143	BEAM MANTEL MESA,REDWOOD
BM6X8X90CRS-TC	142	BEAM MANTEL ROUGH SAWN
BM6X8X90HS-TC	142	BEAM MANTEL HAND HEWN
BM6X8X90-TC	143	BEAM MANTEL SMOOTH
BM6X8X90WS-TC	143	BEAM MANTEL MESA,REDWOOD
BM8X10X144CRSN	133	BEAM CEDER ROUGH SAWN NEW
BM8X10X144DRS	133	BEAM DEEP CEDAR ROUGH SAWN
BM8X10X144LCS	133	BEAM LIGHT TAHOE
BM8X10X144SRS	133	BEAM SANDING CEDAR ROUGH SAWN
BM8X10X144WOS	133	BEAM WHITE OAK CATHEDRAL
BM8X10X144WSS	133	BEAM WHITE OAK STRAIGHT
BM8X10X288	132	BEAM SMOOTH
BM8X10X288CRS	132	BEAM ROUGH SAWN, WESTERN RED CEDAR
BM8X10X288CS	132	BEAM TAHOE, WESTERN RED CEDAR
BM8X10X288DS	132	BEAM,HAND DEEP STAINABLE
BM8X10X288HS	132	BEAM HAND HEWN, ELM
BM8X10X288WS	132	BEAM MESA, REDWOOD
BM8X10X60CRS-TC	142	BEAM MANTEL ROUGH SAWN
BM8X10X60HS-TC	142	BEAM MANTEL HAND HEWN
BM8X10X60-TC	143	BEAM MANTEL SMOOTH
BM8X10X60WS-TC	143	BEAM MANTEL MESA,REDWOOD
BM8X10X66CRS-TC	142	BEAM MANTEL ROUGH SAWN
BM8X10X66HS-TC	142	BEAM MANTEL HAND HEWN
BM8X10X66-TC	143	BEAM MANTEL SMOOTH
BM8X10X66WS-TC	143	BEAM MANTEL MESA,REDWOOD
BM8X10X72CRS-TC	142	BEAM MANTEL ROUGH SAWN
BM8X10X72HS-TC	142	BEAM MANTEL HAND HEWN
BM8X10X72-TC	143	BEAM MANTEL SMOOTH
BM8X10X72WS-TC	143	BEAM MANTEL MESA,REDWOOD
BM8X10X78CRS-TC	142	BEAM MANTEL ROUGH SAWN
BM8X10X78HS-TC	142	BEAM MANTEL HAND HEWN

Part#	Page	Description
BM8X10X78-TC	143	BEAM MANTEL SMOOTH
BM8X10X78WS-TC	143	BEAM MANTEL MESA,REDWOOD
BM8X10X84CRS-TC	142	BEAM MANTEL ROUGH SAWN
BM8X10X84HS-TC	142	BEAM MANTEL HAND HEWN
BM8X10X84-TC	143	BEAM MANTEL SMOOTH
BM8X10X84WS-TC	143	BEAM MANTEL MESA,REDWOOD
BM8X10X90CRS-TC	142	BEAM MANTEL ROUGH SAWN
BM8X10X90HS-TC	142	BEAM MANTEL HAND HEWN
BM8X10X90-TC	143	BEAM MANTEL SMOOTH
BM8X10X90WS-TC	143	BEAM MANTEL MESA,REDWOOD
BM8X144T	147	BEAM TOP MESA
BM8X6X288RHS	138	ROUND BEAM HAND HEWN
BM8X6X288RPS	138	ROUND ADOBE PEELED
BM8X6X288RWS	138	BEAM ROUND SANDBLASTE
BM8X8X144CRSN	133	BEAM CEDER ROUGH SAWN NEW
BM8X8X144DRS	133	BEAM DEEP CEDAR ROUGH SAWN
BM8X8X144LCS	133	BEAM LIGHT TAHOE
BM8X8X144SRS	133	BEAM SANDING CEDAR ROUGH SAWN
BM8X8X144WOS	133	BEAM WHITE OAK CATHEDRAL
BM8X8X144WSS	133	BEAM WHITE OAK STRAIGHT
BM8X8X288	132	BEAM SMOOTH
BM8X8X288CRS	132	BEAM ROUGH SAWN, WESTERN RED CEDAR
BM8X8X288CS	132	BEAM TAHOE, WESTERN RED CEDAR
BM8X8X288DS	132	BEAM,HAND DEEP STAINABLE
BM8X8X288HS	132	BEAM HAND HEWN, ELM
BM8X8X288WS	132	BEAM MESA, REDWOOD
BMBL4X6X12RS	148	BEAM RAFTER TAIL, ROUGH SAWN, BULLNOSE
BMBL4X6X18RS	148	BEAM RAFTER TAIL, ROUGH SAWN, BULLNOSE
BMBL4X6X24RS	148	BEAM RAFTER TAIL, ROUGH SAWN, BULLNOSE
BMBL4X6X30RS	148	BEAM RAFTER TAIL, ROUGH SAWN, BULLNOSE
BMBL4X6X36RS	148	BEAM RAFTER TAIL, ROUGH SAWN, BULLNOSE
BMBL4X6X42RS	148	BEAM RAFTER TAIL, ROUGH SAWN, BULLNOSE
BMBL4X8X18RS	148	BEAM RAFTER TAIL, ROUGH SAWN, BULLNOSE
BMBL4X8X24RS	148	BEAM RAFTER TAIL, ROUGH SAWN, BULLNOSE
BMBL4X8X30RS	148	BEAM RAFTER TAIL, ROUGH SAWN, BULLNOSE
BMBL4X8X36RS	148	BEAM RAFTER TAIL, ROUGH SAWN, BULLNOSE
BMBL4X8X42RS	148	BEAM RAFTER TAIL, ROUGH SAWN, BULLNOSE
BMCV4X6X12RS	148	BEAM RAFTER TAIL, ROUGH SAWN, COVE
BMCV4X6X18RS	148	BEAM RAFTER TAIL, ROUGH SAWN, COVE
BMCV4X6X24RS	148	BEAM RAFTER TAIL, ROUGH SAWN, COVE
BMCV4X6X30RS	148	BEAM RAFTER TAIL, ROUGH SAWN, COVE
BMCV4X6X36RS	148	BEAM RAFTER TAIL, ROUGH SAWN, COVE
BMCV4X6X42RS	148	BEAM RAFTER TAIL, ROUGH SAWN, COVE
BMCV4X8X18RS	148	BEAM RAFTER TAIL, ROUGH SAWN, COVE
BMCV4X8X24RS	148	BEAM RAFTER TAIL, ROUGH SAWN, COVE
BMCV4X8X30RS	148	BEAM RAFTER TAIL, ROUGH SAWN, COVE
BMCV4X8X36RS	148	BEAM RAFTER TAIL, ROUGH SAWN, COVE
BMCV4X8X42RS	148	BEAM RAFTER TAIL, ROUGH SAWN, COVE
BMFTIX12X144DRS	140	FLAT TRIM FOR WOODGRAIN BEAM
BMFTIX12X144LCS	140	FLAT TRIM FOR WOODGRAIN BEAM
BMFTIX12X144SRS	140	FLAT TRIM FOR WOODGRAIN BEAM
BMFTIX12X144WOS	140	FLAT TRIM FOR WOODGRAIN BEAM
BMFTIX12X144WSS	140	FLAT TRIM FOR WOODGRAIN BEAM
BMFTIX24X144	139	FLAT TRIM FOR WOODGRAIN BEAM
BMFTIX24X144CRS	141	FLAT TRIM FOR WOODGRAIN BEAM
BMFTIX24X144CS	139	FLAT TRIM FOR WOODGRAIN BEAM

INDEX

Part#	Page	Description	Part#	Page	Description
BMFTX24X144DS	139	FLAT TRIM FOR WOODGRAIN BEAM	BMSP8X10H	145	BEAM STRAP HAMMERED
BMFTX24X144HS	139	FLAT TRIM FOR WOODGRAIN BEAM	BMSP8X10S	145	BEAM STRAP SMOOTH
BMFTX24X144WS	139	FLAT TRIM FOR WOODGRAIN BEAM	BMSP8X8H	145	BEAM STRAP HAMMERED
BMFTX24X144CRSN	141	FLAT TRIM FOR WOODGRAIN BEAM	BMSP8X8S	145	BEAM STRAP SMOOTH
BMP10X15H	145	BEAM PLATE HAMMERED	BMSP9.5X9.5S	146	BEAM ADJUSTABLE STRAP SMOOTH
BMP10X15S	145	BEAM PLATE SMOOTH	BMSP9.5X9.5SW	146	BEAM ADJUSTABLE STRAP SMOOTH
BMP15X20H	145	BEAM PLATE HAMMERED	BMST4X6X12RS	148	BEAM RAFTER TAIL, ROUGH SAWN, STRAIGHT
BMP15X20S	145	BEAM PLATE SMOOTH	BMST4X6X18RS	148	BEAM RAFTER TAIL, ROUGH SAWN, STRAIGHT
BMP36X36H	145	BEAM PLATE HAMMERED	BMST4X6X24RS	148	BEAM RAFTER TAIL, ROUGH SAWN, STRAIGHT
BMP36X36S	145	BEAM PLATE SMOOTH	BMST4X6X30RS	148	BEAM RAFTER TAIL, ROUGH SAWN, STRAIGHT
BMP48X48H	145	BEAM PLATE HAMMERED	BMST4X6X36RS	148	BEAM RAFTER TAIL, ROUGH SAWN, STRAIGHT
BMP48X48S	145	BEAM PLATE SMOOTH	BMST4X6X42RS	148	BEAM RAFTER TAIL, ROUGH SAWN, STRAIGHT
BMP6X10H	145	BEAM PLATE HAMMERED	BMST4X8X18RS	148	BEAM RAFTER TAIL, ROUGH SAWN, STRAIGHT
BMP6X10S	145	BEAM PLATE SMOOTH	BMST4X8X24RS	148	BEAM RAFTER TAIL, ROUGH SAWN, STRAIGHT
BMP8X10H	145	BEAM PLATE HAMMERED	BMST4X8X30RS	148	BEAM RAFTER TAIL, ROUGH SAWN, STRAIGHT
BMP8X10S	145	BEAM PLATE SMOOTH	BMST4X8X36RS	148	BEAM RAFTER TAIL, ROUGH SAWN, STRAIGHT
BMS6X4X24S	149	BEAM RAFTER TAIL, TIMBER TEXTURE	BMST4X8X42RS	148	BEAM RAFTER TAIL, ROUGH SAWN, STRAIGHT
BMS8X4X24S	149	BEAM RAFTER TAIL, TIMBER TEXTURE	BMT25X12X6S	149	BEAM, TIMBER TEXTURE, RAFTER TAIL
BMSC4X6X12RS	148	BEAM RAFTER TAIL, ROUGH SAWN, SCROLL	BMT4X8X42S	149	BEAM RAFTER TAIL, TIMBER TEXTURE
BMSC4X6X18RS	148	BEAM RAFTER TAIL, ROUGH SAWN, SCROLL	BR5X144	153	BALUSTER STRAIGHT BOTTOM RAIL SMOOTH
BMSC4X6X24RS	148	BEAM RAFTER TAIL, ROUGH SAWN, SCROLL	BR5X96	153	BALUSTER STRAIGHT BOTTOM RAIL SMOOTH
BMSC4X6X30RS	148	BEAM RAFTER TAIL, ROUGH SAWN, SCROLL	BR7X120	155	BALUSTER STRAIGHT BOTTOM RAIL SMOOTH
BMSC4X6X36RS	148	BEAM RAFTER TAIL, ROUGH SAWN, SCROLL	BR7X144	155	BALUSTER STRAIGHT BOTTOM RAIL SMOOTH
BMSC4X6X42RS	148	BEAM RAFTER TAIL, ROUGH SAWN, SCROLL	BR7X96	155	BALUSTER STRAIGHT BOTTOM RAIL SMOOTH
BMSC4X8X18RS	148	BEAM RAFTER TAIL, ROUGH SAWN, SCROLL	BRK5	153	BALUSTER RAIL INSTALL KIT
BMSC4X8X24RS	148	BEAM RAFTER TAIL, ROUGH SAWN, SCROLL	BRK6-7	155	BALUSTER RAIL INSTALL KIT
BMSC4X8X30RS	148	BEAM RAFTER TAIL, ROUGH SAWN, SCROLL	CAP47E	23	PEDIMENT COMBO ECO ACORN SMOOTH
BMSC4X8X36RS	148	BEAM RAFTER TAIL, ROUGH SAWN, SCROLL	CAP50	23	PEDIMENT COMBO ACORN SMOOTH
BMSC4X8X42RS	148	BEAM RAFTER TAIL, ROUGH SAWN, SCROLL	CAP54	23	PEDIMENT COMBO ACORN SMOOTH
BMSL4X6X12RS	148	BEAM RAFTER TAIL, ROUGH SAWN, SLANT	CAP54BT	23	PEDIMENT COMBO ACORN W/BT SMOOTH
BMSL4X6X18RS	148	BEAM RAFTER TAIL, ROUGH SAWN, SLANT	CAP58	23	PEDIMENT COMBO ACORN SMOOTH
BMSL4X6X24RS	148	BEAM RAFTER TAIL, ROUGH SAWN, SLANT	CAP58BT	23	PEDIMENT COMBO ACORN W/BT SMOOTH
BMSL4X6X30RS	148	BEAM RAFTER TAIL, ROUGH SAWN, SLANT	CAP67	23	PEDIMENT COMBO ACORN SMOOTH
BMSL4X6X36RS	148	BEAM RAFTER TAIL, ROUGH SAWN, SLANT	CAP67BT	23	PEDIMENT COMBO ACORN W/BT SMOOTH
BMSL4X6X42RS	148	BEAM RAFTER TAIL, ROUGH SAWN, SLANT	CAP75	23	PEDIMENT COMBO ACORN SMOOTH
BMSL4X8X18RS	148	BEAM RAFTER TAIL, ROUGH SAWN, SLANT	CAP75BT	23	PEDIMENT COMBO ACORN W/BT SMOOTH
BMSL4X8X24RS	148	BEAM RAFTER TAIL, ROUGH SAWN, SLANT	CAP80	23	PEDIMENT COMBO ACORN SMOOTH
BMSL4X8X30RS	148	BEAM RAFTER TAIL, ROUGH SAWN, SLANT	CAP80BT	23	PEDIMENT COMBO ACORN W/BT SMOOTH
BMSL4X8X36RS	148	BEAM RAFTER TAIL, ROUGH SAWN, SLANT	CAP85	23	PEDIMENT COMBO ACORN SMOOTH
BMSL4X8X42RS	148	BEAM RAFTER TAIL, ROUGH SAWN, SLANT	CAP85BT	23	PEDIMENT COMBO ACORN W/BT SMOOTH
BMSP10X10H	145	BEAM STRAP HAMMERED	CCCD144X9BT	12	CRAFTMAN COVE CROSSHEAD
BMSP10X10S	145	BEAM STRAP SMOOTH	CCCD216X9BT	12	CRAFTMAN COVE END CAPS
BMSP10X12H	145	BEAM STRAP HAMMERED	CCCD36X9BT	12	CRAFTMAN COVE CROSSHEAD
BMSP10X12S	145	BEAM STRAP SMOOTH	CCCD48X9BT	12	CRAFTMAN COVE CROSSHEAD
BMSP12.5X12.5S	146	BEAM ADJUSTABLE STRAP SMOOTH	CCD144X6	13	DISTINCTION CROSSHEAD
BMSP12.5X12.5SW	146	BEAM ADJUSTABLE STRAP SMOOTH	CCD216X6	13	CRAFTMAN COVE END CAPS
BMSP20.5X20.5S	146	BEAM ADJUSTABLE STRAP SMOOTH	CCD36X6	13	DISTINCTION CROSSHEAD
BMSP20.5X20.5SW	146	BEAM ADJUSTABLE STRAP SMOOTH	CCD48X6	13	DISTINCTION CROSSHEAD
BMSP4X4H	145	BEAM STRAP HAMMERED	CCEC4X9BT	12	CRAFTMAN COVE END CAPS
BMSP4X4S	145	BEAM STRAP SMOOTH	CCEC6X9BT	12	DISTINCTION CROSSHEAD
BMSP4X6H	145	BEAM STRAP HAMMERED	CCP37	21	PEDIMENT COMBO PEAKED CAP SMOOTH
BMSP4X6S	145	BEAM STRAP SMOOTH	CCP37BT	21	PEDIMENT COMBO PEAKED W/BT SMOOTH
BMSP6X6H	145	BEAM STRAP HAMMERED	CCSD144X6	14	DISTINCTION STEP CROSSHEAD
BMSP6X6S	145	BEAM STRAP SMOOTH	CCSD144X8	14	DISTINCTION STEP CROSSHEAD
BMSP6X8H	145	BEAM STRAP HAMMERED	CCSD216X6	14	DISTINCTION STEP CROSSHEAD
BMSP6X8S	145	BEAM STRAP SMOOTH	CCSD216X8	14	DISTINCTION STEP CROSSHEAD

Part#	Page	Description	Part#	Page	Description
CCSD36X6	14	DISTINCTION STEP CROSSHEAD	CM31WI	85	CEILING MEDALLION IPC WINDSOR SMOOTH
CCSD36X8	14	DISTINCTION STEP CROSSHEAD	CM32RO	85	CEILING MEDALLION IPC ROCHELLE SMOOTH
CCSD48X6	14	DISTINCTION STEP CROSSHEAD	CM32RO2	86	CEILING MEDALLION 2PC ROCHELLE SMOOTH
CCSD48X8	14	DISTINCTION STEP CROSSHEAD	CM34RE	85	CEILING MEDALLION IPC REECE SMOOTH
CEC4X6	13	CRAFTMAN COVE END CAPS	CM36NI	86	CEILING MEDALLION IPC NICHOLAS SMOOTH
CEC4X9	13	CRAFTMAN COVE END CAPS	CP10NM	167	COLUMN WRAP CAP BASE NECK MOULD
CEC7X6	13	CRAFTMAN COVE END CAPS	CP12NM	167	COLUMN WRAP CAP BASE NECK MOULD
CEC7X9	13	DISTINCTION STEP CROSSHEAD	CP17NM	169	COLUMN WRAP CAP BASE NECK MOULD
CF24X4	32	TRIM CIRCLE SMOOTH	CP6NM	167	COLUMN WRAP CAP BASE NECK MOULD
CF36X4	32	TRIM CIRCLE SMOOTH	CP8NM	167	COLUMN WRAP CAP BASE NECK MOULD
CLV12X24	93	CATHEDRAL LOUVER DECO SMOOTH	CPBPB16X16X16	175	BRICK COLUMN BASE PAK
CLV12X24F	93	LOUVER FUNC CATHEDRAL SMOOTH	CPBPB16X16X24	175	BRICK COLUMN BASE PAK
CLV12X24FS	99	CATHEDRAL LOUVER FUNC,TMBER TEXTURE	CPBPB16X16X32	175	BRICK COLUMN BASE PAK
CLV12X24S	99	CATHEDRAL LOUVER DECO,TMBER TEXTURE	CPBPB20X20X24	175	BRICK COLUMN BASE PAK
CLV14X22	93	CATHEDRAL LOUVER DECO SMOOTH	CPBPB20X20X32	175	BRICK COLUMN BASE PAK
CLV14X22F	93	LOUVER FUNC CATHEDRAL SMOOTH	CPBPB20X20X36	175	BRICK COLUMN BASE PAK
CLV14X22FS	99	CATHEDRAL LOUVER FUNC,TMBER TEXTURE	CPBPS16X16X16	173	STONE COLUMN BASE PAK
CLV14X22S	99	CATHEDRAL LOUVER DECO,TMBER TEXTURE	CPBPS16X16X24	173	STONE COLUMN BASE PAK
CLV16X36	93	CATHEDRAL LOUVER DECO SMOOTH	CPBPS16X16X32	173	STONE COLUMN BASE PAK
CLV16X36F	93	LOUVER FUNC CATHEDRAL SMOOTH	CPBPS20X20X24	173	STONE COLUMN BASE PAK
CLV16X36FS	99	CATHEDRAL LOUVER FUNC,TMBER TEXTURE	CPBPS20X20X32	173	STONE COLUMN BASE PAK
CLV16X36S	99	CATHEDRAL LOUVER DECO,TMBER TEXTURE	CPBPS20X20X36	173	STONE COLUMN BASE PAK
CLV18X24	93	CATHEDRAL LOUVER DECO SMOOTH	CPCB10CF	167	COLUMN WRAP CAP BASE CRAFTSMAN
CLV18X24F	93	LOUVER FUNC CATHEDRAL SMOOTH	CPCB10GK	167	COLUMN WRAP CAP BASE GREEK
CLV18X24FS	99	CATHEDRAL LOUVER FUNC,TMBER TEXTURE	CPCB10PL	167	COLUMN WRAP CAP BASE PLAIN
CLV18X24S	99	CATHEDRAL LOUVER DECO,TMBER TEXTURE	CPCB10RO	167	COLUMN WRAP CAP BASE ROMAN
CLV18X30	93	CATHEDRAL LOUVER DECO SMOOTH	CPCB10TR	167	COLUMN WRAP CAP BASE TRADITIONAL
CLV18X30F	93	LOUVER FUNC CATHEDRAL SMOOTH	CPCB10TS	167	COLUMN WRAP CAP BASE TUSCAN
CLV18X30FS	99	CATHEDRAL LOUVER FUNC,TMBER TEXTURE	CPCB11X16CF	169	COLUMN WRAP CAP BASE CRAFTSMAN
CLV18X30S	99	CATHEDRAL LOUVER DECO,TMBER TEXTURE	CPCB11X16GK	169	COLUMN WRAP CAP BASE GREEK
CLV18X30X4F	93	TRIM CATHEDRAL LOUVER SMOOTH	CPCB11X16RO	169	COLUMN WRAP CAP BASE ROMAN
CLV22X31	93	CATHEDRAL LOUVER DECO SMOOTH	CPCB11X16TS	169	COLUMN WRAP CAP BASE TUSCAN
CLV22X31F	93	LOUVER FUNC CATHEDRAL SMOOTH	CPCB12CF	167	COLUMN WRAP CAP BASE CRAFTSMAN
CLV22X31FS	99	CATHEDRAL LOUVER FUNC,TMBER TEXTURE	CPCB12GK	167	COLUMN WRAP CAP BASE GREEK
CLV22X31S	99	CATHEDRAL LOUVER DECO,TMBER TEXTURE	CPCB12PL	167	COLUMN WRAP CAP BASE PLAIN
CLV22X31X4F	93	TRIM CATHEDRAL LOUVER SMOOTH	CPCB12RO	167	COLUMN WRAP CAP BASE ROMAN
CLV24X48	93	CATHEDRAL LOUVER DECO SMOOTH	CPCB12TR	167	COLUMN WRAP CAP BASE TRADITIONAL
CLV24X48F	93	LOUVER FUNC CATHEDRAL SMOOTH	CPCB12TS	167	COLUMN WRAP CAP BASE TUSCAN
CLV24X48FS	99	CATHEDRAL LOUVER FUNC,TMBER TEXTURE	CPCB13X20CF	169	COLUMN WRAP CAP BASE CRAFTSMAN
CLV24X48S	99	CATHEDRAL LOUVER DECO,TMBER TEXTURE	CPCB13X20GK	169	COLUMN WRAP CAP BASE GREEK
CLV28X43	93	CATHEDRAL LOUVER DECO SMOOTH	CPCB13X20RO	169	COLUMN WRAP CAP BASE ROMAN
CLV28X43F	93	LOUVER FUNC CATHEDRAL SMOOTH	CPCB13X20TS	169	COLUMN WRAP CAP BASE TUSCAN
CLV28X43FS	99	CATHEDRAL LOUVER FUNC,TMBER TEXTURE	CPCB16X24CF	169	COLUMN WRAP CAP BASE CRAFTSMAN
CLV28X43S	99	CATHEDRAL LOUVER DECO,TMBER TEXTURE	CPCB16X24GK	169	COLUMN WRAP CAP BASE GREEK
CLV36X48	93	CATHEDRAL LOUVER DECO SMOOTH	CPCB16X24RO	169	COLUMN WRAP CAP BASE ROMAN
CLV36X48F	93	LOUVER FUNC CATHEDRAL SMOOTH	CPCB16X24TS	169	COLUMN WRAP CAP BASE TUSCAN
CLV36X48FS	99	CATHEDRAL LOUVER FUNC,TMBER TEXTURE	CPCB6CF	167	COLUMN WRAP CAP BASE CRAFTSMAN
CLV36X48S	99	CATHEDRAL LOUVER DECO,TMBER TEXTURE	CPCB6GK	167	COLUMN WRAP CAP BASE GREEK
CM14BL	85	CEILING MEDALLION 1PC BELMONT SMOOTH	CPCB6PL	167	COLUMN WRAP CAP BASE PLAIN
CM15BM	85	CEILING MEDALLION 1PC BEAUMONT SMOOTH	CPCB6RO	167	COLUMN WRAP CAP BASE ROMAN
CM16FL	85	CEILING MEDALLION 1PC FLORENTINE SMOOTH	CPCB6TR	167	COLUMN WRAP CAP BASE TRADITIONAL
CM16JE	85	CEILING MEDALLION 1PC JEFFERSON SMOOTH	CPCB6TS	167	COLUMN WRAP CAP BASE TUSCAN
CM16JE2	86	CEILING MEDALLION 2PC JEFFERSON SMOOTH	CPCB8CF	167	COLUMN WRAP CAP BASE CRAFTSMAN
CM16TL	85	CEILING MEDALLION 1PC TRADITIONAL SMOOTH	CPCB8GK	167	COLUMN WRAP CAP BASE GREEK
CM24RE	85	CEILING MEDALLION 1PC REECE SMOOTH	CPCB8PL	167	COLUMN WRAP CAP BASE PLAIN
CM24RN	85	CEILING MEDALLION 1PC RANDOLPH SMOOTH	CPCB8RO	167	COLUMN WRAP CAP BASE ROMAN

INDEX

Part#	Page	Description	Part#	Page	Description
CPCB8TR	167	COLUMN WRAP CAP BASE TRADITIONAL	CPVPM10X144FL	165	PREMIUMSELECT SQUARE FLUTED
CPCB8TS	167	COLUMN WRAP CAP BASE TUSCAN	CPVPM10X144FT	165	PREMIUMSELECT SQUARE FLAT
CPCB8X12CF	169	COLUMN WRAP CAP BASE CRAFTSMAN	CPVPM10X144RC	165	PREMIUMSELECT SQUARE RECESSED
CPCB8X12GK	169	COLUMN WRAP CAP BASE GREEK	CPVPM10X144RS	165	PREMIUMSELECT SQUARE RAISED
CPCB8X12RO	169	COLUMN WRAP CAP BASE ROMAN	CPVPM10X72FL	165	PREMIUMSELECT SQUARE FLUTED
CPCB8X12TS	169	COLUMN WRAP CAP BASE TUSCAN	CPVPM10X72FT	165	PREMIUMSELECT SQUARE FLAT
CPCP48	22	COMBINATION PEAKED CAP PEDIMENT	CPVPM10X72RC	165	PREMIUMSELECT SQUARE RECESSED
CPCP48BT	22	COMBINATION PEAKED CAP PEDIMENT	CPVPM10X72RS	165	PREMIUMSELECT SQUARE RAISED
CPCP50	22	COMBINATION PEAKED CAP PEDIMENT	CPVPM10X96FL	165	PREMIUMSELECT SQUARE FLUTED
CPCP50BT	22	COMBINATION PEAKED CAP PEDIMENT	CPVPM10X96FT	165	PREMIUMSELECT SQUARE FLAT
CPCP54	22	COMBINATION PEAKED CAP PEDIMENT	CPVPM10X96RC	165	PREMIUMSELECT SQUARE RECESSED
CPCP54BT	22	COMBINATION PEAKED CAP PEDIMENT	CPVPM10X96RS	165	PREMIUMSELECT SQUARE RAISED
CPCP58	22	COMBINATION PEAKED CAP PEDIMENT	CPVPM11X16X48FT	168	PREMIUMSELECT TAPERED FLAT
CPCP58BT	22	COMBINATION PEAKED CAP PEDIMENT	CPVPM11X16X48RC	168	PREMIUMSELECT TAPERED RECESSED
CPCP67	22	COMBINATION PEAKED CAP PEDIMENT	CPVPM11X16X48RS	168	PREMIUMSELECT TAPERED RAISED
CPCP67BT	22	COMBINATION PEAKED CAP PEDIMENT	CPVPM11X16X54FT	168	PREMIUMSELECT TAPERED FLAT
CPCP75	22	COMBINATION PEAKED CAP PEDIMENT	CPVPM11X16X54RC	168	PREMIUMSELECT TAPERED RECESSED
CPCP75BT	22	COMBINATION PEAKED CAP PEDIMENT	CPVPM11X16X54RS	168	PREMIUMSELECT TAPERED RAISED
CPCP80	22	COMBINATION PEAKED CAP PEDIMENT	CPVPM11X16X60FT	168	PREMIUMSELECT TAPERED FLAT
CPCP80BT	22	COMBINATION PEAKED CAP PEDIMENT	CPVPM11X16X60RC	168	PREMIUMSELECT TAPERED RECESSED
CPCP85	22	COMBINATION PEAKED CAP PEDIMENT	CPVPM11X16X60RS	168	PREMIUMSELECT TAPERED RAISED
CPCP85BT	22	COMBINATION PEAKED CAP PEDIMENT	CPVPM11X16X66FT	168	PREMIUMSELECT TAPERED FLAT
CPINSTALLKIT	172	INSTALLATION KIT	CPVPM11X16X66RC	168	PREMIUMSELECT TAPERED RECESSED
CPINSTALLKIT-1	172	INSTALLATION KIT	CPVPM11X16X66RS	168	PREMIUMSELECT TAPERED RAISED
CPUPF10X108FT	171	COLUMN WRAP EVERCEDAR SQUARE FLAT	CPVPM11X16X72FT	168	PREMIUMSELECT TAPERED FLAT
CPUPF10X120FT	171	COLUMN WRAP EVERCEDAR SQUARE FLAT	CPVPM11X16X72RC	168	PREMIUMSELECT TAPERED RECESSED
CPUPF10X96FT	171	COLUMN WRAP EVERCEDAR SQUARE FLAT	CPVPM11X16X72RS	168	PREMIUMSELECT TAPERED RAISED
CPUPF11X16X48FT	172	COLUMN WRAP EVERCEDAR TAPERED FLAT	CPVPM11X16X96FT	168	PREMIUMSELECT TAPERED FLAT
CPUPF11X16X54FT	172	COLUMN WRAP EVERCEDAR TAPERED FLAT	CPVPM11X16X96RC	168	PREMIUMSELECT TAPERED RECESSED
CPUPF11X16X60FT	172	COLUMN WRAP EVERCEDAR TAPERED FLAT	CPVPM11X16X96RS	168	PREMIUMSELECT TAPERED RAISED
CPUPF11X16X66FT	172	COLUMN WRAP EVERCEDAR TAPERED FLAT	CPVPM12X108FL	165	PREMIUMSELECT SQUARE FLUTED
CPUPF11X16X72FT	172	COLUMN WRAP EVERCEDAR TAPERED FLAT	CPVPM12X108FT	165	PREMIUMSELECT SQUARE FLAT
CPUPF11X16X96FT	172	COLUMN WRAP EVERCEDAR TAPERED FLAT	CPVPM12X108RC	165	PREMIUMSELECT SQUARE RECESSED
CPUPF12X108FT	171	COLUMN WRAP EVERCEDAR SQUARE FLAT	CPVPM12X108RS	165	PREMIUMSELECT SQUARE RAISED
CPUPF12X120FT	171	COLUMN WRAP EVERCEDAR SQUARE FLAT	CPVPM12X120FL	165	PREMIUMSELECT SQUARE FLUTED
CPUPF12X96FT	171	COLUMN WRAP EVERCEDAR SQUARE FLAT	CPVPM12X120FT	165	PREMIUMSELECT SQUARE FLAT
CPUPF6X108FT	171	COLUMN WRAP EVERCEDAR SQUARE FLAT	CPVPM12X120RC	165	PREMIUMSELECT SQUARE RECESSED
CPUPF6X120FT	171	COLUMN WRAP EVERCEDAR SQUARE FLAT	CPVPM12X120RS	165	PREMIUMSELECT SQUARE RAISED
CPUPF6X96FT	171	COLUMN WRAP EVERCEDAR SQUARE FLAT	CPVPM12X144FL	165	PREMIUMSELECT SQUARE FLUTED
CPUPF8X108FT	171	COLUMN WRAP EVERCEDAR SQUARE FLAT	CPVPM12X144FT	165	PREMIUMSELECT SQUARE FLAT
CPUPF8X120FT	171	COLUMN WRAP EVERCEDAR SQUARE FLAT	CPVPM12X144RC	165	PREMIUMSELECT SQUARE RECESSED
CPUPF8X12X48FT	172	COLUMN WRAP EVERCEDAR TAPERED FLAT	CPVPM12X144RS	165	PREMIUMSELECT SQUARE RAISED
CPUPF8X12X54FT	172	COLUMN WRAP EVERCEDAR TAPERED FLAT	CPVPM12X72FL	165	PREMIUMSELECT SQUARE FLUTED
CPUPF8X12X60FT	172	COLUMN WRAP EVERCEDAR TAPERED FLAT	CPVPM12X72FT	165	PREMIUMSELECT SQUARE FLAT
CPUPF8X12X66FT	172	COLUMN WRAP EVERCEDAR TAPERED FLAT	CPVPM12X72RC	165	PREMIUMSELECT SQUARE RECESSED
CPUPF8X12X72FT	172	COLUMN WRAP EVERCEDAR TAPERED FLAT	CPVPM12X72RS	165	PREMIUMSELECT SQUARE RAISED
CPUPF8X12X96FT	172	COLUMN WRAP EVERCEDAR TAPERED FLAT	CPVPM12X96FL	165	PREMIUMSELECT SQUARE FLUTED
CPUPF8X96FT	171	COLUMN WRAP EVERCEDAR SQUARE FLAT	CPVPM12X96FT	165	PREMIUMSELECT SQUARE FLAT
CPVPM10X108FL	165	PREMIUMSELECT SQUARE FLUTED	CPVPM12X96RC	165	PREMIUMSELECT SQUARE RECESSED
CPVPM10X108FT	165	PREMIUMSELECT SQUARE FLAT	CPVPM12X96RS	165	PREMIUMSELECT SQUARE RAISED
CPVPM10X108RC	165	PREMIUMSELECT SQUARE RECESSED	CPVPM13X20X48FT	168	PREMIUMSELECT TAPERED FLAT
CPVPM10X108RS	165	PREMIUMSELECT SQUARE RAISED	CPVPM13X20X48RC	168	PREMIUMSELECT TAPERED RECESSED
CPVPM10X120FL	165	PREMIUMSELECT SQUARE FLUTED	CPVPM13X20X48RS	168	PREMIUMSELECT TAPERED RAISED
CPVPM10X120FT	165	PREMIUMSELECT SQUARE FLAT	CPVPM13X20X54FT	168	PREMIUMSELECT TAPERED FLAT
CPVPM10X120RC	165	PREMIUMSELECT SQUARE RECESSED	CPVPM13X20X54RC	168	PREMIUMSELECT TAPERED RECESSED
CPVPM10X120RS	165	PREMIUMSELECT SQUARE RAISED	CPVPM13X20X54RS	168	PREMIUMSELECT TAPERED RAISED

INDEX

Part#	Page	Description	Part#	Page	Description
CPVPM13X20X60FT	168	PREMIUMSELECT TAPERED FLAT	CPVPM8X12X72RC	168	PREMIUMSELECT TAPERED RECESSED
CPVPM13X20X60RC	168	PREMIUMSELECT TAPERED RECESSED	CPVPM8X12X72RS	168	PREMIUMSELECT TAPERED RAISED
CPVPM13X20X60RS	168	PREMIUMSELECT TAPERED RAISED	CPVPM8X12X96FT	168	PREMIUMSELECT TAPERED FLAT
CPVPM13X20X66FT	168	PREMIUMSELECT TAPERED FLAT	CPVPM8X12X96RC	168	PREMIUMSELECT TAPERED RECESSED
CPVPM13X20X66RC	168	PREMIUMSELECT TAPERED RECESSED	CPVPM8X12X96RS	168	PREMIUMSELECT TAPERED RAISED
CPVPM13X20X66RS	168	PREMIUMSELECT TAPERED RAISED	CPVPM8X144FL	165	PREMIUMSELECT SQUARE FLUTED
CPVPM13X20X72FT	168	PREMIUMSELECT TAPERED FLAT	CPVPM8X144FT	165	PREMIUMSELECT SQUARE FLAT
CPVPM13X20X72RC	168	PREMIUMSELECT TAPERED RECESSED	CPVPM8X144RC	165	PREMIUMSELECT SQUARE RECESSED
CPVPM13X20X72RS	168	PREMIUMSELECT TAPERED RAISED	CPVPM8X144RS	165	PREMIUMSELECT SQUARE RAISED
CPVPM13X20X96FT	168	PREMIUMSELECT TAPERED FLAT	CPVPM8X72FL	165	PREMIUMSELECT SQUARE FLUTED
CPVPM13X20X96RC	168	PREMIUMSELECT TAPERED RECESSED	CPVPM8X72FT	165	PREMIUMSELECT SQUARE FLAT
CPVPM13X20X96RS	168	PREMIUMSELECT TAPERED RAISED	CPVPM8X72RC	165	PREMIUMSELECT SQUARE RECESSED
CPVPM16X24X48FT	168	PREMIUMSELECT TAPERED FLAT	CPVPM8X72RS	165	PREMIUMSELECT SQUARE RAISED
CPVPM16X24X48RC	168	PREMIUMSELECT TAPERED RECESSED	CPVPM8X96FL	165	PREMIUMSELECT SQUARE FLUTED
CPVPM16X24X48RS	168	PREMIUMSELECT TAPERED RAISED	CPVPM8X96FT	165	PREMIUMSELECT SQUARE FLAT
CPVPM16X24X54FT	168	PREMIUMSELECT TAPERED FLAT	CPVPM8X96RC	165	PREMIUMSELECT SQUARE RECESSED
CPVPM16X24X54RC	168	PREMIUMSELECT TAPERED RECESSED	CPVPM8X96RS	165	PREMIUMSELECT SQUARE RAISED
CPVPM16X24X54RS	168	PREMIUMSELECT TAPERED RAISED	CPVPMFP10X108FT	166	PREMIUMSELECT FLAT-PACK SQUARE FLAT COLUMN WRAP
CPVPM16X24X60FT	168	PREMIUMSELECT TAPERED FLAT	CPVPMFP10X120FT	166	PREMIUMSELECT FLAT-PACK SQUARE FLAT COLUMN WRAP
CPVPM16X24X60RC	168	PREMIUMSELECT TAPERED RECESSED	CPVPMFP10X96FT	166	PREMIUMSELECT FLAT-PACK SQUARE FLAT COLUMN WRAP
CPVPM16X24X60RS	168	PREMIUMSELECT TAPERED RAISED	CPVPMFP11X16X60FT	169	PREMIUMSELECT FLAT-PACK SQUARE FLAT COLUMN WRAP
CPVPM16X24X66FT	168	PREMIUMSELECT TAPERED FLAT	CPVPMFP11X16X66FT	169	PREMIUMSELECT FLAT-PACK SQUARE FLAT COLUMN WRAP
CPVPM16X24X66RC	168	PREMIUMSELECT TAPERED RECESSED	CPVPMFP11X16X72FT	169	PREMIUMSELECT FLAT-PACK SQUARE FLAT COLUMN WRAP
CPVPM16X24X66RS	168	PREMIUMSELECT TAPERED RAISED	CPVPMFP6X108FT	166	PREMIUMSELECT FLAT-PACK SQUARE FLAT COLUMN WRAP
CPVPM16X24X72FT	168	PREMIUMSELECT TAPERED FLAT	CPVPMFP6X120FT	166	PREMIUMSELECT FLAT-PACK SQUARE FLAT COLUMN WRAP
CPVPM16X24X72RC	168	PREMIUMSELECT TAPERED RECESSED	CPVPMFP6X96FT	166	PREMIUMSELECT FLAT-PACK SQUARE FLAT COLUMN WRAP
CPVPM16X24X72RS	168	PREMIUMSELECT TAPERED RAISED	CPVPMFP8X108FT	166	PREMIUMSELECT FLAT-PACK SQUARE FLAT COLUMN WRAP
CPVPM16X24X96FT	168	PREMIUMSELECT TAPERED FLAT	CPVPMFP8X120FT	166	PREMIUMSELECT FLAT-PACK SQUARE FLAT COLUMN WRAP
CPVPM16X24X96RC	168	PREMIUMSELECT TAPERED RECESSED	CPVPMFP8X12X60FT	169	PREMIUMSELECT FLAT-PACK SQUARE FLAT COLUMN WRAP
CPVPM16X24X96RS	168	PREMIUMSELECT TAPERED RAISED	CPVPMFP8X12X66FT	169	PREMIUMSELECT FLAT-PACK SQUARE FLAT COLUMN WRAP
CPVPM6X108FT	165	PREMIUMSELECT SQUARE FLAT	CPVPMFP8X12X72FT	169	PREMIUMSELECT FLAT-PACK SQUARE FLAT COLUMN WRAP
CPVPM6X120FT	165	PREMIUMSELECT SQUARE FLAT	CPVPMFP8X96FT	166	PREMIUMSELECT FLAT-PACK SQUARE FLAT COLUMN WRAP
CPVPM6X144FT	165	PREMIUMSELECT SQUARE FLAT	CPVPS10X108FT	164	PROSELECT SQUARE FLAT
CPVPM6X72FT	165	PREMIUMSELECT SQUARE FLAT	CPVPS10X120FT	164	PROSELECT SQUARE FLAT
CPVPM6X96FT	165	PREMIUMSELECT SQUARE FLAT	CPVPS10X144FT	164	PROSELECT SQUARE FLAT
CPVPM8X108FL	165	PREMIUMSELECT SQUARE FLUTED	CPVPS10X72FT	164	PROSELECT SQUARE FLAT
CPVPM8X108FT	165	PREMIUMSELECT SQUARE FLAT	CPVPS10X96FT	164	PROSELECT SQUARE FLAT
CPVPM8X108RC	165	PREMIUMSELECT SQUARE RECESSED	CPVPS12X108FT	164	PROSELECT SQUARE FLAT
CPVPM8X108RS	165	PREMIUMSELECT SQUARE RAISED	CPVPS12X120FT	164	PROSELECT SQUARE FLAT
CPVPM8X120FL	165	PREMIUMSELECT SQUARE FLUTED	CPVPS12X144FT	164	PROSELECT SQUARE FLAT
CPVPM8X120FT	165	PREMIUMSELECT SQUARE FLAT	CPVPS12X72FT	164	PROSELECT SQUARE FLAT
CPVPM8X120RC	165	PREMIUMSELECT SQUARE RECESSED	CPVPS12X96FT	164	PROSELECT SQUARE FLAT
CPVPM8X120RS	165	PREMIUMSELECT SQUARE RAISED	CPVPS6X108FT	164	PROSELECT SQUARE FLAT
CPVPM8X12X48FT	168	PREMIUMSELECT TAPERED FLAT	CPVPS6X120FT	164	PROSELECT SQUARE FLAT
CPVPM8X12X48RC	168	PREMIUMSELECT TAPERED RECESSED	CPVPS6X144FT	164	PROSELECT SQUARE FLAT
CPVPM8X12X48RS	168	PREMIUMSELECT TAPERED RAISED	CPVPS6X72FT	164	PROSELECT SQUARE FLAT
CPVPM8X12X54FT	168	PREMIUMSELECT TAPERED FLAT	CPVPS6X96FT	164	PROSELECT SQUARE FLAT
CPVPM8X12X54RC	168	PREMIUMSELECT TAPERED RECESSED	CPVPS8X108FT	164	PROSELECT SQUARE FLAT
CPVPM8X12X54RS	168	PREMIUMSELECT TAPERED RAISED	CPVPS8X120FT	164	PROSELECT SQUARE FLAT
CPVPM8X12X60FT	168	PREMIUMSELECT TAPERED FLAT	CPVPS8X144FT	164	PROSELECT SQUARE FLAT
CPVPM8X12X60RC	168	PREMIUMSELECT TAPERED RECESSED	CPVPS8X72FT	164	PROSELECT SQUARE FLAT
CPVPM8X12X60RS	168	PREMIUMSELECT TAPERED RAISED	CPVPS8X96FT	164	PROSELECT SQUARE FLAT
CPVPM8X12X66FT	168	PREMIUMSELECT TAPERED FLAT	CPVPSFP6X6X108FT	164	PROSELECT FLAT-PACK SQUARE FLAT COLUMN WRAP
CPVPM8X12X66RC	168	PREMIUMSELECT TAPERED RECESSED	CPVPSFP6X6X96FT	164	PROSELECT FLAT-PACK SQUARE FLAT COLUMN WRAP
CPVPM8X12X66RS	168	PREMIUMSELECT TAPERED RAISED	CSP54	18	COMBINATION SUNBURST PEDIMENT
CPVPM8X12X72FT	168	PREMIUMSELECT TAPERED FLAT	CSP54BT	18	COMBINATION SUNBURST PEDIMENT

INDEX

Part#	Page	Description	Part#	Page	Description
CSP75	18	COMBINATION SUNBURST PEDIMENT	FT125-8	63	FLAT TRIM SMOOTH
CSP75BT	18	COMBINATION SUNBURST PEDIMENT	FT131-16	63	FLAT TRIM SMOOTH
CSP80	18	COMBINATION SUNBURST PEDIMENT	FT150-12S	177	FLAT TRIM, TIMBER TEXTURE
CSP80BT	18	COMBINATION SUNBURST PEDIMENT	FT151-12S	177	FLAT TRIM, TIMBER TEXTURE
CSP85	18	COMBINATION SUNBURST PEDIMENT	FT152-12	63	FLAT TRIM SMOOTH
CSP85BT	18	COMBINATION SUNBURST PEDIMENT	FT152-16	63	FLAT TRIM SMOOTH
DH58X18	20	CROSSHEAD LARGE DOOR SMOOTH	FT152-8	63	FLAT TRIM SMOOTH
DH62X18	20	CROSSHEAD LARGE DOOR SMOOTH	FT153-12	63	FLAT TRIM SMOOTH
DH87X18	20	CROSSHEAD LARGE DOOR SMOOTH	FT159-12	63	FLAT TRIM SMOOTH
DH90X18	20	CROSSHEAD LARGE DOOR SMOOTH	FT159-16	63	FLAT TRIM SMOOTH
DH94X18	20	CROSSHEAD LARGE DOOR SMOOTH	FT159-8	63	FLAT TRIM SMOOTH
DLV24X24	91	DIAMOND LOUVER DECO SMOOTH	FT162-14	63	FLAT TRIM SMOOTH
DLV24X24F	91	LOUVER FUNC DIAMOND SMOOTH	FT162-8	63	FLAT TRIM SMOOTH
DP28X28CH	128	DECORATIVE PANEL CROSSHATCH SMOOTH	FT163-16	63	FLAT TRIM SMOOTH
DP28X28CH-B*	128	FUNCTIONAL PANEL CROSSHATCH SMOOTH	FT170-12	63	FLAT TRIM SMOOTH
DP28X28SQX	128	DECORATIVE PANEL SQUARE SMOOTH	FT170-16	63	FLAT TRIM SMOOTH
DSB4	128	DENTIL SHELF	FT172-16	63	FLAT TRIM SMOOTH
DSW4	128	DENTIL SHELF	FT173-12S	177	FLAT TRIM, TIMBER TEXTURE
DT44	31	DORMER TRIM SYSTEM PEDIMENT SMOOTH	FT175-12	63	FLAT TRIM SMOOTH
DTR457-10	31	DORMER TRIM SYSTEM RETURN SMOOTH	FT178-8	63	FLAT TRIM SMOOTH
DTST7X69	31	DORMER TRIM SYSTEM SIDE TRIM SMOOTH	FT179-12	63	FLAT TRIM SMOOTH
DVP40	25	PEDIMENT DLX VICTORIAN SMOOTH	FT180-12	63	FLAT TRIM SMOOTH
ELV12X24	88	EYEBROW LOUVER DECO SMOOTH	FT182-12	63	FLAT TRIM SMOOTH
ELV12X24F	88	LOUVER FUNC EYEBROW SMOOTH	FT183-12	63	FLAT TRIM SMOOTH
ELV12X24FS	97	EYEBROW LOUVER FUNC,WOODGRAIN	FT185-12	63	FLAT TRIM SMOOTH
ELV12X24S	97	EYEBROW LOUVER DECO,WOODGRAIN	FT186-16	63	FLAT TRIM SMOOTH
ELV18X30	88	EYEBROW LOUVER DECO SMOOTH	FT187-12S	177	FLAT TRIM, TIMBER TEXTURE
ELV18X30F	88	LOUVER FUNC EYEBROW SMOOTH	FT190-12	63	FLAT TRIM SMOOTH
ELV18X30FS	97	EYEBROW LOUVER FUNC,WOODGRAIN	FT192-12S	177	FLAT TRIM, TIMBER TEXTURE
ELV18X30S	97	EYEBROW LOUVER DECO,WOODGRAIN	FT194-10	63	FLAT TRIM SMOOTH
ELV22X32	88	EYEBROW LOUVER DECO SMOOTH	FT197-12S	177	FLAT TRIM, TIMBER TEXTURE
ELV22X32F	88	LOUVER FUNC EYEBROW SMOOTH	FT1X19.5X142S	178	WOODGRAN SIDING
ELV22X32FS	97	EYEBROW LOUVER FUNC,WOODGRAIN	FT1X3-12	58	FLAT TRIM, RAIL SHAKER SHUTTER
ELV22X32S	97	EYEBROW LOUVER DECO,WOODGRAIN	FT1X4.5X144	63	WINDOW PANEL FLAT SMOOTH
ESWDH76X23	17	PEDIMENT ELLIPTICAL SUNBURST W/DECO TRIM SMOOTH	FT1X4-12RS	58	BATTEN, TIMBER TEXTURE
F100	108	DENTIL BLOCK SMOOTH	FT1X8X99S	178	WOODGRAN SIDING
FP12X96	31	FLUTED PANEL TRIM SMOOTH	FT30X228X1S	177	FLAT TRIM, TIMBER TEXTURE
FSP103X17	179	FISHSCALE PANEL SMOOTH	FT40X96	63	WINDOW PANEL FLAT SMOOTH
FT0.5X24X118S	178	WOODGRAN SIDING	FT40X96X2	63	WINDOW PANEL FLAT SMOOTH
FT0.75X6.75X94S	178	WOODGRAN SIDING	FT9X4X216S	177	FLAT TRIM, TIMBER TEXTURE
FT0.75X6.75X98LS	178	WOODGRAN SIDING LAUAN	GP100	127	GABLE PEDIMENT KITS
FT0.75X6.75X98S	178	WOODGRAN SIDING	GP64X32	126	GABLE PEDIMENT VICTORIAN SMOOTH
FT0.75X7X79S	178	WOODGRAN SIDING	GP80X33	126	GABLE PEDIMENT VICTORIAN SMOOTH
FT0.75X8X142S	178	WOODGRAN SIDING	GP88X29	126	GABLE PEDIMENT VICTORIAN SMOOTH
FT100-12	63	FLAT TRIM SMOOTH	GP96X28	126	GABLE PEDIMENT VICTORIAN SMOOTH
FT101-12	63	FLAT TRIM SMOOTH	GPA104X26	126	GABLE PEDIMENT ARCHED SMOOTH
FT102-10	63	FLAT TRIM SMOOTH	GPA70X35	126	GABLE PEDIMENT ARCHED SMOOTH
FT103-12	63	FLAT TRIM SMOOTH	GPA81X34	126	GABLE PEDIMENT ARCHED SMOOTH
FT109-12	63	FLAT TRIM SMOOTH	GPA86X32	126	GABLE PEDIMENT ARCHED SMOOTH
FT110-12S	177	FLAT TRIM, TIMBER TEXTURE	GPA87X29	126	GABLE PEDIMENT ARCHED SMOOTH
FT110-16	63	FLAT TRIM SMOOTH	GPA95X28	126	GABLE PEDIMENT ARCHED SMOOTH
FT111-12S	177	FLAT TRIM, TIMBER TEXTURE	GPAE108X36X3.5CRS	125	ASHER GABLE PEDIMENTS,WOODGRAIN
FT113-8	63	FLAT TRIM SMOOTH	GPAE108X40.5X3.5CRS	125	ASHER GABLE PEDIMENTS,WOODGRAIN
FT118-8	63	FLAT TRIM SMOOTH	GPAE108X45X3.5CRS	125	ASHER GABLE PEDIMENTS,WOODGRAIN
FT119-17	63	FLAT TRIM SMOOTH	GPAE108X49.5X3.5CRS	125	ASHER GABLE PEDIMENTS,WOODGRAIN
FT122-16	63	FLAT TRIM SMOOTH	GPAE108X54X3.5CRS	125	ASHER GABLE PEDIMENTS,WOODGRAIN

INDEX

Part#	Page	Description	Part#	Page	Description
HRLV48X24FS	97	HALF ROUND LOUVER FUNC,WOODGRAIN	LV12X18FS	98	RECTANGLE VERTICAL LOUVER FUNC,WOODGRAIN
HRLV48X24S	97	HALF ROUND LOUVER DECO,WOODGRAIN	LV12X18S	98	RECTANGLE VERTICAL LOUVER DECO,WOODGRAIN
HRLV60X30	88	HALF ROUND LOUVER DECO SMOOTH	LV12X24	89	RECTANGLE VERTICAL LOUVER DECO SMOOTH
HRLV60X30F	88	LOUVER FUNC HALF ROUND SMOOTH	LV12X24F	89	LOUVER FUNC RECT VERT SMOOTH
HRLV72X36	88	HALF ROUND LOUVER DECO SMOOTH	LV12X24FS	98	RECTANGLE VERTICAL LOUVER FUNC,WOODGRAIN
HRLV72X36F	88	LOUVER FUNC HALF ROUND SMOOTH	LV12X24S	98	RECTANGLE VERTICAL LOUVER DECO,WOODGRAIN
HSP36X18	19	PEDIMENT HALF ROUND SPKD SMOOTH	LV12X30	89	RECTANGLE VERTICAL LOUVER DECO SMOOTH
HSP48X24	19	PEDIMENT HALF ROUND SPKD SMOOTH	LV12X30F	89	LOUVER FUNC RECT VERT SMOOTH
HSP72X36	19	PEDIMENT HALF ROUND SPKD SMOOTH	LV12X30FS	98	RECTANGLE VERTICAL LOUVER FUNC,WOODGRAIN
HSWH100X50	17	PEDIMENT HALF ROUND SUNBURST SMOOTH	LV12X30S	98	RECTANGLE VERTICAL LOUVER DECO,WOODGRAIN
HSWH24X12	17	PEDIMENT HALF ROUND SUNBURST SMOOTH	LV12X36	89	RECTANGLE VERTICAL LOUVER DECO SMOOTH
HSWH28X14	17	PEDIMENT HALF ROUND SUNBURST SMOOTH	LV12X36F	89	LOUVER FUNC RECT VERT SMOOTH
HSWH30X15	17	PEDIMENT HALF ROUND SUNBURST SMOOTH	LV12X40	89	RECTANGLE VERTICAL LOUVER DECO SMOOTH
HSWH32X16	17	PEDIMENT HALF ROUND SUNBURST SMOOTH	LV12X40F	89	LOUVER FUNC RECT VERT SMOOTH
HSWH33X17	17	PEDIMENT HALF ROUND SUNBURST SMOOTH	LV14X27	89	RECTANGLE VERTICAL LOUVER DECO SMOOTH
HSWH36X18	17	PEDIMENT HALF ROUND SUNBURST SMOOTH	LV14X27F	89	LOUVER FUNC RECT VERT SMOOTH
HSWH36X18-4FK	25	PEDIMENT HALF RND SUNBURST W/FLT TRIM & KEY SMOOTH	LV14X27FS	98	RECTANGLE VERTICAL LOUVER FUNC,WOODGRAIN
HSWH36X9	19	PEDIMENT SEGMENT SUNBURST SMOOTH	LV14X27S	98	RECTANGLE VERTICAL LOUVER DECO,WOODGRAIN
HSWH37X19	17	PEDIMENT HALF ROUND SUNBURST SMOOTH	LV14X30	89	RECTANGLE VERTICAL LOUVER DECO SMOOTH
HSWH40X20	17	PEDIMENT HALF ROUND SUNBURST SMOOTH	LV14X30F	89	LOUVER FUNC RECT VERT SMOOTH
HSWH42X21	17	PEDIMENT HALF ROUND SUNBURST SMOOTH	LV14X30FS	98	RECTANGLE VERTICAL LOUVER FUNC,WOODGRAIN
HSWH44X22	17	PEDIMENT HALF ROUND SUNBURST SMOOTH	LV14X30S	98	RECTANGLE VERTICAL LOUVER DECO,WOODGRAIN
HSWH48X13	19	PEDIMENT SEGMENT SUNBURST SMOOTH	LV14X32	89	RECTANGLE VERTICAL LOUVER DECO SMOOTH
HSWH48X24	17	PEDIMENT HALF ROUND SUNBURST SMOOTH	LV14X32F	89	LOUVER FUNC RECT VERT SMOOTH
HSWH56X28	17	PEDIMENT HALF ROUND SUNBURST SMOOTH	LV14X32FS	98	RECTANGLE VERTICAL LOUVER FUNC,WOODGRAIN
HSWH60X30	17	PEDIMENT HALF ROUND SUNBURST SMOOTH	LV14X32S	98	RECTANGLE VERTICAL LOUVER DECO,WOODGRAIN
HSWH64X32	17	PEDIMENT HALF ROUND SUNBURST SMOOTH	LV16X24	89	RECTANGLE VERTICAL LOUVER DECO SMOOTH
HSWH68X14	19	PEDIMENT SEGMENT SUNBURST SMOOTH	LV16X24F	89	LOUVER FUNC RECT VERT SMOOTH
HSWH68X34	17	PEDIMENT HALF ROUND SUNBURST SMOOTH	LV16X24FS	98	RECTANGLE VERTICAL LOUVER FUNC,WOODGRAIN
HSWH72X14	19	PEDIMENT SEGMENT SUNBURST SMOOTH	LV16X24S	98	RECTANGLE VERTICAL LOUVER DECO,WOODGRAIN
HSWH72X36	17	PEDIMENT HALF ROUND SUNBURST SMOOTH	LV16X36	89	RECTANGLE VERTICAL LOUVER DECO SMOOTH
HSWH76X15	19	PEDIMENT SEGMENT SUNBURST SMOOTH	LV16X36F	89	LOUVER FUNC RECT VERT SMOOTH
HSWH76X38	17	PEDIMENT HALF ROUND SUNBURST SMOOTH	LV18X24	89	RECTANGLE VERTICAL LOUVER DECO SMOOTH
HSWH80X15	19	PEDIMENT SEGMENT SUNBURST SMOOTH	LV18X24F	89	LOUVER FUNC RECT VERT SMOOTH
K10S	33	KEystone CROSSHEAD PROFILE SMOOTH	LV18X24FS	98	RECTANGLE VERTICAL LOUVER FUNC,WOODGRAIN
K10TM	33	KEystone TRIM PROFILE SMOOTH	LV18X24S	98	RECTANGLE VERTICAL LOUVER DECO,WOODGRAIN
K12M	33	KEystone CROSSHEAD PROFILE SMOOTH	LV18X24-T	91	LOUVER DECO RECT VRTCL W/TRIM & CRSHD SMOOTH
K180	33	KEystone BRICK MOULD PROFILE SMOOTH	LV18X24TF	91	LOUVER FUNC RECT VERT W/TRIM & CRSHD SMOOTH
K4F	33	KEystone TRIM PROFILE SMOOTH	LV18X30	89	RECTANGLE VERTICAL LOUVER DECO SMOOTH
K4TM	33	KEystone TRIM PROFILE SMOOTH	LV18X30-4F	95	RECTANGLE VERTICAL W/TRIM LOUVER DECO SMOOTH
K6	33	KEystone SOLID SMOOTH	LV18X30F	89	LOUVER FUNC RECT VERT SMOOTH
K6F	33	KEystone TRIM PROFILE SMOOTH	LV18X30FS	98	RECTANGLE VERTICAL LOUVER FUNC,WOODGRAIN
K6M	33	KEystone CROSSHEAD PROFILE SMOOTH	LV18X30S	98	RECTANGLE VERTICAL LOUVER DECO,WOODGRAIN
K6TM	33	KEystone TRIM PROFILE SMOOTH	LV18X36	89	RECTANGLE VERTICAL LOUVER DECO SMOOTH
K8	33	KEystone SOLID SMOOTH	LV18X36F	89	LOUVER FUNC RECT VERT SMOOTH
K8F	33	KEystone TRIM PROFILE SMOOTH	LV18X36FS	98	RECTANGLE VERTICAL LOUVER FUNC,WOODGRAIN
K9M	33	KEystone CROSSHEAD PROFILE SMOOTH	LV18X36S	98	RECTANGLE VERTICAL LOUVER DECO,WOODGRAIN
KP4F	33	KEystone TRIM PROFILE SMOOTH	LV18X42	89	RECTANGLE VERTICAL LOUVER DECO SMOOTH
KP4TM	33	KEystone TRIM PROFILE SMOOTH	LV18X42F	89	LOUVER FUNC RECT VERT SMOOTH
KP6F	33	KEystone TRIM PROFILE SMOOTH	LV20X28	89	RECTANGLE VERTICAL LOUVER DECO SMOOTH
KP6M	33	KEystone CROSSHEAD PROFILE SMOOTH	LV20X28F	89	LOUVER FUNC RECT VERT SMOOTH
KP6TM	33	KEystone TRIM PROFILE SMOOTH	LV20X28FS	98	RECTANGLE VERTICAL LOUVER FUNC,WOODGRAIN
KP9M	33	KEystone CROSSHEAD PROFILE SMOOTH	LV20X28S	98	RECTANGLE VERTICAL LOUVER DECO,WOODGRAIN
LP6X96	161	LAMP POST TAPERED SMOOTH	LV20X30FS	98	RECTANGLE VERTICAL LOUVER FUNC,WOODGRAIN
LV12X18	89	RECTANGLE VERTICAL LOUVER DECO SMOOTH	LV20X30S	98	RECTANGLE VERTICAL LOUVER DECO,WOODGRAIN
LV12X18F	89	LOUVER FUNC RECT VERT SMOOTH	LV24X24	89	RECTANGLE VERTICAL LOUVER DECO SMOOTH

INDEX

Part#	Page	Description	Part#	Page	Description
LV24X24F	89	LOUVER FUNC RECT VERT SMOOTH	LVSTCR18X72	35	SHUTTER LOUVERED W/CENTER RAIL SMOOTH
LV24X24FS	98	RECTANGLE VERTICAL LOUVER FUNC,WOODGRAIN	LVSTCR24X60	35	SHUTTER LOUVERED W/CENTER RAIL SMOOTH
LV24X24S	98	RECTANGLE VERTICAL LOUVER DECO,WOODGRAIN	LVSTCR24X72	35	SHUTTER LOUVERED W/CENTER RAIL SMOOTH
LV24X30	89	RECTANGLE VERTICAL LOUVER DECO SMOOTH	LVSTCRK14.5X60KS	60	WOODGRAIN PANEL SHUTTER WITH BORDER-OAK
LV24X30F	89	LOUVER FUNC RECT VERT SMOOTH	MD1001-12	65	MOULDING CROWN SMOOTH
LV24X30FS	98	RECTANGLE VERTICAL LOUVER FUNC,WOODGRAIN	MD1002-12	65	MOULDING CROWN SMOOTH
LV24X30S	98	RECTANGLE VERTICAL LOUVER DECO,WOODGRAIN	MD1019-12	65	MOULDING BASE TRIM SMOOTH
LV24X36	89	RECTANGLE VERTICAL LOUVER DECO SMOOTH	MD1020-12	65	MOULDING BASE TRIM SMOOTH
LV24X36F	89	LOUVER FUNC RECT VERT SMOOTH	MD1037-12	65	MOULDING CROWN SMOOTH
LV24X36FS	98	RECTANGLE VERTICAL LOUVER FUNC,WOODGRAIN	MD2.4X2.4X102S-IC	179	WOODGRAIN SIDING INSIDE CORNER
LV24X36S	98	RECTANGLE VERTICAL LOUVER DECO,WOODGRAIN	MD2.4X2.4X102S-OC	179	WOODGRAIN SIDING OUTSIDE CORNER
LV24X48	89	RECTANGLE VERTICAL LOUVER DECO SMOOTH	MD205-12	65	MOULDING W&D CASING SMOOTH
LV24X48F	89	LOUVER FUNC RECT VERT SMOOTH	MD205-8	65	MOULDING W&D CASING SMOOTH
LV27X17	91	RECTANGLE VERTICAL LOUVER DECO SMOOTH	MD207-16	65	MOULDING W&D CASING FLUTED SMOOTH
LV27X17F	91	LOUVER FUNC RECT VERT SMOOTH	MD208-16	65	MOULDING W&D CASING FLUTED SMOOTH
LV30X42	89	RECTANGLE VERTICAL LOUVER DECO SMOOTH	MD214-12	65	MOULDING W&D CASING SMOOTH
LV30X42F	89	LOUVER FUNC RECT VERT SMOOTH	MD215-12	65	MOULDING W&D CASING SMOOTH
LV32X16	91	RECTANGLE VERTICAL LOUVER DECO SMOOTH	MD220-12	65	MOULDING W&D CASING SMOOTH
LV32X16F	91	LOUVER FUNC RECT VERT SMOOTH	MD220-16	65	MOULDING W&D CASING SMOOTH
LV8X15	89	RECTANGLE VERTICAL LOUVER DECO SMOOTH	MD221-16	65	MOULDING W&D CASING SMOOTH
LV8X15F	89	LOUVER FUNC RECT VERT SMOOTH	MD224-12	65	MOULDING W&D CASING SMOOTH
LV8X24	89	RECTANGLE VERTICAL LOUVER DECO SMOOTH	MD226-10	65	MOULDING W&D CASING SMOOTH
LV8X24F	89	LOUVER FUNC RECT VERT SMOOTH	MD226-12	65	MOULDING W&D CASING SMOOTH
LV8X30	89	RECTANGLE VERTICAL LOUVER DECO SMOOTH	MD226-16	65	MOULDING W&D CASING SMOOTH
LV8X30F	89	LOUVER FUNC RECT VERT SMOOTH	MD227-16	66	MOULDING W&D CASING SMOOTH
LVNT18X24	91	RECTANGLE VERTICAL NO SILL LOUVER DECO SMOOTH	MD230-12	66	MOULDING W&D CASING SMOOTH
LVST16X54	35	SHUTTER LOUVERED SMOOTH	MD230-16	66	MOULDING W&D CASING SMOOTH
LVST16X72	35	SHUTTER LOUVERED SMOOTH	MD231-12	66	MOULDING W&D CASING SMOOTH
LVST18X54	35	SHUTTER LOUVERED SMOOTH	MD234-16	66	MOULDING W&D CASING SMOOTH
LVST18X60	35	SHUTTER LOUVERED SMOOTH	MD236-16	66	MOULDING W&D CASING SMOOTH
LVST18X72	35	SHUTTER LOUVERED SMOOTH	MD237-16	66	MOULDING W&D CASING SMOOTH
LVST24X60	35	SHUTTER LOUVERED SMOOTH	MD240-8	66	MOULDING CORNICE SMOOTH
LVST24X72	35	SHUTTER LOUVERED SMOOTH	MD246-16	66	MOULDING FASCIA SMOOTH
LVSTCR12X36	35	SHUTTER LOUVERED W/CENTER RAIL SMOOTH	MD247-16	66	MOULDING BASE TRIM SMOOTH
LVSTCR12X39KS-C	54	LOUVERED SHUTTER WOODGRAIN	MD250-12	66	MOULDING W&D CASING SMOOTH
LVSTCR12X46KS-C	54	LOUVERED SHUTTER WOODGRAIN	MD250-8	66	MOULDING W&D CASING SMOOTH
LVSTCR12X48	35	SHUTTER LOUVERED W/CENTER RAIL SMOOTH	MD253-16	66	MOULDING CROWN FASCIA SMOOTH
LVSTCR12X48KS	53	PANEL SHUTTER WITH BORDER,CEDER WOODGRAIN	MD303-5	66	MOULDING DENTIL SMOOTH
LVSTCR12X60KS-C	54	LOUVERED SHUTTER WOODGRAIN	MD304-8	67	MOULDING DENTIL SMOOTH
LVSTCR14.5X39KS	54	LOUVERED SHUTTER WOODGRAIN	MD310-12	67	MOULDING DENTIL SMOOTH
LVSTCR14.5X46KS	54	LOUVERED SHUTTER WOODGRAIN	MD310-16	67	MOULDING DENTIL SMOOTH
LVSTCR14.5X47KS	54	LOUVERED SHUTTER WOODGRAIN	MD310-8	67	MOULDING DENTIL SMOOTH
LVSTCR14.5X48KS	54	LOUVERED SHUTTER WOODGRAIN	MD311-16	67	MOULDING CORNICE SMOOTH
LVSTCR14.5X59KS-C	54	LOUVERED SHUTTER WOODGRAIN	MD313-8	67	MOULDING DENTIL SMOOTH
LVSTCR14.5X60KS-C	54	LOUVERED SHUTTER WOODGRAIN	MD320-12	67	MOULDING DENTIL SMOOTH
LVSTCR14.5X80KS-C	54	LOUVERED SHUTTER WOODGRAIN	MD320-16	67	MOULDING DENTIL SMOOTH
LVSTCR16X48KS	53	PANEL SHUTTER WITH BORDER,CEDER WOODGRAIN	MD320-8	67	MOULDING DENTIL SMOOTH
LVSTCR16X54	35	SHUTTER LOUVERED W/CENTER RAIL SMOOTH	MD330-12	67	MOULDING DENTIL SMOOTH
LVSTCR16X60	35	SHUTTER LOUVERED W/CENTER RAIL SMOOTH	MD331-16	67	MOULDING DENTIL SMOOTH
LVSTCR16X60KS	53	PANEL SHUTTER WITH BORDER,CEDER WOODGRAIN	MD332-8	67	MOULDING DENTIL SMOOTH
LVSTCR16X65KS	53	PANEL SHUTTER WITH BORDER,CEDER WOODGRAIN	MD333-12	67	MOULDING DENTIL SMOOTH
LVSTCR16X72	35	SHUTTER LOUVERED W/CENTER RAIL SMOOTH	MD335-12	67	MOULDING DENTIL SMOOTH
LVSTCR18X48KS	53	PANEL SHUTTER WITH BORDER,CEDER WOODGRAIN	MD336-16	67	MOULDING DENTIL SMOOTH
LVSTCR18X60	35	SHUTTER LOUVERED W/CENTER RAIL SMOOTH	MD350-8	67	MOULDING DENTIL SMOOTH
LVSTCR18X60KS	53	PANEL SHUTTER WITH BORDER,CEDER WOODGRAIN	MD351-8	68	MOULDING DENTIL SMOOTH
LVSTCR18X66	35	SHUTTER LOUVERED W/CENTER RAIL SMOOTH	MD352-8	68	MOULDING DENTIL SMOOTH

Part#	Page	Description	Part#	Page	Description
MD353-8	68	MOULDING DENTIL SMOOTH	MD535-16	74	MOULDING CROWN SMOOTH
MD354-12	68	MOULDING DENTIL SMOOTH	MD536-12	74	MOULDING CROWN FASCIA SMOOTH
MD355-8	68	MOULDING DENTIL SMOOTH	MD539-16	74	MOULDING CROWN FASCIA SMOOTH
MD360-8	68	MOULDING DENTIL SMOOTH	MD543-12	74	MOULDING FASCIA SMOOTH
MD362-16	68	MOULDING DENTIL SMOOTH	MD545-12	76	MOULDING CORNICE SMOOTH
MD365-16	68	MOULDING DENTIL SMOOTH	MD547-16	76	MOULDING CORNICE SMOOTH
MD370-8	68	MOULDING DENTIL SMOOTH	MD548-16	76	MOULDING FASCIA SMOOTH
MD371-16	68	MOULDING CROWN FASCIA SMOOTH	MD552-12	76	MOULDING CROWN FASCIA SMOOTH
MD404-12	68	MOULDING CROWN SMOOTH	MD555-12	76	MOULDING CROWN SMOOTH
MD404-16	68	MOULDING CROWN SMOOTH	MD556-16	76	MOULDING CROWN FASCIA SMOOTH
MD406-16	68	MOULDING CROWN SMOOTH	MD562-8	76	MOULDING CROWN SMOOTH
MD410-12	70	MOULDING CROWN SMOOTH	MD569-12	76	MOULDING CROWN FASCIA SMOOTH
MD411-16	70	MOULDING CROWN SMOOTH	MD570-12	76	MOULDING CROWN FASCIA SMOOTH
MD412-16	70	MOULDING CROWN SMOOTH	MD572-16	76	MOULDING CROWN SMOOTH
MD413-12	70	MOULDING CROWN SMOOTH	MD580-12	76	MOULDING CROWN FASCIA SMOOTH
MD419-12	70	MOULDING CROWN SMOOTH	MD582-12	76	MOULDING CROWN SMOOTH
MD421-12	70	MOULDING CROWN SMOOTH	MD583-16	78	MOULDING COVE SMOOTH
MD425-12	70	MOULDING CROWN SMOOTH	MD584-16	78	MOULDING COVE SMOOTH
MD430-12	70	MOULDING CROWN SMOOTH	MD585-12	78	MOULDING CROWN FASCIA SMOOTH
MD434-16	70	MOULDING DENTIL SMOOTH	MD586-16	78	MOULDING CROWN FASCIA SMOOTH
MD435-16	70	MOULDING CROWN SMOOTH	MD587-16	78	MOULDING CROWN FASCIA SMOOTH
MD440-12	70	MOULDING CROWN SMOOTH	MD588-16	78	MOULDING COVE SMOOTH
MD449-16	70	MOULDING CROWN SMOOTH	MD589-16	78	MOULDING COVE SMOOTH
MD450-16	71	MOULDING CROWN SMOOTH	MD590-16	78	MOULDING COVE SMOOTH
MD451-16	71	MOULDING CROWN SMOOTH	MD591-16	78	MOULDING COVE SMOOTH
MD452-12	71	MOULDING CROWN SMOOTH	MD592-16	78	MOULDING COVE SMOOTH
MD453-16	71	MOULDING CROWN SMOOTH	MD593-16	78	MOULDING COVE SMOOTH
MD454-12	71	MOULDING CROWN SMOOTH	MD6.35X4-10	83	BATTEN WOODGRAIN
MD456-16	71	MOULDING CROWN SMOOTH	MD600-10	78	MOULDING FASCIA SMOOTH
MD457-12	71	MOULDING CROWN SMOOTH	MD601-12	79	MOULDING OGEE SMOOTH
MD460-12	71	MOULDING CROWN SMOOTH	MD602-8	79	MOULDING OGEE CROSSHEAD TRIM STRIP SMOOTH
MD461-8	71	MOULDING CROWN SMOOTH	MD603-8	79	MOULDING QUARTER ROUND SMOOTH
MD467-16	71	MOULDING CROWN SMOOTH	MD605-12	79	MOULDING HALF ROUND SMOOTH
MD472-12	71	MOULDING CROWN SMOOTH	MD606-12	79	MOULDING COVE SMOOTH
MD481-12	71	MOULDING CROWN SMOOTH	MD607-8	79	MOULDING CORNER STRIP SMOOTH
MD490-12	72	MOULDING CROWN SMOOTH	MD610-8	79	MOULDING CHAIR RAIL SMOOTH
MD4X2-10	83	BATTEN WOODGRAIN	MD611-12	79	MOULDING CHAIR RAIL SMOOTH
MD505-8	72	MOULDING FASCIA SMOOTH	MD612-12	79	MOULDING CHAIR RAIL SMOOTH
MD506-16	72	MOULDING FASCIA SMOOTH	MD613-12	79	MOULDING BED MOULDING SMOOTH
MD508-12	72	MOULDING FASCIA SMOOTH	MD613-16	79	MOULDING BED MOULDING SMOOTH
MD509-16	72	MOULDING CORNICE SMOOTH	MD614-16	79	MOULDING CHAIR RAIL SMOOTH
MD510-12	72	MOULDING CORNICE SMOOTH	MD618-16	79	MOULDING BASE CAP SMOOTH
MD511-12	72	MOULDING CORNICE SMOOTH	MD621-16	80	MOULDING SHINGLE SMOOTH
MD512-16	72	MOULDING CORNICE SMOOTH	MD625-16	80	MOULDING STEP SMOOTH
MD513-16	72	MOULDING FASCIA SMOOTH	MD626-8	80	MOULDING BED MOULDING SMOOTH
MD520-16	72	MOULDING CORNICE SMOOTH	MD627-16	80	MOULDING CHAIR RAIL SMOOTH
MD521-8	72	MOULDING FASCIA SMOOTH	MD628-8	80	MOULDING COVE SMOOTH
MD522-16	72	MOULDING FASCIA SMOOTH	MD629-10	80	MOULDING BED MOULDING SMOOTH
MD523-16	74	MOULDING FASCIA SMOOTH	MD631-16	80	MOULDING CHAIR RAIL SMOOTH
MD524-16	74	MOULDING CROWN FASCIA SMOOTH	MD633-8	80	MOULDING OGEE SMOOTH
MD527-16	74	MOULDING CORNICE SMOOTH	MD634-16	80	MOULDING OGEE SMOOTH
MD528-12	74	MOULDING CROWN SMOOTH	MD635-12	80	MOULDING COVE SMOOTH
MD530-8	74	MOULDING FASCIA SMOOTH	MD637-16	80	MOULDING ASTRAGAL/MULLION SMOOTH
MD531-8	74	MOULDING FASCIA SMOOTH	MD639-16	80	MOULDING FASCIA SMOOTH
MD533-12	74	MOULDING FASCIA SMOOTH	MD640-8	82	MOULDING FASCIA SMOOTH
MD534-12	74	MOULDING CORNICE SMOOTH	MD641-16	82	MOULDING CORNICE SMOOTH

INDEX

Part#	Page	Description	Part#	Page	Description
MD642-12	82	MOULDING CROWN SMOOTH	OVB25X37F-TS	97	OVAL VERTICAL LOUVER DECO, WOODGRAIN
MD644-16	82	MOULDING FASCIA SMOOTH	OVB28X35F-T	95	LOUVER FUNC OVAL VERT W/ DC TRIM & KEY SMOOTH
MD649-16	82	MOULDING BED MOULDING SMOOTH	OVB28X35-T	95	LOUVER DECO OVAL VRTCL W/ DC TRIM & KEY SMOOTH
MD660-10	82	MOULDING COVE SMOOTH	OVB29X20FTK	94	LOUVER DECO OVAL HORZ W/TRIM & KEY SMOOTH
MD705-16	82	MOULDING FLAT TRIM PROFILES COVE SMOOTH	OVB35X28F-T	95	LOUVER FUNC OVAL HORZ W/ DC TRIM & KEY SMOOTH
MD706-16	82	MOULDING BASE TRIM SMOOTH	OVB35X28-T	95	LOUVER DECO OVAL HORZ W/ DC TRIM & KEY SMOOTH
MD710-10	82	MOULDING SILL SMOOTH	PAPE5X11	159	FINIAL FULL RND PINEAPPLE SMOOTH
MD715-16	82	MOULDING FLAT TRIM PROFILES BEADED SMOOTH	PAPE6X14	159	FINIAL FULL RND PINEAPPLE SMOOTH
MD716-12	82	MOULDING, BOTTOM TRIM DISTINCTION CROSSHEAD 6"	PB2.5X2.5	64	PLINTH BLOCK ROSETTE SMOOTH
MD730-8	82	MOULDING OGEE SMOOTH	PB3.5X3.5	64	PLINTH BLOCK ROSETTE SMOOTH
MD734-12	82	MOULDING COVE SMOOTH	PB3.875X3.875	64	PLINTH BLOCK ROSETTE SMOOTH
MD758-12	82	MOULDING, BOTTOM TRIM DISTINCTION CROSSHEAD 9"	PB3X3	64	PLINTH BLOCK ROSETTE SMOOTH
MD901-16	83	MOULDING COVE SMOOTH	PB4X4	64	PLINTH BLOCK ROSETTE SMOOTH
MD902-16	83	MOULDING COVE SMOOTH	PB5X5	64	PLINTH BLOCK ROSETTE SMOOTH
MD903-16	83	MOULDING COVE SMOOTH	PB6X6	64	PLINTH BLOCK ROSETTE SMOOTH
MDWM180-16	64	BRICKMOULD SMOOTH	PCP56	21	PEDIMENT PEAKED CAP SMOOTH
MDWM180-8S	64	BRICKMOULD WOODGRAIN	PCP667	21	PEDIMENT PEAKED CAP SMOOTH
MDWM182-12	64	BRICKMOULD SMOOTH	PH6X14	129	PINEAPPLE-HALF ROUND,SMOOTH
NCP8X48	157	CORNER PANEL NEWEL POST SMOOTH	PK400	157	NEWEL POST INSTALL KIT SMOOTH
NP6X48	157	NEWEL POST PLAIN SMOOTH	PK600	157	NEWEL POST INSTALL KIT SMOOTH
NP8X48	157	NEWEL POST PLAIN SMOOTH	PL10X120P	30	PILASTER PLAIN ADJ PLTH SMOOTH
NPT10X10	158	NEWEL POST FLAT POST CAP SMOOTH	PL10X192A	28	PILASTER ARCH PROF SMOOTH
NPT6X6P	158	NEWEL POST FANCY PEAKED POST CAP SMOOTH	PL10X96A	28	PILASTER ARCH PROF SMOOTH
NPT7X7	158	NEWEL POST FLAT POST CAP SMOOTH	PL10X96HC	27	PILASTER HALF RND ADJ CLM SMOOTH
NPT7X7P	158	NEWEL POST FANCY PEAKED POST CAP SMOOTH	PL11X108	29	PILASTER FLUTED ADJ PLTH SMOOTH
NPT8X8P	158	NEWEL POST FANCY PEAKED POST CAP SMOOTH	PL11X108DP	27	PILASTER DOUBLE PANEL MLD PLTH SMOOTH
NPT9X9P	158	NEWEL POST FANCY PEAKED POST CAP SMOOTH	PL11X108P	30	PILASTER PLAIN ADJ PLTH SMOOTH
NSLV18X24F	91	LOUVER FUNC RECT VERT NO SILL SMOOTH	PL11X120	29	PILASTER FLUTED ADJ PLTH SMOOTH
NSP8X48	157	STRAIGHT PANEL NEWEL POST SMOOTH	PL11X120P	30	PILASTER PLAIN ADJ PLTH SMOOTH
OLV18X24	91	OVAL VERTICAL LOUVER DECO SMOOTH	PL11X144	29	PILASTER FLUTED ADJ PLTH SMOOTH
OLV18X24S	97	OVAL VERTICAL LOUVER DECO, WOODGRAIN	PL11X90	29	PILASTER FLUTED MLD PLTH SMOOTH
OLV25X37	91	OVAL VERTICAL LOUVER DECO SMOOTH	PL11X90DP	27	PILASTER DOUBLE PANEL MLD PLTH SMOOTH
OLV25X37S	97	OVAL VERTICAL LOUVER DECO, WOODGRAIN	PL11X90P	30	PILASTER PLAIN MLD PLTH SMOOTH
OVA18	95	OCTAGON LOUVER DECO SMOOTH	PL11X96P	30	PILASTER PLAIN ADJ PLTH SMOOTH
OVA18F	95	LOUVER FUNC OCTAGON SMOOTH	PL3X108	29	PILASTER FLUTED ADJ PLTH SMOOTH
OVA18FS	99	OCTAGON LOUVER FUNC,WOODGRAIN	PL4X108	29	PILASTER FLUTED ADJ PLTH SMOOTH
OVA18S	99	OCTAGON LOUVER DECO,WOODGRAIN	PL5X108	29	PILASTER FLUTED ADJ PLTH SMOOTH
OVA22	95	OCTAGON LOUVER DECO SMOOTH	PL5X108P	30	PILASTER PLAIN ADJ PLTH SMOOTH
OVA22F	95	LOUVER FUNC OCTAGON SMOOTH	PL5X120E	28	PILASTER FLUTED ECO ADJ PLTH SMOOTH
OVA22FS	99	OCTAGON LOUVER FUNC,WOODGRAIN	PL5X90DP	27	PILASTER DOUBLE PANEL MLD PLTH SMOOTH
OVA22S	99	OCTAGON LOUVER DECO,WOODGRAIN	PL5X90E	28	PILASTER FLUTED ECO MLD PLTH SMOOTH
OVA24	95	OCTAGON LOUVER DECO SMOOTH	PL5X90P	30	PILASTER PLAIN MLD PLTH SMOOTH
OVA24F	95	LOUVER FUNC OCTAGON SMOOTH	PL6X108	29	PILASTER FLUTED ADJ PLTH SMOOTH
OVA24FS	99	OCTAGON LOUVER FUNC,WOODGRAIN	PL6X120P	30	PILASTER PLAIN ADJ PLTH SMOOTH
OVA24S	99	OCTAGON LOUVER DECO,WOODGRAIN	PL6X144	29	PILASTER FLUTED ADJ PLTH SMOOTH
OVA28	95	OCTAGON LOUVER DECO SMOOTH	PL6X90	29	PILASTER FLUTED MLD PLTH SMOOTH
OVA28F	95	LOUVER FUNC OCTAGON SMOOTH	PL6X90P	30	PILASTER PLAIN MLD PLTH SMOOTH
OVA28FS	99	OCTAGON LOUVER FUNC,WOODGRAIN	PL7X102	29	PILASTER FLUTED ADJ PLTH SMOOTH
OVA28S	99	OCTAGON LOUVER DECO,WOODGRAIN	PL7X104DP	27	PLASTER DOUBLE PANEL MLD PLTH SMOOTH
OVB18X24F-T	91	LOUVER FUNC OVAL VERT SMOOTH	PL7X108	29	PILASTER FLUTED ADJ PLTH SMOOTH
OVB18X24F-TS	97	OVAL VERTICAL LOUVER DECO, WOODGRAIN	PL7X108P	30	PILASTER PLAIN ADJ PLTH SMOOTH
OVB20X29F-T	94	LOUVER FUNC OVAL VERT W/ FL TRIM & KEY SMOOTH	PL7X120P	30	PILASTER PLAIN ADJ PLTH SMOOTH
OVB20X29FTK	94	LOUVER DECO OVAL VRTCL W/ FL TRIM & KEY SMOOTH	PL7X144	29	PILASTER FLUTED ADJ PLTH SMOOTH
OVB24X36X4F	32	TRIM OVAL FLAT SMOOTH	PL7X90	29	PILASTER FLUTED MLD PLTH SMOOTH
OVB24X36X4M	32	TRIM OVAL DECORATIVE SMOOTH	PL7X90DP	27	PILASTER DOUBLE PANEL MLD PLTH SMOOTH
OVB25X37F-T	91	LOUVER FUNC OVAL VERT SMOOTH	PL7X90DPE	27	PILASTER DOUBLE PANEL ECO MLD PLTH SMOOTH

INDEX

Part#	Page	Description	Part#	Page	Description
PL7X90E	28	PILASTER FLUTED ECO MLD PLTH SMOOTH	RLV18FS	97	LOUVER FUNC ROUND,WOODGRAIN
PL7X90P	30	PILASTER PLAIN MLD PLTH SMOOTH	RLV18MTK	90	LOUVER DECO ROUND W/ DC TRIM & KEY SMOOTH
PL8X108	29	PILASTER FLUTED ADJ PLTH SMOOTH	RLV18S	97	LOUVER DECO ROUND,WOODGRAIN
PL8X108P	30	PILASTER PLAIN ADJ PLTH SMOOTH	RLV18X4F	93	TRIM ROUND SMOOTH
PL8X144	29	PILASTER FLUTED ADJ PLTH SMOOTH	RLV22	93	LOUVER DECO ROUND SMOOTH
PL8X90	29	PILASTER FLUTED ADJ PLTH SMOOTH	RLV22F	93	LOUVER FUNC ROUND SMOOTH
PL8X90P	30	PILASTER PLAIN MLD PLTH SMOOTH	RLV22FS	97	LOUVER FUNC ROUND,WOODGRAIN
PL9X100DP	27	PILASTER DOUBLE PANEL MLD PLTH SMOOTH	RLV22S	97	LOUVER DECO ROUND,WOODGRAIN
PL9X102	29	PILASTER FLUTED ADJ PLTH SMOOTH	RLV24	93	LOUVER DECO ROUND SMOOTH
PL9X108	29	PILASTER FLUTED ADJ PLTH SMOOTH	RLV24-4FTK	90	LOUVER DECO ROUND W/ FL TRIM & KEY SMOOTH
PL9X108P	30	PILASTER PLAIN ADJ PLTH SMOOTH	RLV24-6TK	90	LOUVER FUNC ROUND W/ FL TRIM & FLAT KEY SMOOTH
PL9X120P	30	PILASTER PLAIN ADJ PLTH SMOOTH	RLV24F	93	LOUVER FUNC ROUND SMOOTH
PL9X144	29	PILASTER FLUTED ADJ PLTH SMOOTH	RLV24F-4FTK	90	LOUVER FUNC ROUND W/ DC TRIM & KEY SMOOTH
PL9X90	29	PILASTER FLUTED MLD PLTH SMOOTH	RLV24F-6TK	90	LOUVER FUNC ROUND W/ FL TRIM & FLAT KEY SMOOTH
PL9X90DP	27	PILASTER DOUBLE PANEL MLD PLTH SMOOTH	RLV24F-FTK	94	LOUVER FUNC ROUND W/ FL TRIM & FLAT KEY SMOOTH
PL9X90E	28	PILASTER FLUTED ECO MLD PLTH SMOOTH	RLV24F-FTKS	99	LOUVER FUNC ROUND W/ DC TRIM & KEY,WOODGRAIN
PL9X90P	30	PILASTER PLAIN MLD PLTH SMOOTH	RLV24F-MTK	90	LOUVER FUNC ROUND W/ DC TRIM & KEY SMOOTH
PLV18X24-8	88	PEAKED LOUVER DECO SMOOTH	RLV24FS	97	LOUVER FUNC ROUND,WOODGRAIN
PLV18X24F-8	88	LOUVER FUNC PEAKED SMOOTH	RLV24FTK	94	LOUVER DECO ROUND W/ FL TRIM & KEY SMOOTH
PLV18X36-10	88	PEAKED LOUVER DECO SMOOTH	RLV24FTKS	99	LOUVER DECO ROUND W/ FL TRIM & KEY,WOODGRAIN
PLV18X36F-10	88	LOUVER FUNC PEAKED SMOOTH	RLV24MTK	90	LOUVER DECO ROUND W/ DC TRIM & KEY SMOOTH
PLV24X30-10	88	PEAKED LOUVER DECO SMOOTH	RLV24S	97	LOUVER DECO ROUND,WOODGRAIN
PLV24X30F-10	88	LOUVER FUNC PEAKED SMOOTH	RLV24X4F	93	TRIM ROUND SMOOTH
PLV24X36-10	88	PEAKED LOUVER DECO SMOOTH	RLV28	93	LOUVER DECO ROUND SMOOTH
PLV24X36-12	88	PEAKED LOUVER DECO SMOOTH	RLV28F	93	LOUVER FUNC ROUND SMOOTH
PLV24X36F-10	88	LOUVER FUNC PEAKED SMOOTH	RLV28FS	97	LOUVER FUNC ROUND,WOODGRAIN
PLV24X36F-12	88	LOUVER FUNC PEAKED SMOOTH	RLV28S	97	LOUVER DECO ROUND,WOODGRAIN
PP6X108	160	PORCH POST COLONIAL SMOOTH	RLV28X4F	93	TRIM ROUND SMOOTH
PP6X120	160	PORCH POST COLONIAL SMOOTH	RLV30	93	LOUVER DECO ROUND SMOOTH
PP6X96	160	PORCH POST COLONIAL SMOOTH	RLV30-6TK	90	LOUVER DECO ROUND W/ FL TRIM & KEY SMOOTH
PP8X120A	160	PORCH POST COLONIAL SMOOTH	RLV30F	93	LOUVER FUNC ROUND SMOOTH
PRS48X8	128	PORCH SPANDREL SMOOTH	RLV30F-6TK	90	LOUVER FUNC ROUND W/ FL TRIM & FLAT KEY SMOOTH
PRS96X8	128	PORCH SPANDREL SMOOTH	RLV30F-FTK	94	LOUVER FUNC ROUND W/ FL TRIM & FLAT KEY SMOOTH
QNI6X96	129	QUOIN	RLV30F-FTKS	99	LOUVER FUNC ROUND W/ DC TRIM & KEY,WOODGRAIN
RF-C0640	181	ADHESIVE	RLV30F-MTK	90	LOUVER FUNC ROUND W/ DC TRIM & KEY SMOOTH
RHP54	16	PEDIMENT COMBO RAMS HEAD SMOOTH	RLV30FS	97	LOUVER FUNC ROUND,WOODGRAIN
RHP54BT	16	PEDIMENT COMBO RAMS HEAD W/BT SMOOTH	RLV30FTK	94	LOUVER DECO ROUND W/ FL TRIM & KEY SMOOTH
RHP67	16	PEDIMENT COMBO RAMS HEAD SMOOTH	RLV30FTKS	99	LOUVER DECO ROUND W/ FL TRIM & KEY,WOODGRAIN
RHP67BT	16	PEDIMENT COMBO RAMS HEAD W/BT SMOOTH	RLV30MTK	90	LOUVER DECO ROUND W/ DC TRIM & KEY SMOOTH
RHP75	16	PEDIMENT COMBO RAMS HEAD SMOOTH	RLV30S	97	LOUVER DECO ROUND,WOODGRAIN
RHP75BT	16	PEDIMENT COMBO RAMS HEAD W/BT SMOOTH	RLV32-2F	94	LOUVER DECO ROUND W/ FL TRIM SMOOTH
RHP80	16	PEDIMENT COMBO RAMS HEAD SMOOTH	RLV32F-2F	94	LOUVER FUNC ROUND W/ FL TRIM SMOOTH
RHP80BT	16	PEDIMENT COMBO RAMS HEAD W/BT SMOOTH	RLV32F-FTK	94	LOUVER FUNC ROUND W/ FL TRIM & KEY SMOOTH
RHP85	16	PEDIMENT COMBO RAMS HEAD SMOOTH	RLV32F-FTKS	99	LOUVER FUNC ROUND W/ DC TRIM & KEY,WOODGRAIN
RHP85BT	16	PEDIMENT COMBO RAMS HEAD W/BT SMOOTH	RLV32F-MTK	90	LOUVER FUNC ROUND W/ DC TRIM & KEY SMOOTH
RLV12	93	LOUVER DECO ROUND SMOOTH	RLV32FTK	94	LOUVER DECO ROUND W/ FL TRIM & KEY SMOOTH
RLV12F	93	LOUVER FUNC ROUND SMOOTH	RLV32FTKS	99	LOUVER DECO ROUND W/ FL TRIM & KEY,WOODGRAIN
RLV16	93	LOUVER DECO ROUND SMOOTH	RLV32MTK	90	LOUVER DECO ROUND W/ DC TRIM & KEY SMOOTH
RLV16F	93	LOUVER FUNC ROUND SMOOTH	RLV36	93	LOUVER DECO ROUND SMOOTH
RLV16F-MTK	90	LOUVER FUNC ROUND W/ DC TRIM & KEY SMOOTH	RLV36F	93	LOUVER FUNC ROUND SMOOTH
RLV16FS	97	LOUVER FUNC ROUND,WOODGRAIN	RLV36F-FTK	94	LOUVER FUNC ROUND W/ FL TRIM & FK SMOOTH
RLV16MTK	90	LOUVER DECO ROUND W/ DC TRIM & KEY SMOOTH	RLV36F-FTKS	99	LOUVER FUNC ROUND W/ DC TRIM & KEY,WOODGRAIN
RLV16S	97	LOUVER DECO ROUND,WOODGRAIN	RLV36FS	97	LOUVER FUNC ROUND,WOODGRAIN
RLV18	93	LOUVER DECO ROUND SMOOTH	RLV36FTK	94	LOUVER DECO ROUND W/ FL TRIM & KEY SMOOTH
RLV18F	93	LOUVER FUNC ROUND SMOOTH	RLV36FTKS	99	LOUVER DECO ROUND W/ FL TRIM & KEY,WOODGRAIN
RLV18F-MTK	90	LOUVER FUNC ROUND W/ DC TRIM & KEY SMOOTH	RLV36S	97	LOUVER DECO ROUND,WOODGRAIN

INDEX

Part#	Page	Description	Part#	Page	Description
RLV40F-MTK	90	LOUVER FUNC ROUND W/ DC TRIM & KEY SMOOTH	ST2P2T12X48CRS-G	43	SHUTTER 2 PLANK, ROUGH SAWN WOODGRAIN
RLV40MTK	90	LOUVER DECO ROUND W/ DC TRIM & KEY SMOOTH	ST2P2T12X60CRS	39	SHUTTER 2 BOARD AND BATTEN, ROUGH SAWN WOODGRAIN
RLV42	93	LOUVER DECO ROUND SMOOTH	ST2P2T12X60CRS-D	46	SHUTTER 2 PLANK W/DIAMOND, ROUGH SAWN WOODGRAIN
RLV42F	93	LOUVER FUNC ROUND SMOOTH	ST2P2T12X60CRS-G	43	SHUTTER 2 PLANK, ROUGH SAWN WOODGRAIN
RLV48	93	LOUVER DECO ROUND SMOOTH	ST2P2T12X72CRS	39	SHUTTER 2 BOARD AND BATTEN, ROUGH SAWN WOODGRAIN
RLV48F	93	LOUVER FUNC ROUND SMOOTH	ST2P2T12X72CRS-D	46	SHUTTER 2 PLANK W/DIAMOND, ROUGH SAWN WOODGRAIN
RS2X4X6	153	BAULSTER RAIL SUPPORT BLOCK SMOOTH	ST2P2T12X72CRS-G	43	SHUTTER 2 PLANK, ROUGH SAWN WOODGRAIN
RS4X4X6	153	BAULSTER RAIL SUPPORT BLOCK SMOOTH	ST2P2T12X84CRS	39	SHUTTER 2 BOARD AND BATTEN, ROUGH SAWN WOODGRAIN
S4X21	159	SPIRE SMOOTH	ST2P2T12X84CRS-D	46	SHUTTER 2 PLANK W/DIAMOND, ROUGH SAWN WOODGRAIN
S6X32	159	SPIRE SMOOTH	ST2P2T12X84CRS-G	43	SHUTTER 2 PLANK, ROUGH SAWN WOODGRAIN
S8X56	159	SPIRE SMOOTH	ST2P2T12X96CRS	39	SHUTTER 2 BOARD AND BATTEN, ROUGH SAWN WOODGRAIN
SAP36	20	PEDIMENT COMBO SGMT ARCH SMOOTH	ST2P2T12X96CRS-D	46	SHUTTER 2 PLANK W/DIAMOND, ROUGH SAWN WOODGRAIN
SAP36BT	20	PEDIMENT COMBO SGMT ARCH W/BT SMOOTH	ST2P2T12X96CRS-G	43	SHUTTER 2 PLANK, ROUGH SAWN WOODGRAIN
SAP48	20	PEDIMENT COMBO SGMT ARCH SMOOTH	ST2P3T12X108CRS	39	SHUTTER 2 BOARD AND 3 BATTEN, ROUGH SAWN WOODGRAIN
SAP48BT	20	PEDIMENT COMBO SGMT ARCH W/BT SMOOTH	ST2P3T12X108CRS-G	43	SHUTTER 2 PLANK 3 BATTEN, ROUGH SAWN WOODGRAIN
SAP65	20	PEDIMENT COMBO SGMT ARCH SMOOTH	ST2P3T12X120CRS	39	SHUTTER 2 BOARD AND 3 BATTEN, ROUGH SAWN WOODGRAIN
SAP65BT	20	PEDIMENT COMBO SGMT ARCH W/BT SMOOTH	ST2P3T12X120CRS-G	43	SHUTTER 2 PLANK 3 BATTEN, ROUGH SAWN WOODGRAIN
SAP84	20	PEDIMENT COMBO SGMT ARCH SMOOTH	ST2P3T12X24CRS	39	SHUTTER 2 BOARD AND 3 BATTEN, ROUGH SAWN WOODGRAIN
SAP84BT	20	PEDIMENT COMBO SGMT ARCH W/BT SMOOTH	ST2P3T12X24CRS-G	43	SHUTTER 2 PLANK 3 BATTEN, ROUGH SAWN WOODGRAIN
SDG0.75X14X48S	179	WOODGRAIN SIDING	ST2P3T12X36CRS	39	SHUTTER 2 BOARD AND 3 BATTEN, ROUGH SAWN WOODGRAIN
SDG0.75X18.5X50S	179	WOODGRAIN SIDING	ST2P3T12X36CRS-G	43	SHUTTER 2 PLANK 3 BATTEN, ROUGH SAWN WOODGRAIN
SKPP6X108S	161	COLUMN, TIMBER TEXTURE	ST2P3T12X48CRS	39	SHUTTER 2 BOARD AND 3 BATTEN, ROUGH SAWN WOODGRAIN
SKPP6X120S	161	COLUMN, WOODGRAIN	ST2P3T12X48CRS-G	43	SHUTTER 2 PLANK 3 BATTEN, ROUGH SAWN WOODGRAIN
SKPP6X96S	161	COLUMN, WOODGRAIN	ST2P3T12X60CRS	39	SHUTTER 2 BOARD AND 3 BATTEN, ROUGH SAWN WOODGRAIN
SP56	19	PEDIMENT SUNBURST SMOOTH	ST2P3T12X60CRS-G	43	SHUTTER 2 PLANK 3 BATTEN, ROUGH SAWN WOODGRAIN
SP667	19	PEDIMENT SUNBURST SMOOTH	ST2P3T12X72CRS	39	SHUTTER 2 BOARD AND 3 BATTEN, ROUGH SAWN WOODGRAIN
SP86	19	PEDIMENT SUNBURST SMOOTH	ST2P3T12X72CRS-G	43	SHUTTER 2 PLANK 3 BATTEN, ROUGH SAWN WOODGRAIN
SP91	19	PEDIMENT SUNBURST SMOOTH	ST2P3T12X84CRS	39	SHUTTER 2 BOARD AND 3 BATTEN, ROUGH SAWN WOODGRAIN
SPCOL11X108	161	COLUMN SQUARE PLAIN SMOOTH	ST2P3T12X84CRS-G	43	SHUTTER 2 PLANK 3 BATTEN, ROUGH SAWN WOODGRAIN
SPCOL11X96	161	COLUMN SQUARE PLAIN SMOOTH	ST2P3T12X96CRS	39	SHUTTER 2 BOARD AND 3 BATTEN, ROUGH SAWN WOODGRAIN
SPCOL8X96	161	COLUMN SQUARE PLAIN SMOOTH	ST2P3T12X96CRS-G	43	SHUTTER 2 PLANK 3 BATTEN, ROUGH SAWN WOODGRAIN
ST2EP2T W X H1 X H2 CRS	56	ELLIPTICAL SHUTTERS-BOARD & BATTEN,WOODGRAIN	ST2PZT12X108CRS	47	SHUTTER 2 BOARD AND Z-BATTEN, ROUGH SAWN WOODGRAIN
ST2EP2T W X H1 X H2 CRS-G	55	ELLIPTICAL SHUTTERS — PLANK,WOODGRAIN	ST2PZT12X108CRS-G	50	SHUTTER 2 PLANK Z-BATTEN, ROUGH SAWN WOODGRAIN
ST2P2ET12X108CRS	52	SHUTTER 2 BOARD AND END BATTEN, ROUGH SAWN WOODGRAIN	ST2PZT12X120CRS	47	SHUTTER 2 BOARD AND Z-BATTEN, ROUGH SAWN WOODGRAIN
ST2P2ET12X120CRS	52	SHUTTER 2 BOARD AND END BATTEN, ROUGH SAWN WOODGRAIN	ST2PZT12X120CRS-G	50	SHUTTER 2 PLANK Z-BATTEN, ROUGH SAWN WOODGRAIN
ST2P2ET12X24CRS	52	SHUTTER 2 BOARD AND END BATTEN, ROUGH SAWN WOODGRAIN	ST2PZT12X24CRS	47	SHUTTER 2 BOARD AND Z-BATTEN, ROUGH SAWN WOODGRAIN
ST2P2ET12X36CRS	52	SHUTTER 2 BOARD AND END BATTEN, ROUGH SAWN WOODGRAIN	ST2PZT12X24CRS-G	50	SHUTTER 2 PLANK Z-BATTEN, ROUGH SAWN WOODGRAIN
ST2P2ET12X48CRS	52	SHUTTER 2 BOARD AND END BATTEN, ROUGH SAWN WOODGRAIN	ST2PZT12X36CRS	47	SHUTTER 2 BOARD AND Z-BATTEN, ROUGH SAWN WOODGRAIN
ST2P2ET12X60CRS	52	SHUTTER 2 BOARD AND END BATTEN, ROUGH SAWN WOODGRAIN	ST2PZT12X36CRS-G	50	SHUTTER 2 PLANK Z-BATTEN, ROUGH SAWN WOODGRAIN
ST2P2ET12X72CRS	52	SHUTTER 2 BOARD AND END BATTEN, ROUGH SAWN WOODGRAIN	ST2PZT12X48CRS	47	SHUTTER 2 BOARD AND Z-BATTEN, ROUGH SAWN WOODGRAIN
ST2P2ET12X84CRS	52	SHUTTER 2 BOARD AND END BATTEN, ROUGH SAWN WOODGRAIN	ST2PZT12X48CRS-G	50	SHUTTER 2 PLANK Z-BATTEN, ROUGH SAWN WOODGRAIN
ST2P2ET12X96CRS	52	SHUTTER 2 BOARD AND END BATTEN, ROUGH SAWN WOODGRAIN	ST2PZT12X60CRS	47	SHUTTER 2 BOARD AND Z-BATTEN, ROUGH SAWN WOODGRAIN
ST2P2T12X108CRS	39	SHUTTER 2 BOARD AND BATTEN, ROUGH SAWN WOODGRAIN	ST2PZT12X60CRS-G	50	SHUTTER 2 PLANK Z-BATTEN, ROUGH SAWN WOODGRAIN
ST2P2T12X108CRS-D	46	SHUTTER 2 PLANK W/DIAMOND, ROUGH SAWN WOODGRAIN	ST2PZT12X72CRS	47	SHUTTER 2 BOARD AND Z-BATTEN, ROUGH SAWN
ST2P2T12X108CRS-G	43	SHUTTER 2 PLANK, ROUGH SAWN WOODGRAIN	ST2PZT12X72CRS-G	50	SHUTTER 2 PLANK Z-BATTEN, ROUGH SAWN WOODGRAIN
ST2P2T12X120CRS	39	SHUTTER 2 BOARD AND BATTEN, ROUGH SAWN WOODGRAIN	ST2PZT12X84CRS	47	SHUTTER 2 BOARD AND Z-BATTEN, ROUGH SAWN WOODGRAIN
ST2P2T12X120CRS-D	46	SHUTTER 2 PLANK W/DIAMOND, ROUGH SAWN WOODGRAIN	ST2PZT12X84CRS-G	50	SHUTTER 2 PLANK Z-BATTEN, ROUGH SAWN WOODGRAIN
ST2P2T12X120CRS-G	43	SHUTTER 2 PLANK, ROUGH SAWN WOODGRAIN	ST2PZT12X96CRS	47	SHUTTER 2 BOARD AND Z-BATTEN, ROUGH SAWN WOODGRAIN
ST2P2T12X24CRS	39	SHUTTER 2 BOARD AND BATTEN, ROUGH SAWN WOODGRAIN	ST2PZT12X96CRS-G	50	SHUTTER 2 PLANK Z-BATTEN, ROUGH SAWN WOODGRAIN
ST2P2T12X24CRS-D	46	SHUTTER 2 PLANK W/DIAMOND, ROUGH SAWN WOODGRAIN	ST2RP2T12X108CRS	51	SHUTTER 2 ARCH TOP BOARD AND BATTEN, ROUGH SAWN
ST2P2T12X24CRS-G	43	SHUTTER 2 PLANK, ROUGH SAWN WOODGRAIN	ST2RP2T12X120CRS	51	SHUTTER 2 ARCH TOP BOARD AND BATTEN, ROUGH SAWN
ST2P2T12X36CRS	39	SHUTTER 2 BOARD AND BATTEN, ROUGH SAWN WOODGRAIN	ST2RP2T12X24CRS	51	SHUTTER 2 ARCH TOP BOARD AND BATTEN, ROUGH SAWN
ST2P2T12X36CRS-D	46	SHUTTER 2 PLANK W/DIAMOND, ROUGH SAWN WOODGRAIN	ST2RP2T12X36CRS	51	SHUTTER 2 ARCH TOP BOARD AND BATTEN, ROUGH SAWN
ST2P2T12X36CRS-G	43	SHUTTER 2 PLANK, ROUGH SAWN WOODGRAIN	ST2RP2T12X48CRS	51	SHUTTER 2 ARCH TOP BOARD AND BATTEN, ROUGH SAWN
ST2P2T12X48CRS	39	SHUTTER 2 BOARD AND BATTEN, ROUGH SAWN WOODGRAIN	ST2RP2T12X60CRS	51	SHUTTER 2 ARCH TOP BOARD AND BATTEN, ROUGH SAWN
ST2P2T12X48CRS-D	46	SHUTTER 2 PLANK W/DIAMOND, ROUGH SAWN WOODGRAIN	ST2RP2T12X72CRS	51	SHUTTER 2 ARCH TOP BOARD AND BATTEN, ROUGH SAWN

INDEX

Part#	Page	Description	Part#	Page	Description
ST2RP2T12X84CRS	51	SHUTTER 2 ARCH TOP BOARD AND BATTEN, ROUGH SAWN	ST3P2T18X96CRS-D	46	SHUTTER 3 PLANK W/DIAMOND, ROUGH SAWN WOODGRAIN
ST2RP2T12X96CRS	51	SHUTTER 2 ARCH TOP BOARD AND BATTEN, ROUGH SAWN	ST3P2T18X96CRS-6	44	SHUTTER 3 PLANK, ROUGH SAWN WOODGRAIN
ST3EP2T W X HI X H2 CRS	56	ELLIPTICAL SHUTTERS-BOARD & BATTEN,WOODGRAIN	ST3P2TK14X60CRS	61	SHUTTER 3 BOARD 2 BATTEN, ROUGH SAWN WOODGRAIN
ST3EP2T W X HI X H2 CRS-G	55	ELLIPTICAL SHUTTERS — PLANK,WOODGRAIN	ST3P2TK14X60CS	61	SHUTTER 3 BOARD 2 BATTEN, ROUGH TAHOE WOODGRAIN
ST3P2ET14X108CRS	52	SHUTTER 3 BOARD END BATTEN, ROUGH SAWN WOODGRAIN	ST3P2TK14X60HS	61	SHUTTER 3 BOARD 2 BATTEN, HAND SAWN WOODGRAIN
ST3P2ET14X120CRS	52	SHUTTER 3 BOARD END BATTEN, ROUGH SAWN WOODGRAIN	ST3P2TK14X60SCRS	60	SHUTTER 3 BOARD 2 BATTEN, SANDING CEDAR ROUGH SAWN WOODGRAIN
ST3P2ET14X24CRS	52	SHUTTER 3 BOARD END BATTEN, ROUGH SAWN WOODGRAIN	ST3P3T14X108CRS	40	SHUTTER 3 BOARD 3 BATTEN, ROUGH SAWN WOODGRAIN
ST3P2ET14X36CRS	52	SHUTTER 3 BOARD END BATTEN, ROUGH SAWN WOODGRAIN	ST3P3T14X120CRS	40	SHUTTER 3 BOARD 3 BATTEN, ROUGH SAWN WOODGRAIN
ST3P2ET14X48CRS	52	SHUTTER 3 BOARD END BATTEN, ROUGH SAWN WOODGRAIN	ST3P3T14X24CRS	40	SHUTTER 3 BOARD 3 BATTEN, ROUGH SAWN WOODGRAIN
ST3P2ET14X60CRS	52	SHUTTER 3 BOARD END BATTEN, ROUGH SAWN WOODGRAIN	ST3P3T14X36CRS	40	SHUTTER 3 BOARD 3 BATTEN, ROUGH SAWN WOODGRAIN
ST3P2ET14X72CRS	52	SHUTTER 3 BOARD END BATTEN, ROUGH SAWN WOODGRAIN	ST3P3T14X48CRS	40	SHUTTER 3 BOARD 3 BATTEN, ROUGH SAWN WOODGRAIN
ST3P2ET14X84CRS	52	SHUTTER 3 BOARD END BATTEN, ROUGH SAWN WOODGRAIN	ST3P3T14X60CRS	40	SHUTTER 3 BOARD 3 BATTEN, ROUGH SAWN WOODGRAIN
ST3P2ET14X96CRS	52	SHUTTER 3 BOARD END BATTEN, ROUGH SAWN WOODGRAIN	ST3P3T14X72CRS	40	SHUTTER 3 BOARD 3 BATTEN, ROUGH SAWN WOODGRAIN
ST3P2ET18X108CRS	52	SHUTTER 3 BOARD END BATTEN, ROUGH SAWN WOODGRAIN	ST3P3T14X84CRS	40	SHUTTER 3 BOARD 3 BATTEN, ROUGH SAWN WOODGRAIN
ST3P2ET18X120CRS	52	SHUTTER 3 BOARD END BATTEN, ROUGH SAWN WOODGRAIN	ST3P3T14X96CRS	40	SHUTTER 3 BOARD 3 BATTEN, ROUGH SAWN WOODGRAIN
ST3P2ET18X24CRS	52	SHUTTER 3 BOARD END BATTEN, ROUGH SAWN WOODGRAIN	ST3P3T18X108CRS	40	SHUTTER 3 BOARD 3 BATTEN, ROUGH SAWN WOODGRAIN
ST3P2ET18X36CRS	52	SHUTTER 3 BOARD END BATTEN, ROUGH SAWN WOODGRAIN	ST3P3T18X108CRS-G	44	SHUTTER 3 PLANK 3 BATTEN, ROUGH SAWN WOODGRAIN
ST3P2ET18X48CRS	52	SHUTTER 3 BOARD END BATTEN, ROUGH SAWN WOODGRAIN	ST3P3T18X120CRS	40	SHUTTER 3 BOARD 3 BATTEN, ROUGH SAWN WOODGRAIN
ST3P2ET18X60CRS	52	SHUTTER 3 BOARD END BATTEN, ROUGH SAWN WOODGRAIN	ST3P3T18X120CRS-G	44	SHUTTER 3 PLANK 3 BATTEN, ROUGH SAWN WOODGRAIN
ST3P2ET18X72CRS	52	SHUTTER 3 BOARD END BATTEN, ROUGH SAWN WOODGRAIN	ST3P3T18X24CRS	40	SHUTTER 3 BOARD 3 BATTEN, ROUGH SAWN WOODGRAIN
ST3P2ET18X84CRS	52	SHUTTER 3 BOARD END BATTEN, ROUGH SAWN WOODGRAIN	ST3P3T18X24CRS-G	44	SHUTTER 3 PLANK 3 BATTEN, ROUGH SAWN WOODGRAIN
ST3P2ET18X96CRS	52	SHUTTER 3 BOARD END BATTEN, ROUGH SAWN WOODGRAIN	ST3P3T18X36CRS	40	SHUTTER 3 BOARD 3 BATTEN, ROUGH SAWN WOODGRAIN
ST3P2T14X108CRS	40	SHUTTER 3 BOARD 2 BATTEN, ROUGH SAWN WOODGRAIN	ST3P3T18X36CRS-G	44	SHUTTER 3 PLANK 3 BATTEN, ROUGH SAWN WOODGRAIN
ST3P2T14X120CRS	40	SHUTTER 3 BOARD 2 BATTEN, ROUGH SAWN WOODGRAIN	ST3P3T18X48CRS	40	SHUTTER 3 BOARD 3 BATTEN, ROUGH SAWN WOODGRAIN
ST3P2T14X24CRS	40	SHUTTER 3 BOARD 2 BATTEN, ROUGH SAWN WOODGRAIN	ST3P3T18X48CRS-G	44	SHUTTER 3 PLANK 3 BATTEN, ROUGH SAWN WOODGRAIN
ST3P2T14X36CRS	40	SHUTTER 3 BOARD 2 BATTEN, ROUGH SAWN WOODGRAIN	ST3P3T18X60CRS	40	SHUTTER 3 BOARD 3 BATTEN, ROUGH SAWN WOODGRAIN
ST3P2T14X48CRS	40	SHUTTER 3 BOARD 2 BATTEN, ROUGH SAWN WOODGRAIN	ST3P3T18X60CRS-G	44	SHUTTER 3 PLANK 3 BATTEN, ROUGH SAWN WOODGRAIN
ST3P2T14X60CRS	40	SHUTTER 3 BOARD 2 BATTEN, ROUGH SAWN WOODGRAIN	ST3P3T18X72CRS	40	SHUTTER 3 BOARD 3 BATTEN, ROUGH SAWN WOODGRAIN
ST3P2T14X72CRS	40	SHUTTER 3 BOARD 2 BATTEN, ROUGH SAWN WOODGRAIN	ST3P3T18X72CRS-G	44	SHUTTER 3 PLANK 3 BATTEN, ROUGH SAWN WOODGRAIN
ST3P2T14X84CRS	40	SHUTTER 3 BOARD 2 BATTEN, ROUGH SAWN WOODGRAIN	ST3P3T18X84CRS	40	SHUTTER 3 BOARD 3 BATTEN, ROUGH SAWN WOODGRAIN
ST3P2T14X96CRS	40	SHUTTER 3 BOARD 2 BATTEN, ROUGH SAWN WOODGRAIN	ST3P3T18X84CRS-G	44	SHUTTER 3 PLANK 3 BATTEN, ROUGH SAWN WOODGRAIN
ST3P2T18X108CRS	40	SHUTTER 3 BOARD AND BATTEN, ROUGH SAWN WOODGRAIN	ST3P3T18X96CRS	40	SHUTTER 3 BOARD 3 BATTEN, ROUGH SAWN WOODGRAIN
ST3P2T18X108CRS-D	46	SHUTTER 3 PLANK W/DIAMOND, ROUGH SAWN WOODGRAIN	ST3P3T18X96CRS-G	44	SHUTTER 3 PLANK 3 BATTEN, ROUGH SAWN WOODGRAIN
ST3P2T18X108CRS-G	44	SHUTTER 3 PLANK, ROUGH SAWN WOODGRAIN	ST3PB15X46CRS	53	PANEL SHUTTER WITH BORDER,CEDER WOODGRAIN
ST3P2T18X120CRS	40	SHUTTER 3 BOARD AND BATTEN, ROUGH SAWN WOODGRAIN	ST3PB16X53	36	AMERICRAFT PANEL FRAMED BOARD-N-BATTEN SHUTTERS
ST3P2T18X120CRS-D	46	SHUTTER 3 PLANK W/DIAMOND, ROUGH SAWN WOODGRAIN	ST3PB16X72	36	AMERICRAFT PANEL FRAMED BOARD-N-BATTEN SHUTTERS
ST3P2T18X120CRS-G	44	SHUTTER 3 PLANK, ROUGH SAWN WOODGRAIN	ST3PB18X40CRS	53	PANEL SHUTTER WITH BORDER,CEDER WOODGRAIN
ST3P2T18X24CRS	40	SHUTTER 3 BOARD AND BATTEN, ROUGH SAWN WOODGRAIN	ST3PB18X66CRS	53	PANEL SHUTTER WITH BORDER,CEDER WOODGRAIN
ST3P2T18X24CRS-D	46	SHUTTER 3 PLANK W/DIAMOND, ROUGH SAWN WOODGRAIN	ST3PB24X54CRS	53	PANEL SHUTTER WITH BORDER,CEDER WOODGRAIN
ST3P2T18X24CRS-G	44	SHUTTER 3 PLANK, ROUGH SAWN WOODGRAIN	ST3PZT14X108CRS	48	SHUTTER 3 BOARD Z-BATTEN, ROUGH SAWN WOODGRAIN
ST3P2T18X36CRS	40	SHUTTER 3 BOARD AND BATTEN, ROUGH SAWN WOODGRAIN	ST3PZT14X120CRS	48	SHUTTER 3 BOARD Z-BATTEN, ROUGH SAWN WOODGRAIN
ST3P2T18X36CRS-D	46	SHUTTER 3 PLANK W/DIAMOND, ROUGH SAWN WOODGRAIN	ST3PZT14X24CRS	48	SHUTTER 3 BOARD Z-BATTEN, ROUGH SAWN WOODGRAIN
ST3P2T18X36CRS-G	44	SHUTTER 3 PLANK, ROUGH SAWN WOODGRAIN	ST3PZT14X36CRS	48	SHUTTER 3 BOARD Z-BATTEN, ROUGH SAWN WOODGRAIN
ST3P2T18X48CRS	40	SHUTTER 3 BOARD AND BATTEN, ROUGH SAWN WOODGRAIN	ST3PZT14X48CRS	48	SHUTTER 3 BOARD Z-BATTEN, ROUGH SAWN WOODGRAIN
ST3P2T18X48CRS-D	46	SHUTTER 3 PLANK W/DIAMOND, ROUGH SAWN WOODGRAIN	ST3PZT14X60CRS	48	SHUTTER 3 BOARD Z-BATTEN, ROUGH SAWN WOODGRAIN
ST3P2T18X48CRS-G	44	SHUTTER 3 PLANK, ROUGH SAWN WOODGRAIN	ST3PZT14X72CRS	48	SHUTTER 3 BOARD Z-BATTEN, ROUGH SAWN WOODGRAIN
ST3P2T18X60CRS	40	SHUTTER 3 BOARD AND BATTEN, ROUGH SAWN WOODGRAIN	ST3PZT14X84CRS	48	SHUTTER 3 BOARD Z-BATTEN, ROUGH SAWN WOODGRAIN
ST3P2T18X60CRS-D	46	SHUTTER 3 PLANK W/DIAMOND, ROUGH SAWN WOODGRAIN	ST3PZT14X96CRS	48	SHUTTER 3 BOARD Z-BATTEN, ROUGH SAWN WOODGRAIN
ST3P2T18X60CRS-G	44	SHUTTER 3 PLANK, ROUGH SAWN WOODGRAIN	ST3PZT18X108CRS	48	SHUTTER 3 BOARD Z-BATTEN, ROUGH SAWN WOODGRAIN
ST3P2T18X72CRS	40	SHUTTER 3 BOARD AND BATTEN, ROUGH SAWN WOODGRAIN	ST3PZT18X108CRS-G	50	SHUTTER 3 PLANK Z-BATTEN, ROUGH SAWN WOODGRAIN
ST3P2T18X72CRS-D	46	SHUTTER 3 PLANK W/DIAMOND, ROUGH SAWN WOODGRAIN	ST3PZT18X120CRS	48	SHUTTER 3 BOARD Z-BATTEN, ROUGH SAWN WOODGRAIN
ST3P2T18X72CRS-G	44	SHUTTER 3 PLANK, ROUGH SAWN WOODGRAIN	ST3PZT18X120CRS-G	50	SHUTTER 3 PLANK Z-BATTEN, ROUGH SAWN WOODGRAIN
ST3P2T18X84CRS	40	SHUTTER 3 BOARD AND BATTEN, ROUGH SAWN WOODGRAIN	ST3PZT18X24CRS	48	SHUTTER 3 BOARD Z-BATTEN, ROUGH SAWN WOODGRAIN
ST3P2T18X84CRS-D	46	SHUTTER 3 PLANK W/DIAMOND, ROUGH SAWN WOODGRAIN	ST3PZT18X24CRS-G	50	SHUTTER 3 PLANK Z-BATTEN, ROUGH SAWN WOODGRAIN
ST3P2T18X84CRS-G	44	SHUTTER 3 PLANK, ROUGH SAWN WOODGRAIN	ST3PZT18X36CRS	48	SHUTTER 3 BOARD Z-BATTEN, ROUGH SAWN WOODGRAIN
ST3P2T18X96CRS	40	SHUTTER 3 BOARD AND BATTEN, ROUGH SAWN WOODGRAIN	ST3PZT18X36CRS-G	50	SHUTTER 3 PLANK Z-BATTEN, ROUGH SAWN WOODGRAIN

INDEX

Part#	Page	Description	Part#	Page	Description
STCSPYR1.25	57	PYRAMID CLAVOS	TLV60X18	89	TRIANGLE LOUVER DECO SMOOTH
STCSRND1.25	57	ROUND CLAVOS	TLV60X18F	89	LOUVER FUNC TRIANGLE SMOOTH
STDP16X48	35	SHUTTER RAISED PANEL DOUBLE SMOOTH	TLV60X18FS	98	TRIANGLE LOUVER FUNC,WOODGRAIN
STDP16X54	35	SHUTTER RAISED PANEL DOUBLE SMOOTH	TLV60X18S	98	TRIANGLE LOUVER DECO,WOODGRAIN
STDP16X60	35	SHUTTER RAISED PANEL DOUBLE SMOOTH	TLV60X23	89	TRIANGLE LOUVER DECO SMOOTH
STDP16X65	35	SHUTTER RAISED PANEL DOUBLE SMOOTH	TLV60X23F	89	LOUVER FUNC TRIANGLE SMOOTH
STDP16X72	35	SHUTTER RAISED PANEL DOUBLE SMOOTH	TLV60X23FS	98	TRIANGLE LOUVER FUNC,WOODGRAIN
STDP18X53	35	SHUTTER RAISED PANEL DOUBLE SMOOTH	TLV60X23S	98	TRIANGLE LOUVER DECO,WOODGRAIN
STDP18X59	35	SHUTTER RAISED PANEL DOUBLE SMOOTH	TLV60X25	89	TRIANGLE LOUVER DECO SMOOTH
STDP18X66	35	SHUTTER RAISED PANEL DOUBLE SMOOTH	TLV60X25F	89	LOUVER FUNC TRIANGLE SMOOTH
STDP18X72	35	SHUTTER RAISED PANEL DOUBLE SMOOTH	TLV60X25FS	98	TRIANGLE LOUVER FUNC,WOODGRAIN
STDPK16X60KS	60	WOODGRAIN THICK PANEL SHUTTER-OAK	TLV60X25S	98	TRIANGLE LOUVER DECO,WOODGRAIN
STFP12X144	58	SHAKER SHUTTER BOARDS 12X144 SMOOTH	TLV60X30	89	TRIANGLE LOUVER DECO SMOOTH
STFP16X144	58	SHAKER SHUTTER BOARDS 16X144 SMOOTH	TLV60X30F	89	LOUVER FUNC TRIANGLE SMOOTH
STFP18X144	58	SHAKER SHUTTER BOARDS 18X144 SMOOTH	TLV60X30FS	98	TRIANGLE LOUVER FUNC,WOODGRAIN
STFP24X144	58	SHAKER SHUTTER BOARDS 24X144 SMOOTH	TLV60X30S	98	TRIANGLE LOUVER DECO,WOODGRAIN
STHGCOL10	57	COLONIAL HINGES	TLV64X27	89	TRIANGLE LOUVER DECO SMOOTH
STHGCOL16	57	COLONIAL HINGES	TLV64X27F	89	LOUVER FUNC TRIANGLE SMOOTH
STHGSPR10	57	SPEAR HINGES	TLV64X27FS	98	TRIANGLE LOUVER FUNC,WOODGRAIN
STHGSPR16	57	SPEAR HINGES	TLV64X27S	98	TRIANGLE LOUVER DECO,WOODGRAIN
T6C	158	NEWEL POST TRIM COLLAR SMOOTH	TLV64X32	89	TRIANGLE LOUVER DECO SMOOTH
T8-8C	158	NEWEL POST TRIM COLLAR SMOOTH	TLV64X32F	89	LOUVER FUNC TRIANGLE SMOOTH
T8C	158	NEWEL POST TRIM COLLAR SMOOTH	TLV64X32FS	98	TRIANGLE LOUVER FUNC,WOODGRAIN
TL1X25X96	178	TILE	TLV64X32S	98	TRIANGLE LOUVER DECO,WOODGRAIN
TLV32X16	89	TRIANGLE LOUVER DECO SMOOTH	TLV66X22	89	TRIANGLE LOUVER DECO SMOOTH
TLV32X16F	89	LOUVER FUNC TRIANGLE SMOOTH	TLV66X22F	89	LOUVER FUNC TRIANGLE SMOOTH
TLV32X16FS	98	TRIANGLE LOUVER FUNC,WOODGRAIN	TLV72X36	89	TRIANGLE LOUVER DECO SMOOTH
TLV32X16S	98	TRIANGLE LOUVER DECO,WOODGRAIN	TLV72X36F	89	LOUVER FUNC TRIANGLE SMOOTH
TLV36X18	89	TRIANGLE LOUVER DECO SMOOTH	TLV76X19	89	TRIANGLE LOUVER DECO SMOOTH
TLV36X18F	89	LOUVER FUNC TRIANGLE SMOOTH	TLV76X19F	89	LOUVER FUNC TRIANGLE SMOOTH
TLV36X18FS	98	TRIANGLE LOUVER FUNC,WOODGRAIN	TLV84X18	89	TRIANGLE LOUVER DECO SMOOTH
TLV36X18S	98	TRIANGLE LOUVER DECO,WOODGRAIN	TLV84X18F	89	LOUVER FUNC TRIANGLE SMOOTH
TLV42X21	89	TRIANGLE LOUVER DECO SMOOTH	TLV84X21	89	TRIANGLE LOUVER DECO SMOOTH
TLV42X21F	89	LOUVER FUNC TRIANGLE SMOOTH	TLV84X21F	89	LOUVER FUNC TRIANGLE SMOOTH
TLV42X21FS	98	TRIANGLE LOUVER FUNC,WOODGRAIN	TLV88X22	89	TRIANGLE LOUVER DECO SMOOTH
TLV42X21S	98	TRIANGLE LOUVER DECO,WOODGRAIN	TLV88X22F	89	LOUVER FUNC TRIANGLE SMOOTH
TLV48X12	89	TRIANGLE LOUVER DECO SMOOTH	TLVLR108X27	90	2PC TRIANGLE LOUVER DECO SMOOTH
TLV48X12F	89	LOUVER FUNC TRIANGLE SMOOTH	TLVLR108X27F	90	LOUVER FUNC 2PC TRIANGLE SMOOTH
TLV48X12FS	98	TRIANGLE LOUVER FUNC,WOODGRAIN	TLVLR115X35	90	2PC TRIANGLE LOUVER DECO SMOOTH
TLV48X12S	98	TRIANGLE LOUVER DECO,WOODGRAIN	TLVLR115X35F	90	LOUVER FUNC 2PC TRIANGLE SMOOTH
TLV48X16	89	TRIANGLE LOUVER DECO SMOOTH	TLVLR120X30	90	2PC TRIANGLE LOUVER DECO SMOOTH
TLV48X16F	89	LOUVER FUNC TRIANGLE SMOOTH	TLVLR120X30F	90	LOUVER FUNC 2PC TRIANGLE SMOOTH
TLV48X16FS	98	TRIANGLE LOUVER FUNC,WOODGRAIN	TLVLR60X25	90	2PC TRIANGLE LOUVER DECO SMOOTH
TLV48X16S	98	TRIANGLE LOUVER DECO,WOODGRAIN	TLVLR60X25F	90	LOUVER FUNC 2PC TRIANGLE SMOOTH
TLV48X18	89	TRIANGLE LOUVER DECO SMOOTH	TLVLR60X30	90	2PC TRIANGLE LOUVER DECO SMOOTH
TLV48X18F	89	LOUVER FUNC TRIANGLE SMOOTH	TLVLR60X30F	90	LOUVER FUNC 2PC TRIANGLE SMOOTH
TLV48X18FS	98	TRIANGLE LOUVER FUNC,WOODGRAIN	TR5X144	153	BALUSTER STRAIGHT TOP RAIL SMOOTH
TLV48X18S	98	TRIANGLE LOUVER DECO,WOODGRAIN	TR5X96	153	BALUSTER STRAIGHT TOP RAIL SMOOTH
TLV48X22	89	TRIANGLE LOUVER DECO SMOOTH	TR7X120	155	BALUSTER STRAIGHT TOP RAIL SMOOTH
TLV48X22F	89	LOUVER FUNC TRIANGLE SMOOTH	TR7X144	155	BALUSTER STRAIGHT TOP RAIL SMOOTH
TLV48X22FS	98	TRIANGLE LOUVER FUNC,WOODGRAIN	TR7X96	155	BALUSTER STRAIGHT TOP RAIL SMOOTH
TLV48X22S	98	TRIANGLE LOUVER DECO,WOODGRAIN	WDP36X18	31	WINDOW PANEL RAISED SMOOTH
TLV48X24	89	TRIANGLE LOUVER DECO SMOOTH	WH100X10BT	9	CROSSHEAD W/BT SMOOTH
TLV48X24F	89	LOUVER FUNC TRIANGLE SMOOTH	WH100X6	8	CROSSHEAD SMOOTH
TLV48X24FS	98	TRIANGLE LOUVER FUNC,WOODGRAIN	WH100X6D	8	CROSSHEAD W/DT SMOOTH
TLV48X24S	98	TRIANGLE LOUVER DECO,WOODGRAIN	WH100X6K	8	CROSSHEAD W/KEY SMOOTH

INDEX

Part#	Page	Description	Part#	Page	Description
WH100X6T	8	CROSSHEAD W/TS SMOOTH	WH110X7BT	8	CROSSHEAD W/BT SMOOTH
WH100X7BT	8	CROSSHEAD W/BT SMOOTH	WH110X9	9	CROSSHEAD SMOOTH
WH100X9	9	CROSSHEAD SMOOTH	WH110X9D	9	CROSSHEAD W/DT SMOOTH
WH100X9D	9	CROSSHEAD W/DT SMOOTH	WH110X9K	9	CROSSHEAD W/KEY SMOOTH
WH100X9K	9	CROSSHEAD W/KEY SMOOTH	WH110X9T	9	CROSSHEAD W/TS SMOOTH
WH100X9T	9	CROSSHEAD W/TS SMOOTH	WH112X10BT	9	CROSSHEAD W/BT SMOOTH
WH101X10BT	9	CROSSHEAD W/BT SMOOTH	WH112X9	9	CROSSHEAD SMOOTH
WH101X9	9	CROSSHEAD SMOOTH	WH112X9D	9	CROSSHEAD W/DT SMOOTH
WH101X9D	9	CROSSHEAD W/DT SMOOTH	WH112X9K	9	CROSSHEAD W/KEY SMOOTH
WH101X9K	9	CROSSHEAD W/KEY SMOOTH	WH112X9T	9	CROSSHEAD W/TS SMOOTH
WH101X9T	9	CROSSHEAD W/TS SMOOTH	WH113X10BT	9	CROSSHEAD W/BT SMOOTH
WH102X12	10	CROSSHEAD SMOOTH	WH113X9	9	CROSSHEAD SMOOTH
WH102X12D	10	CROSSHEAD W/DT SMOOTH	WH113X9D	9	CROSSHEAD W/DT SMOOTH
WH102X12K	10	CROSSHEAD W/KEY SMOOTH	WH113X9K	9	CROSSHEAD W/KEY SMOOTH
WH102X12T	10	CROSSHEAD W/TS SMOOTH	WH113X9T	9	CROSSHEAD W/TS SMOOTH
WH102X13BT	10	CROSSHEAD W/BT SMOOTH	WH120X10BT	9	CROSSHEAD W/BT SMOOTH
WH103X10BT	9	CROSSHEAD W/BT SMOOTH	WH120X9	9	CROSSHEAD SMOOTH
WH103X6	8	CROSSHEAD SMOOTH	WH120X9D	9	CROSSHEAD W/DT SMOOTH
WH103X6D	8	CROSSHEAD W/DT SMOOTH	WH120X9K	9	CROSSHEAD W/KEY SMOOTH
WH103X6K	8	CROSSHEAD W/KEY SMOOTH	WH120X9T	9	CROSSHEAD W/TS SMOOTH
WH103X6T	8	CROSSHEAD W/TS SMOOTH	WH124X10BT	9	CROSSHEAD W/BT SMOOTH
WH103X7BT	8	CROSSHEAD W/BT SMOOTH	WH124X9	9	CROSSHEAD SMOOTH
WH103X9	9	CROSSHEAD SMOOTH	WH124X9D	9	CROSSHEAD W/DT SMOOTH
WH103X9D	9	CROSSHEAD W/DT SMOOTH	WH124X9K	9	CROSSHEAD W/KEY SMOOTH
WH103X9K	9	CROSSHEAD W/KEY SMOOTH	WH124X9T	9	CROSSHEAD W/TS SMOOTH
WH103X9T	9	CROSSHEAD W/TS SMOOTH	WH144X10BT	9	CROSSHEAD W/BT SMOOTH
WH104X10BT	9	CROSSHEAD W/BT SMOOTH	WH144X12	10	CROSSHEAD SMOOTH
WH104X12	10	CROSSHEAD SMOOTH	WH144X12D	10	CROSSHEAD W/DT SMOOTH
WH104X12D	10	CROSSHEAD W/DT SMOOTH	WH144X12K	10	CROSSHEAD W/KEY SMOOTH
WH104X12K	10	CROSSHEAD W/KEY SMOOTH	WH144X12T	10	CROSSHEAD W/TS SMOOTH
WH104X12T	10	CROSSHEAD W/TS SMOOTH	WH144X13BT	10	CROSSHEAD W/BT SMOOTH
WH104X13BT	10	CROSSHEAD W/BT SMOOTH	WH144X6	8	CROSSHEAD SMOOTH
WH104X6	8	CROSSHEAD SMOOTH	WH144X6D	8	CROSSHEAD W/DT SMOOTH
WH104X6D	8	CROSSHEAD W/DT SMOOTH	WH144X6K	8	CROSSHEAD W/KEY SMOOTH
WH104X6K	8	CROSSHEAD W/KEY SMOOTH	WH144X6T	8	CROSSHEAD W/TS SMOOTH
WH104X6T	8	CROSSHEAD W/TS SMOOTH	WH144X7BT	8	CROSSHEAD W/BT SMOOTH
WH104X7BT	8	CROSSHEAD W/BT SMOOTH	WH144X9	9	CROSSHEAD SMOOTH
WH104X9	9	CROSSHEAD SMOOTH	WH144X9D	9	CROSSHEAD W/DT SMOOTH
WH104X9D	9	CROSSHEAD W/DT SMOOTH	WH144X9K	9	CROSSHEAD W/KEY SMOOTH
WH104X9K	9	CROSSHEAD W/KEY SMOOTH	WH144X9T	9	CROSSHEAD W/TS SMOOTH
WH104X9T	9	CROSSHEAD W/TS SMOOTH	WH192X10BT	9	CROSSHEAD W/BT SMOOTH
WH108X10BT	9	CROSSHEAD W/BT SMOOTH	WH192X9	9	CROSSHEAD SMOOTH
WH108X6	8	CROSSHEAD SMOOTH	WH192X9D	9	CROSSHEAD W/DT SMOOTH
WH108X6D	8	CROSSHEAD W/DT SMOOTH	WH192X9K	9	CROSSHEAD W/KEY SMOOTH
WH108X6K	8	CROSSHEAD W/KEY SMOOTH	WH192X9T	9	CROSSHEAD W/TS SMOOTH
WH108X6T	8	CROSSHEAD W/TS SMOOTH	WH196X10BT	9	CROSSHEAD W/BT SMOOTH
WH108X7BT	8	CROSSHEAD W/BT SMOOTH	WH196X9	9	CROSSHEAD SMOOTH
WH108X9	9	CROSSHEAD SMOOTH	WH196X9D	9	CROSSHEAD W/DT SMOOTH
WH108X9D	9	CROSSHEAD W/DT SMOOTH	WH196X9K	9	CROSSHEAD W/KEY SMOOTH
WH108X9K	9	CROSSHEAD W/KEY SMOOTH	WH196X9T	9	CROSSHEAD W/TS SMOOTH
WH108X9T	9	CROSSHEAD W/TS SMOOTH	WH197X10BT	9	CROSSHEAD W/BT SMOOTH
WH110X10BT	9	CROSSHEAD W/BT SMOOTH	WH197X9	9	CROSSHEAD SMOOTH
WH110X6	8	CROSSHEAD SMOOTH	WH197X9D	9	CROSSHEAD W/DT SMOOTH
WH110X6D	8	CROSSHEAD W/DT SMOOTH	WH197X9K	9	CROSSHEAD W/KEY SMOOTH
WH110X6K	8	CROSSHEAD W/KEY SMOOTH	WH197X9T	9	CROSSHEAD W/TS SMOOTH
WH110X6T	8	CROSSHEAD W/TS SMOOTH	WH200X10BT	9	CROSSHEAD W/BT SMOOTH

INDEX

Part#	Page	Description	Part#	Page	Description
WH200X12	10	CROSSHEAD SMOOTH	WH27X9D	9	CROSSHEAD W/DT SMOOTH
WH200X12D	10	CROSSHEAD W/DT SMOOTH	WH27X9K	9	CROSSHEAD W/KEY SMOOTH
WH200X12K	10	CROSSHEAD W/KEY SMOOTH	WH27X9T	9	CROSSHEAD W/TS SMOOTH
WH200X12T	10	CROSSHEAD W/TS SMOOTH	WH28X10BT	9	CROSSHEAD W/BT SMOOTH
WH200X13BT	10	CROSSHEAD W/BT SMOOTH	WH28X6	8	CROSSHEAD SMOOTH
WH200X9	9	CROSSHEAD SMOOTH	WH28X6D	8	CROSSHEAD W/DT SMOOTH
WH200X9D	9	CROSSHEAD W/DT SMOOTH	WH28X6K	8	CROSSHEAD W/KEY SMOOTH
WH200X9K	9	CROSSHEAD W/KEY SMOOTH	WH28X6T	8	CROSSHEAD W/TS SMOOTH
WH200X9T	9	CROSSHEAD W/TS SMOOTH	WH28X7BT	8	CROSSHEAD W/BT SMOOTH
WH203X12	10	CROSSHEAD SMOOTH	WH28X9	9	CROSSHEAD SMOOTH
WH203X12D	10	CROSSHEAD W/DT SMOOTH	WH28X9D	9	CROSSHEAD W/DT SMOOTH
WH203X12K	10	CROSSHEAD W/KEY SMOOTH	WH28X9K	9	CROSSHEAD W/KEY SMOOTH
WH203X12T	10	CROSSHEAD W/TS SMOOTH	WH28X9T	9	CROSSHEAD W/TS SMOOTH
WH203X13BT	10	CROSSHEAD W/BT SMOOTH	WH29X10BT	9	CROSSHEAD W/BT SMOOTH
WH204X10BT	9	CROSSHEAD W/BT SMOOTH	WH29X9	9	CROSSHEAD SMOOTH
WH204X9	9	CROSSHEAD SMOOTH	WH29X9D	9	CROSSHEAD W/DT SMOOTH
WH204X9D	9	CROSSHEAD W/DT SMOOTH	WH29X9K	9	CROSSHEAD W/KEY SMOOTH
WH204X9K	9	CROSSHEAD W/KEY SMOOTH	WH29X9T	9	CROSSHEAD W/TS SMOOTH
WH204X9T	9	CROSSHEAD W/TS SMOOTH	WH30X10BT	9	CROSSHEAD W/BT SMOOTH
WH207X10BT	9	CROSSHEAD W/BT SMOOTH	WH30X6	8	CROSSHEAD SMOOTH
WH207X9	9	CROSSHEAD SMOOTH	WH30X6D	8	CROSSHEAD W/DT SMOOTH
WH207X9D	9	CROSSHEAD W/DT SMOOTH	WH30X6K	8	CROSSHEAD W/KEY SMOOTH
WH207X9K	9	CROSSHEAD W/KEY SMOOTH	WH30X6T	8	CROSSHEAD W/TS SMOOTH
WH207X9T	9	CROSSHEAD W/TS SMOOTH	WH30X7BT	8	CROSSHEAD W/BT SMOOTH
WH20X10BT	9	CROSSHEAD W/BT SMOOTH	WH30X9	9	CROSSHEAD SMOOTH
WH20X9	9	CROSSHEAD SMOOTH	WH30X9D	9	CROSSHEAD W/DT SMOOTH
WH20X9D	9	CROSSHEAD W/DT SMOOTH	WH30X9K	9	CROSSHEAD W/KEY SMOOTH
WH20X9K	9	CROSSHEAD W/KEY SMOOTH	WH30X9T	9	CROSSHEAD W/TS SMOOTH
WH20X9T	9	CROSSHEAD W/TS SMOOTH	WH31X6	8	CROSSHEAD SMOOTH
WH213X12	10	CROSSHEAD SMOOTH	WH31X6D	8	CROSSHEAD W/DT SMOOTH
WH213X12D	10	CROSSHEAD W/DT SMOOTH	WH31X6K	8	CROSSHEAD W/KEY SMOOTH
WH213X12K	10	CROSSHEAD W/KEY SMOOTH	WH31X6T	8	CROSSHEAD W/TS SMOOTH
WH213X12T	10	CROSSHEAD W/TS SMOOTH	WH31X7BT	8	CROSSHEAD W/BT SMOOTH
WH213X13BT	10	CROSSHEAD W/BT SMOOTH	WH32X10BT	9	CROSSHEAD W/BT SMOOTH
WH24X10BT	9	CROSSHEAD W/BT SMOOTH	WH32X6	8	CROSSHEAD SMOOTH
WH24X6	8	CROSSHEAD SMOOTH	WH32X6D	8	CROSSHEAD W/DT SMOOTH
WH24X6D	8	CROSSHEAD W/DT SMOOTH	WH32X6K	8	CROSSHEAD W/KEY SMOOTH
WH24X6K	8	CROSSHEAD W/KEY SMOOTH	WH32X6T	8	CROSSHEAD W/TS SMOOTH
WH24X6T	8	CROSSHEAD W/TS SMOOTH	WH32X7BT	8	CROSSHEAD W/BT SMOOTH
WH24X7BT	8	CROSSHEAD W/BT SMOOTH	WH32X9	9	CROSSHEAD SMOOTH
WH24X9	9	CROSSHEAD SMOOTH	WH32X9D	9	CROSSHEAD W/DT SMOOTH
WH24X9D	9	CROSSHEAD W/DT SMOOTH	WH32X9K	9	CROSSHEAD W/KEY SMOOTH
WH24X9K	9	CROSSHEAD W/KEY SMOOTH	WH32X9T	9	CROSSHEAD W/TS SMOOTH
WH24X9T	9	CROSSHEAD W/TS SMOOTH	WH33X10BT	9	CROSSHEAD W/BT SMOOTH
WH25X10BT	9	CROSSHEAD W/BT SMOOTH	WH33X6	8	CROSSHEAD SMOOTH
WH25X9	9	CROSSHEAD SMOOTH	WH33X6D	8	CROSSHEAD W/DT SMOOTH
WH25X9D	9	CROSSHEAD W/DT SMOOTH	WH33X6K	8	CROSSHEAD W/KEY SMOOTH
WH25X9K	9	CROSSHEAD W/KEY SMOOTH	WH33X6T	8	CROSSHEAD W/TS SMOOTH
WH25X9T	9	CROSSHEAD W/TS SMOOTH	WH33X7BT	8	CROSSHEAD W/BT SMOOTH
WH26X10BT	9	CROSSHEAD W/BT SMOOTH	WH33X9	9	CROSSHEAD SMOOTH
WH26X9	9	CROSSHEAD SMOOTH	WH33X9D	9	CROSSHEAD W/DT SMOOTH
WH26X9D	9	CROSSHEAD W/DT SMOOTH	WH33X9K	9	CROSSHEAD W/KEY SMOOTH
WH26X9K	9	CROSSHEAD W/KEY SMOOTH	WH33X9T	9	CROSSHEAD W/TS SMOOTH
WH26X9T	9	CROSSHEAD W/TS SMOOTH	WH34X10BT	9	CROSSHEAD W/BT SMOOTH
WH27X10BT	9	CROSSHEAD W/BT SMOOTH	WH34X6	8	CROSSHEAD SMOOTH
WH27X9	9	CROSSHEAD SMOOTH	WH34X6D	8	CROSSHEAD W/DT SMOOTH

INDEX

Part#	Page	Description	Part#	Page	Description
WH34X6K	8	CROSSHEAD W/KEY SMOOTH	WH40X12T	10	CROSSHEAD W/TS SMOOTH
WH34X6T	8	CROSSHEAD W/TS SMOOTH	WH40X13BT	10	CROSSHEAD W/BT SMOOTH
WH34X7BT	8	CROSSHEAD W/BT SMOOTH	WH40X6	8	CROSSHEAD SMOOTH
WH34X9	9	CROSSHEAD SMOOTH	WH40X6D	8	CROSSHEAD W/DT SMOOTH
WH34X9D	9	CROSSHEAD W/DT SMOOTH	WH40X6K	8	CROSSHEAD W/KEY SMOOTH
WH34X9K	9	CROSSHEAD W/KEY SMOOTH	WH40X6T	8	CROSSHEAD W/TS SMOOTH
WH34X9T	9	CROSSHEAD W/TS SMOOTH	WH40X7BT	8	CROSSHEAD W/BT SMOOTH
WH35X10BT	9	CROSSHEAD W/BT SMOOTH	WH40X9	9	CROSSHEAD SMOOTH
WH35X6	8	CROSSHEAD SMOOTH	WH40X9D	9	CROSSHEAD W/DT SMOOTH
WH35X6D	8	CROSSHEAD W/DT SMOOTH	WH40X9K	9	CROSSHEAD W/KEY SMOOTH
WH35X6K	8	CROSSHEAD W/KEY SMOOTH	WH40X9T	9	CROSSHEAD W/TS SMOOTH
WH35X6T	8	CROSSHEAD W/TS SMOOTH	WH41X10BT	9	CROSSHEAD W/BT SMOOTH
WH35X7BT	8	CROSSHEAD W/BT SMOOTH	WH41X6	8	CROSSHEAD SMOOTH
WH35X9	9	CROSSHEAD SMOOTH	WH41X6D	8	CROSSHEAD W/DT SMOOTH
WH35X9D	9	CROSSHEAD W/DT SMOOTH	WH41X6K	8	CROSSHEAD W/KEY SMOOTH
WH35X9K	9	CROSSHEAD W/KEY SMOOTH	WH41X6T	8	CROSSHEAD W/TS SMOOTH
WH35X9T	9	CROSSHEAD W/TS SMOOTH	WH41X7BT	8	CROSSHEAD W/BT SMOOTH
WH36X10BT	9	CROSSHEAD W/BT SMOOTH	WH41X9	9	CROSSHEAD SMOOTH
WH36X12	10	CROSSHEAD SMOOTH	WH41X9D	9	CROSSHEAD W/DT SMOOTH
WH36X12D	10	CROSSHEAD W/DT SMOOTH	WH41X9K	9	CROSSHEAD W/KEY SMOOTH
WH36X12K	10	CROSSHEAD W/KEY SMOOTH	WH41X9T	9	CROSSHEAD W/TS SMOOTH
WH36X12T	10	CROSSHEAD W/TS SMOOTH	WH42X10BT	9	CROSSHEAD W/BT SMOOTH
WH36X13BT	10	CROSSHEAD W/BT SMOOTH	WH42X9	9	CROSSHEAD SMOOTH
WH36X6	8	CROSSHEAD SMOOTH	WH42X9D	9	CROSSHEAD W/DT SMOOTH
WH36X6D	8	CROSSHEAD W/DT SMOOTH	WH42X9K	9	CROSSHEAD W/KEY SMOOTH
WH36X6K	8	CROSSHEAD W/KEY SMOOTH	WH42X9T	9	CROSSHEAD W/TS SMOOTH
WH36X6T	8	CROSSHEAD W/TS SMOOTH	WH43X10BT	9	CROSSHEAD W/BT SMOOTH
WH36X7BT	8	CROSSHEAD W/BT SMOOTH	WH43X6	8	CROSSHEAD SMOOTH
WH36X9	9	CROSSHEAD SMOOTH	WH43X6D	8	CROSSHEAD W/DT SMOOTH
WH36X9D	9	CROSSHEAD W/DT SMOOTH	WH43X6K	8	CROSSHEAD W/KEY SMOOTH
WH36X9K	9	CROSSHEAD W/KEY SMOOTH	WH43X6T	8	CROSSHEAD W/TS SMOOTH
WH36X9T	9	CROSSHEAD W/TS SMOOTH	WH43X7BT	8	CROSSHEAD W/BT SMOOTH
WH37X10BT	9	CROSSHEAD W/BT SMOOTH	WH43X9	9	CROSSHEAD SMOOTH
WH37X6	8	CROSSHEAD SMOOTH	WH43X9D	9	CROSSHEAD W/DT SMOOTH
WH37X6D	8	CROSSHEAD W/DT SMOOTH	WH43X9K	9	CROSSHEAD W/KEY SMOOTH
WH37X6K	8	CROSSHEAD W/KEY SMOOTH	WH43X9T	9	CROSSHEAD W/TS SMOOTH
WH37X6T	8	CROSSHEAD W/TS SMOOTH	WH44X10BT	9	CROSSHEAD W/BT SMOOTH
WH37X7BT	8	CROSSHEAD W/BT SMOOTH	WH44X12	10	CROSSHEAD SMOOTH
WH37X9	9	CROSSHEAD SMOOTH	WH44X12D	10	CROSSHEAD W/DT SMOOTH
WH37X9D	9	CROSSHEAD W/DT SMOOTH	WH44X12K	10	CROSSHEAD W/KEY SMOOTH
WH37X9K	9	CROSSHEAD W/KEY SMOOTH	WH44X12T	10	CROSSHEAD W/TS SMOOTH
WH37X9T	9	CROSSHEAD W/TS SMOOTH	WH44X13BT	10	CROSSHEAD W/BT SMOOTH
WH38X10BT	9	CROSSHEAD W/BT SMOOTH	WH44X6	8	CROSSHEAD SMOOTH
WH38X6	8	CROSSHEAD SMOOTH	WH44X6D	8	CROSSHEAD W/DT SMOOTH
WH38X6D	8	CROSSHEAD W/DT SMOOTH	WH44X6K	8	CROSSHEAD W/KEY SMOOTH
WH38X6K	8	CROSSHEAD W/KEY SMOOTH	WH44X6T	8	CROSSHEAD W/TS SMOOTH
WH38X6T	8	CROSSHEAD W/TS SMOOTH	WH44X7BT	8	CROSSHEAD W/BT SMOOTH
WH38X7BT	8	CROSSHEAD W/BT SMOOTH	WH44X9	9	CROSSHEAD SMOOTH
WH38X9	9	CROSSHEAD SMOOTH	WH44X9D	9	CROSSHEAD W/DT SMOOTH
WH38X9D	9	CROSSHEAD W/DT SMOOTH	WH44X9K	9	CROSSHEAD W/KEY SMOOTH
WH38X9K	9	CROSSHEAD W/KEY SMOOTH	WH44X9T	9	CROSSHEAD W/TS SMOOTH
WH38X9T	9	CROSSHEAD W/TS SMOOTH	WH45X10BT	9	CROSSHEAD W/BT SMOOTH
WH40X10BT	9	CROSSHEAD W/BT SMOOTH	WH45X9	9	CROSSHEAD SMOOTH
WH40X12	10	CROSSHEAD SMOOTH	WH45X9D	9	CROSSHEAD W/DT SMOOTH
WH40X12D	10	CROSSHEAD W/DT SMOOTH	WH45X9K	9	CROSSHEAD W/KEY SMOOTH
WH40X12K	10	CROSSHEAD W/KEY SMOOTH	WH45X9T	9	CROSSHEAD W/TS SMOOTH

INDEX

Part#	Page	Description	Part#	Page	Description
WH46X10BT	9	CROSSHEAD W/BT SMOOTH	WH54X12	10	CROSSHEAD SMOOTH
WH46X6	8	CROSSHEAD SMOOTH	WH54X12D	10	CROSSHEAD W/DT SMOOTH
WH46X6D	8	CROSSHEAD W/DT SMOOTH	WH54X12K	10	CROSSHEAD W/KEY SMOOTH
WH46X6K	8	CROSSHEAD W/KEY SMOOTH	WH54X12T	10	CROSSHEAD W/TS SMOOTH
WH46X6T	8	CROSSHEAD W/TS SMOOTH	WH54X13BT	10	CROSSHEAD W/BT SMOOTH
WH46X7BT	8	CROSSHEAD W/BT SMOOTH	WH54X6	8	CROSSHEAD SMOOTH
WH46X9	9	CROSSHEAD SMOOTH	WH54X6D	8	CROSSHEAD W/DT SMOOTH
WH46X9D	9	CROSSHEAD W/DT SMOOTH	WH54X6K	8	CROSSHEAD W/KEY SMOOTH
WH46X9K	9	CROSSHEAD W/KEY SMOOTH	WH54X6T	8	CROSSHEAD W/TS SMOOTH
WH46X9T	9	CROSSHEAD W/TS SMOOTH	WH54X7BT	8	CROSSHEAD W/BT SMOOTH
WH47X6	8	CROSSHEAD SMOOTH	WH54X9	9	CROSSHEAD SMOOTH
WH47X6D	8	CROSSHEAD W/DT SMOOTH	WH54X9D	9	CROSSHEAD W/DT SMOOTH
WH47X6K	8	CROSSHEAD W/KEY SMOOTH	WH54X9K	9	CROSSHEAD W/KEY SMOOTH
WH47X6T	8	CROSSHEAD W/TS SMOOTH	WH54X9T	9	CROSSHEAD W/TS SMOOTH
WH47X7BT	8	CROSSHEAD W/BT SMOOTH	WH56X10BT	9	CROSSHEAD W/BT SMOOTH
WH48X10BT	9	CROSSHEAD W/BT SMOOTH	WH56X12	10	CROSSHEAD SMOOTH
WH48X12	10	CROSSHEAD SMOOTH	WH56X12D	10	CROSSHEAD W/DT SMOOTH
WH48X12D	10	CROSSHEAD W/DT SMOOTH	WH56X12K	10	CROSSHEAD W/KEY SMOOTH
WH48X12K	10	CROSSHEAD W/KEY SMOOTH	WH56X12T	10	CROSSHEAD W/TS SMOOTH
WH48X12T	10	CROSSHEAD W/TS SMOOTH	WH56X13BT	10	CROSSHEAD W/BT SMOOTH
WH48X13BT	10	CROSSHEAD W/BT SMOOTH	WH56X6	8	CROSSHEAD SMOOTH
WH48X6	8	CROSSHEAD SMOOTH	WH56X6D	8	CROSSHEAD W/DT SMOOTH
WH48X6D	8	CROSSHEAD W/DT SMOOTH	WH56X6K	8	CROSSHEAD W/KEY SMOOTH
WH48X6K	8	CROSSHEAD W/KEY SMOOTH	WH56X6T	8	CROSSHEAD W/TS SMOOTH
WH48X6T	8	CROSSHEAD W/TS SMOOTH	WH56X7BT	8	CROSSHEAD W/BT SMOOTH
WH48X7BT	8	CROSSHEAD W/BT SMOOTH	WH56X9	9	CROSSHEAD SMOOTH
WH48X9	9	CROSSHEAD SMOOTH	WH56X9D	9	CROSSHEAD W/DT SMOOTH
WH48X9D	9	CROSSHEAD W/DT SMOOTH	WH56X9K	9	CROSSHEAD W/KEY SMOOTH
WH48X9K	9	CROSSHEAD W/KEY SMOOTH	WH56X9T	9	CROSSHEAD W/TS SMOOTH
WH48X9T	9	CROSSHEAD W/TS SMOOTH	WH58X10BT	9	CROSSHEAD W/BT SMOOTH
WH49X10BT	9	CROSSHEAD W/BT SMOOTH	WH58X9	9	CROSSHEAD SMOOTH
WH49X9	9	CROSSHEAD SMOOTH	WH58X9D	9	CROSSHEAD W/DT SMOOTH
WH49X9D	9	CROSSHEAD W/DT SMOOTH	WH58X9K	9	CROSSHEAD W/KEY SMOOTH
WH49X9K	9	CROSSHEAD W/KEY SMOOTH	WH58X9T	9	CROSSHEAD W/TS SMOOTH
WH49X9T	9	CROSSHEAD W/TS SMOOTH	WH60x10BT	9	CROSSHEAD W/BT SMOOTH
WH50X10BT	9	CROSSHEAD W/BT SMOOTH	WH60X6	8	CROSSHEAD SMOOTH
WH50X6	8	CROSSHEAD SMOOTH	WH60X6D	8	CROSSHEAD W/DT SMOOTH
WH50X6D	8	CROSSHEAD W/DT SMOOTH	WH60X6K	8	CROSSHEAD W/KEY SMOOTH
WH50X6K	8	CROSSHEAD W/KEY SMOOTH	WH60X6T	8	CROSSHEAD W/TS SMOOTH
WH50X6T	8	CROSSHEAD W/TS SMOOTH	WH60X7BT	8	CROSSHEAD W/BT SMOOTH
WH50X7BT	8	CROSSHEAD W/BT SMOOTH	WH60x9	9	CROSSHEAD SMOOTH
WH50X9	9	CROSSHEAD SMOOTH	WH60x9D	9	CROSSHEAD W/DT SMOOTH
WH50X9D	9	CROSSHEAD W/DT SMOOTH	WH60x9K	9	CROSSHEAD W/KEY SMOOTH
WH50X9K	9	CROSSHEAD W/KEY SMOOTH	WH60x9T	9	CROSSHEAD W/TS SMOOTH
WH50X9T	9	CROSSHEAD W/TS SMOOTH	WH62X10BT	9	CROSSHEAD W/BT SMOOTH
WH51X6	8	CROSSHEAD SMOOTH	WH62X9	9	CROSSHEAD SMOOTH
WH51X6D	8	CROSSHEAD W/DT SMOOTH	WH62X9D	9	CROSSHEAD W/DT SMOOTH
WH51X6K	8	CROSSHEAD W/KEY SMOOTH	WH62X9K	9	CROSSHEAD W/KEY SMOOTH
WH51X6T	8	CROSSHEAD W/TS SMOOTH	WH62X9T	9	CROSSHEAD W/TS SMOOTH
WH51X7BT	8	CROSSHEAD W/BT SMOOTH	WH64X10BT	9	CROSSHEAD W/BT SMOOTH
WH52X6	8	CROSSHEAD SMOOTH	WH64X12	10	CROSSHEAD SMOOTH
WH52X6D	8	CROSSHEAD W/DT SMOOTH	WH64X12D	10	CROSSHEAD W/DT SMOOTH
WH52X6K	8	CROSSHEAD W/KEY SMOOTH	WH64X12K	10	CROSSHEAD W/KEY SMOOTH
WH52X6T	8	CROSSHEAD W/TS SMOOTH	WH64X12T	10	CROSSHEAD W/TS SMOOTH
WH52X7BT	8	CROSSHEAD W/BT SMOOTH	WH64X13BT	10	CROSSHEAD W/BT SMOOTH
WH54X10BT	9	CROSSHEAD W/BT SMOOTH	WH64X6	8	CROSSHEAD SMOOTH

INDEX

Part#	Page	Description	Part#	Page	Description
WH64X6D	8	CROSSHEAD W/DT SMOOTH	WH72X12K	10	CROSSHEAD W/KEY SMOOTH
WH64X6K	8	CROSSHEAD W/KEY SMOOTH	WH72X12T	10	CROSSHEAD W/TS SMOOTH
WH64X6T	8	CROSSHEAD W/TS SMOOTH	WH72X13BT	10	CROSSHEAD W/BT SMOOTH
WH64X7BT	8	CROSSHEAD W/BT SMOOTH	WH72X6	8	CROSSHEAD SMOOTH
WH64X9	9	CROSSHEAD SMOOTH	WH72X6D	8	CROSSHEAD W/DT SMOOTH
WH64X9D	9	CROSSHEAD W/DT SMOOTH	WH72X6K	8	CROSSHEAD W/KEY SMOOTH
WH64X9K	9	CROSSHEAD W/KEY SMOOTH	WH72X6T	8	CROSSHEAD W/TS SMOOTH
WH64X9T	9	CROSSHEAD W/TS SMOOTH	WH72X7BT	8	CROSSHEAD W/BT SMOOTH
WH65X10BT	9	CROSSHEAD W/BT SMOOTH	WH72X9	9	CROSSHEAD SMOOTH
WH65X9	9	CROSSHEAD SMOOTH	WH72X9D	9	CROSSHEAD W/DT SMOOTH
WH65X9D	9	CROSSHEAD W/DT SMOOTH	WH72X9K	9	CROSSHEAD W/KEY SMOOTH
WH65X9K	9	CROSSHEAD W/KEY SMOOTH	WH72X9T	9	CROSSHEAD W/TS SMOOTH
WH65X9T	9	CROSSHEAD W/TS SMOOTH	WH73X10BT	9	CROSSHEAD W/BT SMOOTH
WH66X10BT	9	CROSSHEAD W/BT SMOOTH	WH73X6	8	CROSSHEAD SMOOTH
WH66X6	8	CROSSHEAD SMOOTH	WH73X6D	8	CROSSHEAD W/DT SMOOTH
WH66X6D	8	CROSSHEAD W/DT SMOOTH	WH73X6K	8	CROSSHEAD W/KEY SMOOTH
WH66X6K	8	CROSSHEAD W/KEY SMOOTH	WH73X6T	8	CROSSHEAD W/TS SMOOTH
WH66X6T	8	CROSSHEAD W/TS SMOOTH	WH73X7BT	8	CROSSHEAD W/BT SMOOTH
WH66X7BT	8	CROSSHEAD W/BT SMOOTH	WH73X9	9	CROSSHEAD SMOOTH
WH66X9	9	CROSSHEAD SMOOTH	WH73X9D	9	CROSSHEAD W/DT SMOOTH
WH66X9D	9	CROSSHEAD W/DT SMOOTH	WH73X9K	9	CROSSHEAD W/KEY SMOOTH
WH66X9K	9	CROSSHEAD W/KEY SMOOTH	WH73X9T	9	CROSSHEAD W/TS SMOOTH
WH66X9T	9	CROSSHEAD W/TS SMOOTH	WH74X10BT	9	CROSSHEAD W/BT SMOOTH
WH67X10BT	9	CROSSHEAD W/BT SMOOTH	WH74X6	8	CROSSHEAD SMOOTH
WH67X6	8	CROSSHEAD SMOOTH	WH74X6D	8	CROSSHEAD W/DT SMOOTH
WH67X6D	8	CROSSHEAD W/DT SMOOTH	WH74X6K	8	CROSSHEAD W/KEY SMOOTH
WH67X6K	8	CROSSHEAD W/KEY SMOOTH	WH74X6T	8	CROSSHEAD W/TS SMOOTH
WH67X6T	8	CROSSHEAD W/TS SMOOTH	WH74X7BT	8	CROSSHEAD W/BT SMOOTH
WH67X7BT	8	CROSSHEAD W/BT SMOOTH	WH74X9	9	CROSSHEAD SMOOTH
WH67X9	9	CROSSHEAD SMOOTH	WH74X9D	9	CROSSHEAD W/DT SMOOTH
WH67X9D	9	CROSSHEAD W/DT SMOOTH	WH74X9K	9	CROSSHEAD W/KEY SMOOTH
WH67X9K	9	CROSSHEAD W/KEY SMOOTH	WH74X9T	9	CROSSHEAD W/TS SMOOTH
WH67X9T	9	CROSSHEAD W/TS SMOOTH	WH75X10BT	9	CROSSHEAD W/BT SMOOTH
WH68X10BT	9	CROSSHEAD W/BT SMOOTH	WH75X9	9	CROSSHEAD SMOOTH
WH68X6	8	CROSSHEAD SMOOTH	WH75X9D	9	CROSSHEAD W/DT SMOOTH
WH68X6D	8	CROSSHEAD W/DT SMOOTH	WH75X9K	9	CROSSHEAD W/KEY SMOOTH
WH68X6K	8	CROSSHEAD W/KEY SMOOTH	WH75X9T	9	CROSSHEAD W/TS SMOOTH
WH68X6T	8	CROSSHEAD W/TS SMOOTH	WH76X10BT	9	CROSSHEAD W/BT SMOOTH
WH68X7BT	8	CROSSHEAD W/BT SMOOTH	WH76X6	8	CROSSHEAD SMOOTH
WH68X9	9	CROSSHEAD SMOOTH	WH76X6D	8	CROSSHEAD W/DT SMOOTH
WH68X9D	9	CROSSHEAD W/DT SMOOTH	WH76X6K	8	CROSSHEAD W/KEY SMOOTH
WH68X9K	9	CROSSHEAD W/KEY SMOOTH	WH76X6T	8	CROSSHEAD W/TS SMOOTH
WH68X9T	9	CROSSHEAD W/TS SMOOTH	WH76X7BT	8	CROSSHEAD W/BT SMOOTH
WH69X10BT	9	CROSSHEAD W/BT SMOOTH	WH76X9	9	CROSSHEAD SMOOTH
WH69X9	9	CROSSHEAD SMOOTH	WH76X9D	9	CROSSHEAD W/DT SMOOTH
WH69X9D	9	CROSSHEAD W/DT SMOOTH	WH76X9K	9	CROSSHEAD W/KEY SMOOTH
WH69X9K	9	CROSSHEAD W/KEY SMOOTH	WH76X9T	9	CROSSHEAD W/TS SMOOTH
WH69X9T	9	CROSSHEAD W/TS SMOOTH	WH77X10BT	9	CROSSHEAD W/BT SMOOTH
WH70X10BT	9	CROSSHEAD W/BT SMOOTH	WH77X9	9	CROSSHEAD SMOOTH
WH70X9	9	CROSSHEAD SMOOTH	WH77X9D	9	CROSSHEAD W/DT SMOOTH
WH70X9D	9	CROSSHEAD W/DT SMOOTH	WH77X9K	9	CROSSHEAD W/KEY SMOOTH
WH70X9K	9	CROSSHEAD W/KEY SMOOTH	WH77X9T	9	CROSSHEAD W/TS SMOOTH
WH70X9T	9	CROSSHEAD W/TS SMOOTH	WH78X10BT	9	CROSSHEAD W/BT SMOOTH
WH72X10BT	9	CROSSHEAD W/BT SMOOTH	WH78X6	8	CROSSHEAD SMOOTH
WH72X12	10	CROSSHEAD SMOOTH	WH78X6D	8	CROSSHEAD W/DT SMOOTH
WH72X12D	10	CROSSHEAD W/DT SMOOTH	WH78X6K	8	CROSSHEAD W/KEY SMOOTH

INDEX

Part#	Page	Description	Part#	Page	Description
WH78X6T	8	CROSSHEAD W/TS SMOOTH	WH86X7BT	8	CROSSHEAD W/BT SMOOTH
WH78X7BT	8	CROSSHEAD W/BT SMOOTH	WH86X9	9	CROSSHEAD SMOOTH
WH78X9	9	CROSSHEAD SMOOTH	WH86X9D	9	CROSSHEAD W/DT SMOOTH
WH78X9D	9	CROSSHEAD W/DT SMOOTH	WH86X9K	9	CROSSHEAD W/KEY SMOOTH
WH78X9K	9	CROSSHEAD W/KEY SMOOTH	WH86X9T	9	CROSSHEAD W/TS SMOOTH
WH78X9T	9	CROSSHEAD W/TS SMOOTH	WH87X6	8	CROSSHEAD SMOOTH
WH79X6	8	CROSSHEAD SMOOTH	WH87X6D	8	CROSSHEAD W/DT SMOOTH
WH79X6D	8	CROSSHEAD W/DT SMOOTH	WH87X6K	8	CROSSHEAD W/KEY SMOOTH
WH79X6K	8	CROSSHEAD W/KEY SMOOTH	WH87X6T	8	CROSSHEAD W/TS SMOOTH
WH79X6T	8	CROSSHEAD W/TS SMOOTH	WH87X7BT	8	CROSSHEAD W/BT SMOOTH
WH79X7BT	8	CROSSHEAD W/BT SMOOTH	WH88X10BT	9	CROSSHEAD W/BT SMOOTH
WH80.5X6	8	CROSSHEAD SMOOTH	WH88X9	9	CROSSHEAD SMOOTH
WH80.5X6D	8	CROSSHEAD W/DT SMOOTH	WH88X9D	9	CROSSHEAD W/DT SMOOTH
WH80.5X6K	8	CROSSHEAD W/KEY SMOOTH	WH88X9K	9	CROSSHEAD W/KEY SMOOTH
WH80.5X6T	8	CROSSHEAD W/TS SMOOTH	WH88X9T	9	CROSSHEAD W/TS SMOOTH
WH80.5X7BT	8	CROSSHEAD W/BT SMOOTH	WH90X10BT	9	CROSSHEAD W/BT SMOOTH
WH80X10BT	9	CROSSHEAD W/BT SMOOTH	WH90X9	9	CROSSHEAD SMOOTH
WH80X6	8	CROSSHEAD SMOOTH	WH90X9D	9	CROSSHEAD W/DT SMOOTH
WH80X6D	8	CROSSHEAD W/DT SMOOTH	WH90X9K	9	CROSSHEAD W/KEY SMOOTH
WH80X6K	8	CROSSHEAD W/KEY SMOOTH	WH90X9T	9	CROSSHEAD W/TS SMOOTH
WH80X6T	8	CROSSHEAD W/TS SMOOTH	WH93X10BT	9	CROSSHEAD W/BT SMOOTH
WH80X7BT	8	CROSSHEAD W/BT SMOOTH	WH93X9	9	CROSSHEAD SMOOTH
WH80X9	9	CROSSHEAD SMOOTH	WH93X9D	9	CROSSHEAD W/DT SMOOTH
WH80X9D	9	CROSSHEAD W/DT SMOOTH	WH93X9K	9	CROSSHEAD W/KEY SMOOTH
WH80X9K	9	CROSSHEAD W/KEY SMOOTH	WH93X9T	9	CROSSHEAD W/TS SMOOTH
WH80X9T	9	CROSSHEAD W/TS SMOOTH	WH96X10BT	9	CROSSHEAD W/BT SMOOTH
WH81X10BT	9	CROSSHEAD W/BT SMOOTH	WH96X12	10	CROSSHEAD SMOOTH
WH81X9	9	CROSSHEAD SMOOTH	WH96X12D	10	CROSSHEAD W/DT SMOOTH
WH81X9D	9	CROSSHEAD W/DT SMOOTH	WH96X12K	10	CROSSHEAD W/KEY SMOOTH
WH81X9K	9	CROSSHEAD W/KEY SMOOTH	WH96X12T	10	CROSSHEAD W/TS SMOOTH
WH81X9T	9	CROSSHEAD W/TS SMOOTH	WH96X13BT	10	CROSSHEAD W/BT SMOOTH
WH82X10BT	9	CROSSHEAD W/BT SMOOTH	WH96X6	8	CROSSHEAD SMOOTH
WH82X9	9	CROSSHEAD SMOOTH	WH96X6D	8	CROSSHEAD W/DT SMOOTH
WH82X9D	9	CROSSHEAD W/DT SMOOTH	WH96X6K	8	CROSSHEAD W/KEY SMOOTH
WH82X9K	9	CROSSHEAD W/KEY SMOOTH	WH96X6T	8	CROSSHEAD W/TS SMOOTH
WH82X9T	9	CROSSHEAD W/TS SMOOTH	WH96X7BT	8	CROSSHEAD W/BT SMOOTH
WH84X10BT	9	CROSSHEAD W/BT SMOOTH	WH96X9	9	CROSSHEAD SMOOTH
WH84X6	8	CROSSHEAD SMOOTH	WH96X9D	9	CROSSHEAD W/DT SMOOTH
WH84X6D	8	CROSSHEAD W/DT SMOOTH	WH96X9K	9	CROSSHEAD W/KEY SMOOTH
WH84X6K	8	CROSSHEAD W/KEY SMOOTH	WH96X9T	9	CROSSHEAD W/TS SMOOTH
WH84X6T	8	CROSSHEAD W/TS SMOOTH	WH99X10BT	9	CROSSHEAD W/BT SMOOTH
WH84X7BT	8	CROSSHEAD W/BT SMOOTH	WH99X9	9	CROSSHEAD SMOOTH
WH84X9	9	CROSSHEAD SMOOTH	WH99X9D	9	CROSSHEAD W/DT SMOOTH
WH84X9D	9	CROSSHEAD W/DT SMOOTH	WH99X9K	9	CROSSHEAD W/KEY SMOOTH
WH84X9K	9	CROSSHEAD W/KEY SMOOTH	WH99X9T	9	CROSSHEAD W/TS SMOOTH
WH84X9T	9	CROSSHEAD W/TS SMOOTH	WHAR101X13	15	ARCHED CROSSHEAD SMOOTH
WH85x10BT	9	CROSSHEAD W/BT SMOOTH	WHAR101X13K	15	ARCHED CROSSHEAD W/KEY SMOOTH
WH85x9	9	CROSSHEAD SMOOTH	WHAR101X14BT	15	ARCHED CROSSHEAD W/BT SMOOTH
WH85x9D	9	CROSSHEAD W/DT SMOOTH	WHAR108X19	15	ARCHED CROSSHEAD SMOOTH
WH85x9K	9	CROSSHEAD W/KEY SMOOTH	WHAR108X19K	15	ARCHED CROSSHEAD W/KEY SMOOTH
WH85x9T	9	CROSSHEAD W/TS SMOOTH	WHAR108X20BT	15	ARCHED CROSSHEAD W/BT SMOOTH
WH86X10BT	9	CROSSHEAD W/BT SMOOTH	WHAR33X14	15	ARCHED CROSSHEAD SMOOTH
WH86X6	8	CROSSHEAD SMOOTH	WHAR33X14K	15	ARCHED CROSSHEAD W/KEY SMOOTH
WH86X6D	8	CROSSHEAD W/DT SMOOTH	WHAR33X15BT	15	ARCHED CROSSHEAD W/BT SMOOTH
WH86X6K	8	CROSSHEAD W/KEY SMOOTH	WHAR36X13	15	ARCHED CROSSHEAD SMOOTH
WH86X6T	8	CROSSHEAD W/TS SMOOTH	WHAR36X13K	15	ARCHED CROSSHEAD W/KEY SMOOTH

INDEX

Part#	Page	Description	Part#	Page	Description
WHAR36X14BT	15	ARCHED CROSSHEAD W/BT SMOOTH	WHSG72X10K	11	EYEBROW CROSSHEAD W/KEY SMOOTH
WHAR43X13	15	ARCHED CROSSHEAD SMOOTH	WHSG72X11BT	11	EYEBROW CROSSHEAD W/BT SMOOTH
WHAR43X13K	15	ARCHED CROSSHEAD W/KEY SMOOTH			
WHAR43X14BT	15	ARCHED CROSSHEAD W/BT SMOOTH			
WHAR54X16	15	ARCHED CROSSHEAD SMOOTH			
WHAR54X16K	15	ARCHED CROSSHEAD W/KEY SMOOTH			
WHAR54X17BT	15	ARCHED CROSSHEAD W/BT SMOOTH			
WHAR64X14	15	ARCHED CROSSHEAD SMOOTH			
WHAR64X14K	15	ARCHED CROSSHEAD W/KEY SMOOTH			
WHAR64X15BT	15	ARCHED CROSSHEAD W/BT SMOOTH			
WHAR68X12	15	ARCHED CROSSHEAD SMOOTH			
WHAR68X12K	15	ARCHED CROSSHEAD W/KEY SMOOTH			
WHAR68X13BT	15	ARCHED CROSSHEAD W/BT SMOOTH			
WHAR68X16	15	ARCHED CROSSHEAD SMOOTH			
WHAR68X16K	15	ARCHED CROSSHEAD W/KEY SMOOTH			
WHAR68X17BT	15	ARCHED CROSSHEAD W/BT SMOOTH			
WHAR72X13	15	ARCHED CROSSHEAD SMOOTH			
WHAR72X13K	15	ARCHED CROSSHEAD W/KEY SMOOTH			
WHAR72X14BT	15	ARCHED CROSSHEAD W/BT SMOOTH			
WHAR75X13	15	ARCHED CROSSHEAD SMOOTH			
WHAR75X13K	15	ARCHED CROSSHEAD W/KEY SMOOTH			
WHAR75X14BT	15	ARCHED CROSSHEAD W/BT SMOOTH			
WHAR80X15	15	ARCHED CROSSHEAD SMOOTH			
WHAR80X15K	15	ARCHED CROSSHEAD W/KEY SMOOTH			
WHAR80X16BT	15	ARCHED CROSSHEAD W/BT SMOOTH			
WHAR84X16	15	ARCHED CROSSHEAD SMOOTH			
WHAR84X16K	15	ARCHED CROSSHEAD W/KEY SMOOTH			
WHAR84X17BT	15	ARCHED CROSSHEAD W/BT SMOOTH			
WHAR89X13	15	ARCHED CROSSHEAD SMOOTH			
WHAR89X13K	15	ARCHED CROSSHEAD W/KEY SMOOTH			
WHAR89X14BT	15	ARCHED CROSSHEAD W/BT SMOOTH			
WHAR97X17	15	ARCHED CROSSHEAD SMOOTH			
WHAR97X17K	15	ARCHED CROSSHEAD W/KEY SMOOTH			
WHAR97X18BT	15	ARCHED CROSSHEAD W/BT SMOOTH			
WHSG28X10	11	EYEBROW CROSSHEAD SMOOTH			
WHSG28X10K	11	EYEBROW CROSSHEAD W/KEY SMOOTH			
WHSG28X11BT	11	EYEBROW CROSSHEAD W/BT SMOOTH			
WHSG30X10	11	EYEBROW CROSSHEAD SMOOTH			
WHSG30X10K	11	EYEBROW CROSSHEAD W/KEY SMOOTH			
WHSG30X11BT	11	EYEBROW CROSSHEAD W/BT SMOOTH			
WHSG34X10	11	EYEBROW CROSSHEAD SMOOTH			
WHSG34X10K	11	EYEBROW CROSSHEAD W/KEY SMOOTH			
WHSG34X11BT	11	EYEBROW CROSSHEAD W/BT SMOOTH			
WHSG36X10	11	EYEBROW CROSSHEAD SMOOTH			
WHSG36X10K	11	EYEBROW CROSSHEAD W/KEY SMOOTH			
WHSG36X11BT	11	EYEBROW CROSSHEAD W/BT SMOOTH			
WHSG43X10	11	EYEBROW CROSSHEAD SMOOTH			
WHSG43X10K	11	EYEBROW CROSSHEAD W/KEY SMOOTH			
WHSG43X11BT	11	EYEBROW CROSSHEAD W/BT SMOOTH			
WHSG44X10	11	EYEBROW CROSSHEAD SMOOTH			
WHSG44X10K	11	EYEBROW CROSSHEAD W/KEY SMOOTH			
WHSG44X11BT	11	EYEBROW CROSSHEAD W/BT SMOOTH			
WHSG64X10	11	EYEBROW CROSSHEAD SMOOTH			
WHSG64X10K	11	EYEBROW CROSSHEAD W/KEY SMOOTH			
WHSG64X11BT	11	EYEBROW CROSSHEAD W/BT SMOOTH			
WHSG72X10	11	EYEBROW CROSSHEAD SMOOTH			



Legen

- Legen(Yantai) Architectural Millwork Co., Ltd.
- Web: legenpu.com
- E-mail: sales@legenpu.com
- Phone:+86-535-6801844
- Fax:+86-535-6801844
- No.5 LiJing Road, FuShan District,Yantai, Shandong, PRC

